

# سایت اختصاصی مهندسی کنترل

 <https://controlengineers.ir>

 @controlengineers



# Nonlinear Systems

Third Edition

# 非线性系统

(第三版)

---

## Solutions Manual

---

Hassan K. Khalil



電子工業出版社  
Publishing House of Electronics Industry  
<http://www.phei.com.cn>

## 《非线性系统（第三版）》习题解答

### Chapter 1

- 1.1 Let  $x_1 = y, x_2 = y^{(1)}, \dots, x_n = y^{(n-1)}$ .

$$\begin{aligned}
 \dot{x}_1 &= x_2 \\
 &\vdots \\
 \dot{x}_{n-1} &= x_n \\
 \dot{x}_n &= g(t, x_1, \dots, x_n, u) \\
 y &= x_1
 \end{aligned}$$

- 1.2 Let  $x_1 = y, x_2 = y^{(1)}, \dots, x_{n-1} = y^{(n-2)}, x_n = y^{(n-1)} - g_2(t, y, y^{(1)}, \dots, y^{(n-2)})u$ .

$$\begin{aligned}
 \dot{x}_1 &= x_2 \\
 &\vdots \\
 \dot{x}_{n-2} &= x_{n-1} \\
 \dot{x}_{n-1} &= y^{(n-1)} = x_n + g_2(t, x_1, x_2, \dots, x_{n-1})u \\
 \dot{x}_n &= y^{(n)} - g_2(t, x_1, \dots, x_{n-1})\dot{u} - \left( \frac{\partial g_2}{\partial t} + \frac{\partial g_2}{\partial x_1} \dot{x}_1 + \dots + \frac{\partial g_2}{\partial x_{n-1}} \dot{x}_{n-1} \right) u \\
 &= g_1(t, x_1, \dots, x_{n-1}, x_n + g_2(\cdot)u, u) \\
 &\quad - \left( \frac{\partial g_2}{\partial t} + \frac{\partial g_2}{\partial x_1} x_2 + \dots + \frac{\partial g_2}{\partial x_{n-1}} (x_n + g_2(\cdot)u) \right) u \\
 y &= x_1
 \end{aligned}$$

- 1.3 Let  $x_1 = y, x_2 = y^{(1)}, \dots, x_n = y^{(n-1)}, x_{n+1} = z, \dots, x_{n+m} = z^{(m-1)}$ .

$$\begin{aligned}
 \dot{x}_1 &= x_2 \\
 &\vdots \\
 \dot{x}_{n-1} &= x_n \\
 \dot{x}_n &= g(x_1, \dots, x_n, x_{n+1}, \dots, x_{n+m}, u) \\
 \dot{x}_{n+1} &= x_{n+2} \\
 &\vdots \\
 \dot{x}_{n+m-1} &= x_{n+m} \\
 \dot{x}_{n+m} &= u \\
 y &= x_1
 \end{aligned}$$

## 《非线性系统（第三版）》习题解答

• 1.4 Let  $x_1 = q, x_2 = \dot{q}, x = \begin{bmatrix} x_1 \\ x_2 \end{bmatrix} \in R^{2m}$ .

$$\begin{aligned} \dot{x}_1 &= x_2 \\ \dot{x}_2 &= \ddot{q} = M^{-1}(x_1)[u - C(x_1, x_2)x_2 - Dx_2 - g(x_1)] \end{aligned}$$

• 1.5 Let  $x_1 = q_1, x_2 = \dot{q}_1, x_3 = q_2, x_4 = \dot{q}_2$ .

$$\begin{aligned} \dot{x}_1 &= x_2 \\ \dot{x}_2 &= -\frac{MgL}{I} \sin x_1 - \frac{k}{I}(x_1 - x_3) \\ \dot{x}_3 &= x_4 \\ \dot{x}_4 &= \frac{k}{J}(x_1 - x_3) + \frac{1}{J}u \end{aligned}$$

• 1.6 Let  $x_1 = q_1, x_2 = \dot{q}_1, x_3 = q_2, x_4 = \dot{q}_2$ , where  $x_i \in R^m$ .

$$\begin{aligned} \dot{x}_1 &= x_2 \\ \dot{x}_2 &= -M^{-1}(x_1)[h(x_1, x_2) + K(x_1 - x_3)] \\ \dot{x}_3 &= x_4 \\ \dot{x}_4 &= J^{-1}K(x_1 - x_3) + J^{-1}u \end{aligned}$$

• 1.7 Let

$$\dot{x} = Ax + Bu, \quad y = Cx$$

be a state model of the linear system.

$$u = r - \psi(t, y) = r - \psi(t, Cx)$$

Hence

$$\dot{x} = Ax - B\psi(t, Cx) + Br, \quad y = Cx$$

• 1.8 (a) Let  $x_1 = \delta, x_2 = \dot{\delta}, x_3 = E\delta$ , and  $u = EFD$ .

$$\begin{aligned} \dot{x}_1 &= x_2 \\ \dot{x}_2 &= \frac{P}{M} - \frac{D}{M}x_2 - \frac{\eta_1}{M}x_3 \sin x_1 \\ \dot{x}_3 &= -\frac{\eta_2}{\tau}x_3 + \frac{\eta_3}{\tau} \cos x_1 + \frac{1}{\tau}u \end{aligned}$$

(b) The equilibrium points are the roots of the equations

$$\begin{aligned} 0 &= x_2 \\ 0 &= 0.815 - Dx_2 - 2.0x_3 \sin x_1 \\ 0 &= -2.7x_3 + 1.7 \cos x_1 + 1.22 \end{aligned}$$

$$x_2 = 0 \Rightarrow x_3 = \frac{0.4075}{\sin x_1}$$

Substituting  $x_3$  in the third equation yields

$$(1.22 + 1.7 \cos x_1) \sin x_1 - 1.10025 = 0$$

The foregoing equation has two roots  $x_1 = 0.4067$  and  $x_1 = 1.6398$  in the interval  $-\pi \leq x_1 \leq \pi$ . Due to periodicity,  $0.4067 + 2n\pi$  and  $1.6398 + 2n\pi$  are also roots for  $n = \pm 1, \pm 2, \dots$ . Each root  $x_1 = x$  gives an

## 《非线性系统（第三版）》习题解答

equilibrium point  $(x, 0, 0.4075/\sin x)$ .

(c) With  $E_q = \text{constant}$ , the model reduces to

$$\begin{aligned}\dot{x}_1 &= x_2 \\ \dot{x}_2 &= \frac{P}{M} - \frac{D}{M}x_2 - \frac{\eta_1}{M}E_q \sin x_1\end{aligned}$$

which is a pendulum equation with an input torque.

• 1.9 (a) Let  $x_1 = \phi_L$ ,  $x_2 = v_C$ .

$$\begin{aligned}\dot{x}_1 &= \dot{\phi}_L = v_L = v_C = x_2 \\ \dot{x}_2 &= \dot{v}_C = \frac{1}{C}i_C = \frac{1}{C}\left[i_s - \frac{v_C}{R} - i_L\right] \\ &= \frac{1}{C}\left[i_s - I_0 \sin kx_1 - \frac{1}{R}x_2\right]\end{aligned}$$

(b) Let  $x_1 = i_L$ ,  $x_2 = v_C$ .

$$\begin{aligned}\dot{x}_1 &= I_0 k \cos k\phi_L \dot{\phi}_L = k\sqrt{I_0^2 - i_L^2}v_C \\ &= x_2 k\sqrt{I_0^2 - x_1^2} \\ \dot{x}_2 &= \frac{1}{C}\left[i_s - x_1 - \frac{1}{R}x_2\right]\end{aligned}$$

The model of (a) is more familiar since it is the pendulum equation.

• 1.10 (a) Let  $x_1 = \phi_L$ ,  $x_2 = v_C$ .

$$\begin{aligned}\dot{x}_1 &= \dot{\phi}_L = v_L = v_C = x_2 \\ \dot{x}_2 &= \dot{v}_C = \frac{1}{C}i_C = \frac{1}{C}\left[i_s - \frac{v_C}{R} - i_L\right] \\ &= \frac{1}{C}\left[i_s - Lx_1 - \mu x_1^3 - \frac{1}{R}x_2\right]\end{aligned}$$

(b)  $x_2 = 0 \Rightarrow Lx_1 + \mu x_1^3 = 0 \Rightarrow x_1 = 0$ . There is a unique equilibrium point at the origin.

• 1.11 (a)

$$\begin{aligned}z &= Az + Bu, \quad y = Cx, \quad u = \sin e \\ \dot{e} &= \dot{\theta}_i - \dot{\theta}_o = -\dot{\theta}_o = -y = -Cz \\ z &= Az + B \sin e, \quad \dot{e} = -Cz\end{aligned}$$

(b)

$$\begin{aligned}0 &= Az + B \sin e \Rightarrow z = -A^{-1}B \sin e \\ 0 &= Cz \Rightarrow -CA^{-1}B \sin e = G(0) \sin e = 0\end{aligned}$$

$$G(0) \neq 0 \Rightarrow \sin e = 0 \Rightarrow e = \pm n\pi, \quad n = 0, 1, 2, \dots \quad \text{and } z = 0$$

(c) For  $G(s) = 1/(\tau s + 1)$ , take  $A = -1/\tau$ ,  $B = 1/\tau$  and  $C = 1$ . Then

$$\dot{z} = -\frac{1}{\tau}z + \frac{1}{\tau} \sin e, \quad \dot{e} = -z$$

Let  $x_1 = e$ ,  $x_2 = -z$ .

$$\dot{x}_1 = x_2, \quad \dot{x}_2 = -\frac{1}{\tau}x_2 - \frac{1}{\tau} \sin x_1$$

## 《非线性系统（第三版）》习题解答

- 1.12 The equation of motion is

$$M\ddot{y} = Mg - ky - c_1\dot{y} - c_2\dot{y}|\dot{y}|$$

Let  $x_1 = y$  and  $x_2 = \dot{y}$ .

$$\dot{x}_1 = x_2, \quad \dot{x}_2 = -\frac{k}{M}x_1 - \frac{c_1}{M}x_2 - \frac{c_2}{M}x_2|x_2| + g$$

- 1.13 (a)

$$m\ddot{y} = -(k_1 + k_2)y - c\dot{y} + h(v_0 - \dot{y})$$

where  $c > 0$  is the viscous friction coefficient.

(b)  $h(v) \approx h(v_0) - h'(v_0)\dot{y}$ .

$$m\ddot{y} = -(k_1 + k_2)y - [c + h'(v_0)]\dot{y} + h(v_0)$$

(c) To obtain negative friction, we want  $c + h'(v_0) < 0$ . This can be achieved with the friction characteristic of Figure 1.5(d) if  $v_0$  is in the range where the slope is negative and the magnitude of the negative slope is greater than  $c$ .

- 1.14 The equation of motion is

$$M\dot{v} = F - Mg \sin \theta - k_1 \text{sgn}(v) - k_2v - k_3v^2$$

where  $k_1$ ,  $k_2$ , and  $k_3$  are positive constants. Let  $x = v$ ,  $u = F$ , and  $w = \sin \theta$ .

$$\dot{x} = \frac{1}{M} [-k_1 \text{sgn}(x) - k_2x - k_3x^2 + u] - gw$$

- 1.15 (a)

$$H = m \frac{d^2}{dt^2}(y + L \sin \theta) = m \frac{d}{dt}(\dot{y} + L\dot{\theta} \cos \theta) = m(\ddot{y} + L\ddot{\theta} \cos \theta - L\dot{\theta}^2 \sin \theta)$$

$$V = m \frac{d^2}{dt^2}(L \cos \theta) + mg = m \frac{d}{dt}(-L\dot{\theta} \sin \theta) + mg = -mL\ddot{\theta} \sin \theta - mL\dot{\theta}^2 \cos \theta + mg$$

Substituting  $V$  and  $H$  in the  $\ddot{\theta}$ -equation yields

$$\begin{aligned}
 I\ddot{\theta} &= VL \sin \theta - HL \cos \theta \\
 &= -mL^2\ddot{\theta}(\sin \theta)^2 - mL^2\dot{\theta}^2 \sin \theta \cos \theta + mgL \sin \theta \\
 &\quad - mL\ddot{y} \cos \theta - mL^2\ddot{\theta}(\cos \theta)^2 + mL^2\dot{\theta}^2 \sin \theta \cos \theta \\
 &= -mL^2\ddot{\theta}[(\sin \theta)^2 + (\cos \theta)^2] + mgL \sin \theta - mL\ddot{y} \cos \theta \\
 &= -mL^2\ddot{\theta} + mgL \sin \theta - mL\ddot{y} \cos \theta
 \end{aligned}$$

Substituting  $H$  in the  $\ddot{y}$ -equation yields

$$M\ddot{y} = F - m(\ddot{y} + L\ddot{\theta} \cos \theta - L\dot{\theta}^2 \sin \theta) - k\dot{y}$$

(b)

$$D(\theta) \begin{bmatrix} \ddot{\theta} \\ \ddot{y} \end{bmatrix} = \begin{bmatrix} mgL \sin \theta \\ F + mL\dot{\theta}^2 \sin \theta - k\dot{y} \end{bmatrix}$$

where

$$D(\theta) = \begin{bmatrix} I + mL^2 & mL \cos \theta \\ mL \cos \theta & m + M \end{bmatrix}$$

$$\det(D(\theta)) = (I + mL^2)(m + M) - m^2L^2 \cos^2 \theta = \Delta(\theta)$$

## 《非线性系统（第三版）》习题解答

Hence,

$$D^{-1}(\theta) = \frac{1}{\Delta(\theta)} \begin{bmatrix} m+M & -mL \cos \theta \\ -mL \cos \theta & I+mL^2 \end{bmatrix}$$

$$\begin{bmatrix} \ddot{\theta} \\ \ddot{y} \end{bmatrix} = \frac{1}{\Delta(\theta)} \begin{bmatrix} m+M & -mL \cos \theta \\ -mL \cos \theta & I+mL^2 \end{bmatrix} \begin{bmatrix} mgL \sin \theta \\ F+mL\dot{\theta}^2 \sin \theta - ky \end{bmatrix}$$

(c)

$$\begin{aligned} \dot{x}_1 &= x_2 \\ \dot{x}_2 &= \ddot{\theta} = \frac{1}{\Delta(\theta)} [(m+M)mgL \sin \theta - mL \cos \theta (F+mL\dot{\theta}^2 \sin \theta - ky)] \\ &= \frac{1}{\Delta(x_1)} [(m+M)mgL \sin x_1 - mL \cos x_1 (u+mLx_2^2 \sin x_1 - kx_4)] \\ \dot{x}_3 &= x_4 \\ \dot{x}_4 &= \ddot{y} = \frac{1}{\Delta(\theta)} [-m^2L^2g \sin \theta \cos \theta + (I+mL^2)(F+mL\dot{\theta}^2 \sin \theta - ky)] \\ &= \frac{1}{\Delta(x_1)} [-m^2L^2g \sin x_1 \cos x_1 + (I+mL^2)(u+mLx_2^2 \sin x_1 - kx_4)] \end{aligned}$$

• 1.16 (a)

$$F_x = m \frac{d^2}{dt^2} (x_c + L \sin \theta) = m \frac{d}{dt} (\dot{x}_c + L\dot{\theta} \cos \theta) = m(\ddot{x}_c + L\ddot{\theta} \cos \theta - L\dot{\theta}^2 \sin \theta)$$

$$F_y = m \frac{d^2}{dt^2} (L \cos \theta) = m \frac{d}{dt} (-L\dot{\theta} \sin \theta) = -mL\ddot{\theta} \sin \theta - mL\dot{\theta}^2 \cos \theta$$

Substituting  $F_x$  and  $F_y$  in the  $\ddot{\theta}$ -equation yields

$$\begin{aligned} I\ddot{\theta} &= u + F_y L \sin \theta - F_x L \cos \theta \\ &= u - mL^2 \ddot{\theta} (\sin \theta)^2 - mL^2 \dot{\theta}^2 \sin \theta \cos \theta \\ &\quad - mL\ddot{x}_c \cos \theta - mL^2 \ddot{\theta} (\cos \theta)^2 + mL^2 \dot{\theta}^2 \sin \theta \cos \theta \\ &= u - mL^2 \ddot{\theta} [(\sin \theta)^2 + (\cos \theta)^2] - mL\ddot{x}_c \cos \theta \\ &= u - mL^2 \ddot{\theta} - mL\ddot{x}_c \cos \theta \end{aligned}$$

Substituting  $F_x$  in the  $\ddot{x}_c$ -equation yields

$$M\ddot{x}_c = -m\ddot{x}_c - mL\ddot{\theta} \cos \theta + mL\dot{\theta}^2 \sin \theta - kx_c$$

Thus,

$$D(\theta) \begin{bmatrix} \ddot{\theta} \\ \ddot{x}_c \end{bmatrix} = \begin{bmatrix} u \\ mL\dot{\theta}^2 \sin \theta - kx_c \end{bmatrix}$$

where

$$D(\theta) = \begin{bmatrix} I+mL^2 & mL \cos \theta \\ mL \cos \theta & m+M \end{bmatrix}$$

(b)

$$\det(D(\theta)) = (I+mL^2)(m+M) - m^2L^2 \cos^2 \theta = \Delta(\theta)$$

Hence,

$$D^{-1}(\theta) = \frac{1}{\Delta(\theta)} \begin{bmatrix} m+M & -mL \cos \theta \\ -mL \cos \theta & I+mL^2 \end{bmatrix}$$

## 《非线性系统（第三版）》习题解答

$$\begin{bmatrix} \ddot{\theta} \\ \dot{x}_c \end{bmatrix} = \frac{1}{\Delta(\theta)} \begin{bmatrix} m+M & -mL \cos \theta \\ -mL \cos \theta & I+mL^2 \end{bmatrix} \begin{bmatrix} u \\ mL\dot{\theta}^2 \sin \theta - kx_c \end{bmatrix}$$

(c)

$$\begin{aligned} \dot{x}_1 &= x_2 \\ \dot{x}_2 &= \ddot{\theta} = \frac{1}{\Delta(\theta)} [(m+M)u - mL \cos \theta (mL\dot{\theta}^2 \sin \theta - kx_c)] \\ &= \frac{1}{\Delta(x_1)} [(m+M)u - mL \cos x_1 (mLx_2^2 \sin x_1 - kx_3)] \\ \dot{x}_3 &= x_4 \\ \dot{x}_4 &= \dot{x}_c = \frac{1}{\Delta(\theta)} [-mLu \cos \theta + (I+mL^2)(mL\dot{\theta}^2 \sin \theta - kx_c)] \\ &= \frac{1}{\Delta(x_1)} [-mLu \cos x_1 + (I+mL^2)(mLx_2^2 \sin x_1 - kx_3)] \end{aligned}$$

(d) Take  $u = \text{constant}$ . Setting the derivatives  $\dot{x}_i = 0$ , we obtain  $x_2 = x_4 = 0$  and

$$\begin{aligned} 0 &= (m+M)u + mLx_3 \cos x_1 \\ 0 &= -mLu \cos x_1 - k(I+mL^2)x_3 \end{aligned}$$

Eliminating  $x_3$  between the two equations yields

$$u[(m+M)(I+mL^2) - m^2L^2 \cos^2 x_1] = u \Delta(x_1) = 0$$

Since  $\Delta(x_1) > 0$ , equilibrium can be maintained only at  $u = 0$ . Then,  $x_3 = 0$ . Thus, the system has an equilibrium set  $\{x_2 = x_3 = x_4 = 0\}$ .

• 1.17 (a) Let  $x_1 = i_f$ ,  $x_2 = i_a$ , and  $x_3 = \omega$ .

$$\begin{aligned} \dot{x}_1 &= -\frac{R_f}{L_f}x_1 + \frac{v_f}{L_f} \\ \dot{x}_2 &= -\frac{R_a}{L_a}x_2 - \frac{c_1}{L_a}x_1x_3 + \frac{v_a}{L_a} \\ \dot{x}_3 &= -\frac{c_3}{J}x_3 + \frac{c_2}{J}x_1x_2 \end{aligned}$$

(b) Take  $v_a = V_a = \text{constant}$  and  $v_f = u$ .

(c) Take  $v_f = V_f = \text{constant}$  and  $v_a = u$ . A constant field voltage implies that (at steady state)  $i_f = V_f/R_f \stackrel{\text{def}}{=} I_f = \text{constant}$ . Hence, the model reduces to the second-order linear model

$$\begin{aligned} \dot{x}_2 &= -\frac{R_a}{L_a}x_2 - \frac{c_1 I_f}{L_a}x_3 + \frac{u}{L_a} \\ \dot{x}_3 &= -\frac{c_3}{J}x_3 + \frac{c_2 I_f}{J}x_2 \end{aligned}$$

(d) Let  $v = u$ .

$$\begin{aligned} \dot{x}_1 &= -\frac{R_a + R_f}{L_f}x_1 + \frac{u}{L_f} \\ \dot{x}_2 &= -\frac{R_a}{L_a}x_2 - \frac{c_1}{L_a}x_1x_3 + \frac{u}{L_a} \\ \dot{x}_3 &= -\frac{c_3}{J}x_3 + \frac{c_2}{J}x_1x_2 \end{aligned}$$



## 《非线性系统（第三版）》习题解答

• 1.18 (a)  $x_1 = y, x_2 = \dot{y}, x_3 = i, u = v.$

$$\begin{aligned}
 \dot{x}_1 &= x_2 \\
 \dot{x}_2 &= \ddot{y} = -\frac{k}{m}\dot{y} + g + \frac{1}{m}F(y, i) \\
 &= g - \frac{k}{m}x_2 - \frac{1}{m} \cdot \frac{L_0 x_3^2}{2a(1+x_1/a)^2} \\
 &= g - \frac{k}{m}x_2 - \frac{L_0 a x_3^2}{2m(a+x_1)^2} \\
 \dot{x}_3 &= \frac{di}{dt} = \frac{d}{dt} \left[ \frac{\phi}{L(y)} \right] \\
 &= \frac{\dot{\phi}}{L(y)} - \frac{\phi}{L^2(y)} \cdot \frac{dL}{dy} \dot{y} \\
 &= \frac{1}{L(y)}(v - Ri) + \frac{\phi}{L^2(y)} \cdot \frac{L_0}{a(1+y/a)^2} \dot{y} \\
 &= \frac{1}{L(x_1)} \left[ -Rx_3 + \frac{L_0 a x_2 x_3}{(a+x_1)^2} + u \right]
 \end{aligned}$$

(b) The equilibrium equations are

$$\begin{aligned}
 0 &= \bar{x}_2 \\
 0 &= g - \frac{k}{m}\bar{x}_2 - \frac{L_0 a \bar{x}_3^2}{2m(a+\bar{x}_1)^2} \\
 0 &= -R\bar{x}_3 + \frac{L_0 a \bar{x}_2 \bar{x}_3}{(a+\bar{x}_1)^2} + \bar{u}
 \end{aligned}$$

Set  $\bar{x}_1 = r, \bar{x}_3 = I_{ss},$  and  $\bar{u} = V_{ss}.$  Then

$$I_{ss} = \left( \frac{2mg(a+r)^2}{L_0 a} \right)^{1/2}, \quad V_{ss} = RI_{ss}$$

• 1.19 (a)

$$\begin{aligned}
 \frac{d}{dt} \left( \int_0^h A(\lambda) d\lambda \right) &= w_i - k\sqrt{\rho g h} \\
 A(h)\dot{h} &= u - k\sqrt{\rho g h}
 \end{aligned}$$

Let  $x = h.$

$$\dot{x} = \frac{1}{A(x)}[u - k\sqrt{\rho g x}], \quad y = x$$

(b)  $x = p - p_0 = \rho g h.$

$$\dot{x} = \frac{\rho g}{A(x/\rho g)}(u - k\sqrt{x}), \quad y = x/(\rho g)$$

(c) At equilibrium,

$$0 = u_{ss} - k\sqrt{\rho g x_{ss}}, \quad y_{ss} = x_{ss} = r$$

Hence,  $u_{ss} = k\sqrt{\rho g r}$

## 《非线性系统（第三版）》习题解答

- 1.20 (a) From the equations  $\dot{v} = w_i - w_o$  and  $p = p_o + (\rho g/A)v$ , we have

$$\dot{p} = \frac{\rho g}{A} \dot{v} = \frac{\rho g}{A} (w_i - w_o) = \frac{\rho g}{A} [\phi^{-1}(\Delta p) - k\sqrt{\Delta p}]$$

Using  $x = \Delta p$  as the state variable, we obtain

$$\dot{x} = \frac{\rho g}{A} [\phi^{-1}(x) - k\sqrt{x}]$$

- (b) At equilibrium we have

$$\phi^{-1}(\bar{x}) = k\sqrt{\bar{x}}$$

Writing  $\bar{x} = \phi(\bar{w}_i)$ , we can rewrite the previous equation as

$$w_i = k\sqrt{\phi(\bar{w}_i)}$$

Hence,

$$\left(\frac{\bar{w}_i}{k}\right)^2 = \phi(\bar{w}_i)$$

The solutions of this equation are given by the intersection of the curve  $(\bar{w}_i/k)^2$  with the curve  $\phi(\bar{w}_i)$ , which is shown in Figure 1.29 of the text. From the figure, it is clear that there is only one intersection point.

- 1.21 (a) We have

$$\dot{w}_1 = w_p - w_1, \quad \dot{w}_2 = w_1 - w_2$$

$$\dot{p}_1 = \frac{\rho g}{A_1} \dot{w}_1, \quad \dot{p}_2 = \frac{\rho g}{A_2} \dot{w}_2$$

$$w_1 = k_1 \sqrt{p_1 - p_a}, \quad w_2 = k_2 \sqrt{p_2 - p_a}, \quad p_1 - p_a = \phi(w_p)$$

Let  $x_1 = p_1 - p_a$  and  $x_2 = p_2 - p_a$ .

$$\dot{x}_1 = \dot{p}_1 = \frac{\rho g}{A_1} (w_p - w_1) = \frac{\rho g}{A_1} [\phi^{-1}(x_1) - k_1 \sqrt{x_1 - x_2}]$$

$$\dot{x}_2 = \dot{p}_2 = \frac{\rho g}{A_2} (w_1 - w_2) = \frac{\rho g}{A_2} [k_1 \sqrt{x_1 - x_2} - k_2 \sqrt{x_2}]$$

- (b) The equilibrium equations are

$$\begin{aligned} \phi^{-1}(\bar{x}_1) &= k_1 \sqrt{\bar{x}_1 - \bar{x}_2} \\ k_1 \sqrt{\bar{x}_1 - \bar{x}_2} &= k_2 \sqrt{\bar{x}_2} \end{aligned}$$

From the second equation, we have

$$\bar{x}_2 = \frac{k_1^2}{k_1^2 + k_2^2} \bar{x}_1$$

Substituting this expression in the first equilibrium equation yields

$$\phi^{-1}(\bar{x}_1) = k_{\text{eq}} \sqrt{\bar{x}_1}, \quad \text{where } k_{\text{eq}} = \frac{k_1 k_2}{\sqrt{k_1^2 + k_2^2}}$$

Writing  $\bar{x}_1 = \phi(\bar{w}_p)$ , we can rewrite the previous equation as

$$\bar{w}_p = k_{\text{eq}} \sqrt{\phi(\bar{w}_p)}$$

Hence,

$$\left(\frac{\bar{w}_p}{k_{\text{eq}}}\right)^2 = \phi(\bar{w}_p)$$

The solutions of this equation are given by the intersection of the curve  $(\bar{w}_p/k_{\text{eq}})^2$  with the curve  $\phi(\bar{w}_p)$ , which is shown in Figure 1.29 of the text. From the figure, it is clear that there is only one intersection point.

## 《非线性系统（第三版）》习题解答

• 1.22 (a)

$$\begin{aligned}\dot{x}_1 &= dx_{1f} - dx_1 + r_1 \\ \dot{x}_2 &= dx_{2f} - dx_2 - r_2\end{aligned}$$

The assumptions  $r_1 = \mu x_1$ ,  $r_2 = r_1/Y = \mu x_1/Y$ , and  $x_{1f} = 0$  yield

$$\begin{aligned}\dot{x}_1 &= (\mu - d)x_1 \\ \dot{x}_2 &= d(x_{2f} - x_2) - \mu x_1/Y\end{aligned}$$

(b) When  $\mu = \mu_m x_2/(k_m + x_2)$ , the equilibrium equations are

$$\begin{aligned}0 &= \left( \frac{\mu_m \bar{x}_2}{k_m + \bar{x}_2} - d \right) \bar{x}_1 \\ 0 &= d(x_{2f} - \bar{x}_2) - \frac{\mu_m \bar{x}_1 \bar{x}_2}{Y(k_m + \bar{x}_2)}\end{aligned}$$

from the first equation,

$$\bar{x}_1 = 0 \text{ or } \frac{\mu_m \bar{x}_2}{k_m + \bar{x}_2} = d \Rightarrow \bar{x}_2 = \frac{k_m d}{\mu_m - d}$$

Substituting  $\bar{x}_1 = 0$  in the second equilibrium equation yields  $\bar{x}_2 = x_{2f}$ . Substituting  $\bar{x}_2 = k_m d/(\mu_m - d)$  in the second equilibrium equation yields

$$\bar{x}_1 = Y \left( x_{2f} - \frac{k_m d}{\mu_m - d} \right)$$

Hence, there are two equilibrium points at

$$\left( Y \left( x_{2f} - \frac{k_m d}{\mu_m - d} \right), \frac{k_m d}{\mu_m - d} \right) \text{ and } (0, x_{2f})$$

(c) When  $\mu = \mu_m x_2/(k_m + x_2 + k_1 x_2^2)$ , the equilibrium equations are

$$\begin{aligned}0 &= \left( \frac{\mu_m \bar{x}_2}{k_m + \bar{x}_2 + k_1 \bar{x}_2^2} - d \right) \bar{x}_1 \\ 0 &= d(x_{2f} - \bar{x}_2) - \frac{\mu_m \bar{x}_1 \bar{x}_2}{Y(k_m + \bar{x}_2 + k_1 \bar{x}_2^2)}\end{aligned}$$

from the first equation,  $\bar{x}_1 = 0$  or  $\bar{x}_2$  is the root of  $d = \mu(\bar{x}_2)$ . Since  $d < \max_{x_2 \geq 0} \{\mu(x_2)\}$ , the equation  $d = \mu(\bar{x}_2)$  has two roots. Denote these roots by  $\bar{x}_{2a}$  and  $\bar{x}_{2b}$ . Substituting  $\bar{x}_1 = 0$  in the second equilibrium equation yields  $\bar{x}_2 = x_{2f}$ . Substituting  $\bar{x}_2 = \bar{x}_{2a}$  in the second equilibrium equation yields

$$d(x_{2f} - \bar{x}_{2a}) - \mu(\bar{x}_{2a})\bar{x}_1/Y = 0 \Rightarrow \bar{x}_1 = Y(x_{2f} - \bar{x}_{2a})$$

since  $\mu(\bar{x}_{2a}) = d$ . Similarly, substituting  $\bar{x}_2 = \bar{x}_{2b}$  in the second equilibrium equation yields  $\bar{x}_1 = Y(x_{2f} - \bar{x}_{2b})$ . Thus, there are three equilibrium points at

$$(Y(x_{2f} - \bar{x}_{2a}), \bar{x}_{2a}), (Y(x_{2f} - \bar{x}_{2b}), \bar{x}_{2b}), \text{ and } (0, x_{2f})$$

## 《非线性系统（第三版）》习题解答

---

Controlengineers.ir

## 《非线性系统（第三版）》习题解答

### Chapter 2

• 2.1 (1)

$$0 = -x_1 + 2x_1^2 + x_2, \quad 0 = -x_1 - x_2$$

$$x_2 = -x_1 \Rightarrow 0 = 2x_1(x_1^2 - 1) \Rightarrow x_1 = 0, 1, \text{ or } -1$$

There are three equilibrium points at  $(0,0)$ ,  $(1,-1)$ , and  $(-1,1)$ . Determine the type of each point using linearization.

$$\frac{\partial f}{\partial x} = \begin{bmatrix} -1 + 6x_1^2 & 1 \\ -1 & -1 \end{bmatrix}$$

$$\left. \frac{\partial f}{\partial x} \right|_{(0,0)} = \begin{bmatrix} -1 & 1 \\ -1 & -1 \end{bmatrix} \Rightarrow \lambda_{1,2} = -1 \pm j \Rightarrow (0,0) \text{ is a stable focus}$$

$$\left. \frac{\partial f}{\partial x} \right|_{(1,-1)} = \begin{bmatrix} 5 & 1 \\ -1 & -1 \end{bmatrix} \Rightarrow \lambda_{1,2} = 2 \pm \sqrt{8} \Rightarrow (1,-1) \text{ is a saddle}$$

Similarly,  $(-1,1)$  is a saddle.

(2)

$$0 = x_1(1 + x_2), \quad 0 = -x_2 + x_2^2 + x_1x_2 - x_1^3$$

$$0 = x_1(1 + x_2) \Rightarrow x_1 = 0 \text{ or } x_2 = -1$$

$$x_1 = 0 \Rightarrow 0 = -x_2 + x_2^2 \Rightarrow x_2 = 0 \text{ or } x_2 = 1$$

$$x_2 = -1 \Rightarrow 0 = 2 - x_1 - x_1^3 \Rightarrow x_1 = 1$$

There are three equilibrium points at  $(0,0)$ ,  $(0,1)$ , and  $(1,-1)$ . Determine the type of each point using linearization.

$$\frac{\partial f}{\partial x} = \begin{bmatrix} 1 + x_2 & x_1 \\ x_2 - 3x_1^2 & -1 + 2x_2 + x_1 \end{bmatrix}$$

$$\left. \frac{\partial f}{\partial x} \right|_{(0,0)} = \begin{bmatrix} 1 & 0 \\ 0 & -1 \end{bmatrix} \Rightarrow \lambda_{1,2} = 1, -1 \Rightarrow (0,0) \text{ is a saddle}$$

$$\left. \frac{\partial f}{\partial x} \right|_{(0,1)} = \begin{bmatrix} 2 & 0 \\ 1 & 1 \end{bmatrix} \Rightarrow \lambda_{1,2} = 2, 1 \Rightarrow (0,1) \text{ is unstable node}$$

$$\left. \frac{\partial f}{\partial x} \right|_{(1,-1)} = \begin{bmatrix} 0 & 1 \\ -4 & -2 \end{bmatrix} \Rightarrow \lambda_{1,2} = -1 \pm j\sqrt{3} \Rightarrow (1,-1) \text{ is a stable focus}$$

(3)

$$0 = (1 - x_1)x_1 - \frac{2x_1x_2}{1 + x_1}, \quad 0 = \left(2 - \frac{x_2}{1 + x_1}\right)x_2$$

## 《非线性系统（第三版）》习题解答

From the second equation,  $x_2 = 0$  or  $x_2 = 2(1 + x_1)$ .

$$x_2 = 0 \Rightarrow x_1 = 0 \text{ or } x_1 = 1$$

$$x_2 = 2(1 + x_1) \Rightarrow 0 = (x_1 + 3)x_1 \Rightarrow x_1 = 0 \text{ or } x_1 = -3$$

There are four equilibrium points at  $(0, 0)$ ,  $(1, 0)$ ,  $(0, 2)$ , and  $(-3, -4)$ . Notice that we have assumed  $1 + x_1 \neq 0$ ; otherwise the equation would not be well defined.

$$\frac{\partial f}{\partial x} = \begin{bmatrix} 1 - 2x_1 - \frac{2x_2}{(1+x_1)^2} & -2\frac{x_1}{(1+x_1)} \\ \frac{x_2^2}{(1+x_1)^2} & 2 - \frac{2x_2}{(1+x_1)} \end{bmatrix}$$

$$\frac{\partial f}{\partial x} \Big|_{x=(0,0)} = \begin{bmatrix} 1 & 0 \\ 0 & 2 \end{bmatrix}; \text{ Eigenvalues : } 1, 2 \Rightarrow (0, 0) \text{ is unstable node}$$

$$\frac{\partial f}{\partial x} \Big|_{x=(1,0)} = \begin{bmatrix} -1 & -1 \\ 0 & 2 \end{bmatrix}; \text{ Eigenvalues : } -1, 2 \Rightarrow (1, 0) \text{ is a saddle}$$

$$\frac{\partial f}{\partial x} \Big|_{x=(0,2)} = \begin{bmatrix} -3 & 0 \\ 4 & -2 \end{bmatrix}; \text{ Eigenvalues : } -3, -2 \Rightarrow (0, 2) \text{ is a stable node}$$

$$\frac{\partial f}{\partial x} \Big|_{x=(-3,-4)} = \begin{bmatrix} 9 & -3 \\ 4 & -2 \end{bmatrix}; \text{ Eigenvalues : } 7.722, -0.772 \Rightarrow (-3, -4) \text{ is a saddle}$$

(4)

$$0 = x_2, \quad 0 = -x_1 + x_2(1 - x_1^2 + 0.1x_1^4)$$

There is a unique equilibrium point at  $(0, 0)$ . Determine its type using linearization.

$$\frac{\partial f}{\partial x} = \begin{bmatrix} 0 & 1 \\ -1 - 2x_1x_2 + 0.4x_1^3x_2 & 1 - x_1^2 + 0.1x_1^4 \end{bmatrix}$$

$$\frac{\partial f}{\partial x} \Big|_{(0,0)} = \begin{bmatrix} 0 & 1 \\ -1 & 1 \end{bmatrix} \Rightarrow \lambda_{1,2} = (1/2) \pm j\sqrt{3}/2 \Rightarrow (0, 0) \text{ is unstable focus}$$

(5)

$$0 = (x_1 - x_2)(1 - x_1^2 - x_2^2), \quad 0 = (x_1 + x_2)(1 - x_1^2 - x_2^2)$$

$\{x_1^2 + x_2^2 = 1\}$  is an equilibrium set and  $(0, 0)$  is an isolated equilibrium point.

$$\frac{\partial f}{\partial x} \Big|_{x=(0,0)} = \begin{bmatrix} 1 - 3x_1^2 - x_2^2 + 2x_1x_2 & -2x_1x_2 - 1 + x_1^2 + 3x_2^2 \\ 1 - 3x_1^2 - x_2^2 - 2x_1x_2 & -2x_1x_2 + 1 - x_1^2 - 3x_2^2 \end{bmatrix} \Big|_{(0,0)} = \begin{bmatrix} 1 & -1 \\ 1 & 1 \end{bmatrix}$$

Eigenvalues are  $1 \pm j$ ; hence,  $(0, 0)$  is unstable focus.

(6)

$$0 = -x_1^3 + x_2, \quad 0 = x_1 - x_2^3$$

$$x_2 = x_1^3 \Rightarrow x_1(1 - x_1^6) = 0 \Rightarrow x_1 = 0 \text{ or } x_1^6 = 1$$

The equation  $x_1^6 = 1$  has two real roots at  $x_1 = \pm 1$ . Thus, there are three equilibrium points at  $(0, 0)$ ,  $(1, 1)$ ,  $(-1, -1)$ .

$$\frac{\partial f}{\partial x} = \begin{bmatrix} -3x_1^2 & 1 \\ 1 & -3x_2^2 \end{bmatrix}$$

## 《非线性系统（第三版）》习题解答

$$\left. \frac{\partial f}{\partial x} \right|_{x=(0,0)} = \begin{bmatrix} 0 & 1 \\ 1 & 0 \end{bmatrix}; \text{ Eigenvalues : } 1, -1 \Rightarrow (0,0) \text{ is a saddle}$$

$$\left. \frac{\partial f}{\partial x} \right|_{x=(1,1)} = \begin{bmatrix} -3 & 1 \\ 1 & -3 \end{bmatrix}; \text{ Eigenvalues : } -2, -4 \Rightarrow (1,1) \text{ is a stable node}$$

Similarly,  $(-1, -1)$  is a stable node.

• 2.2 (1)

$$0 = x_2, \quad 0 = -x_1 + (1/16)x_1^5 - x_2$$

$$x_2 = 0 \Rightarrow 0 = x_1(x_1^4 - 16) \Rightarrow x_1 = 0, 2, \text{ or } -2$$

There are three equilibrium points at  $(0,0)$ ,  $(2,0)$ , and  $(-2,0)$ . Determine the type of each point using linearization.

$$\frac{\partial f}{\partial x} = \begin{bmatrix} 0 & 1 \\ -1 + (5/16)x_1^4 & -1 \end{bmatrix}$$

$$\left. \frac{\partial f}{\partial x} \right|_{(0,0)} = \begin{bmatrix} 0 & 1 \\ -1 & -1 \end{bmatrix} \Rightarrow \lambda_{1,2} = -(1/2) \pm j\sqrt{3}/2 \Rightarrow (0,0) \text{ is a stable focus}$$

$$\left. \frac{\partial f}{\partial x} \right|_{(2,0)} = \begin{bmatrix} 0 & 1 \\ 4 & -1 \end{bmatrix} \Rightarrow \lambda_{1,2} = -(1/2) \pm \sqrt{17}/2 \Rightarrow (2,0) \text{ is a saddle}$$

Similarly,  $(-2,0)$  is a saddle.

(2)

$$0 = 2x_1 - x_1x_2, \quad 0 = 2x_1^2 - x_2$$

$$x_1(2 - x_2) = 0 \Rightarrow x_1 = 0 \text{ or } x_2 = 2$$

$$x_1 = 0 \Rightarrow x_2 = 0, \quad x_2 = 2 \Rightarrow x_1^2 = 1 \Rightarrow x_1 = 1 \text{ or } -1$$

There are three equilibrium points at  $(0,0)$ ,  $(1,2)$ , and  $(-1,2)$ . Determine the type of each point using linearization.

$$\frac{\partial f}{\partial x} = \begin{bmatrix} 2 - x_2 & -x_1 \\ 4x_1 & -1 \end{bmatrix}$$

$$\left. \frac{\partial f}{\partial x} \right|_{(0,0)} = \begin{bmatrix} 2 & 0 \\ 0 & -1 \end{bmatrix} \Rightarrow \lambda_{1,2} = 2, -1 \Rightarrow (0,0) \text{ is a saddle}$$

$$\left. \frac{\partial f}{\partial x} \right|_{(1,2)} = \begin{bmatrix} 0 & -1 \\ 4 & -1 \end{bmatrix} \Rightarrow \lambda_{1,2} = -(1/2) \pm j\sqrt{15}/2 \Rightarrow (1,2) \text{ is a stable focus}$$

$$\left. \frac{\partial f}{\partial x} \right|_{(-1,2)} = \begin{bmatrix} 0 & 1 \\ -4 & -1 \end{bmatrix} \Rightarrow \lambda_{1,2} = -(1/2) \pm j\sqrt{15}/2 \Rightarrow (-1,2) \text{ is a stable focus}$$

(3)

$$0 = x_2, \quad 0 = -x_2 - \psi(x_1 - x_2)$$

$$x_2 = 0 \Rightarrow \psi(x_1) = 0 \Rightarrow x_1 = 0$$

There is a unique equilibrium point at  $(0,0)$ . Determine its type by linearization.

$$\left. \frac{\partial f}{\partial x} \right|_{(0,0)} = \begin{bmatrix} 0 & 1 \\ -3(x_1 - x_2)^2 - 0.5 & -1 + 3(x_1 - x_2)^2 + 0.5 \end{bmatrix}_{(0,0)} = \begin{bmatrix} 0 & 1 \\ -0.5 & -0.5 \end{bmatrix}$$

The eigenvalues are  $-(1/4) \pm j\sqrt{7}/4$ . Hence,  $(0,0)$  is stable focus.

## 《非线性系统（第三版）》习题解答

• 2.3 (1) The system has three equilibrium points:  $(0,0)$  is a stable focus,  $(1,-1)$  and  $(-1,1)$  are saddle points. The phase portrait is shown in Figure 2.1. The stable trajectories of the saddle form a lobe around the stable focus. All trajectories inside the lobe converge to the stable focus. All trajectories outside it diverge to infinity.

(2) The system has three equilibrium points:  $(0,0)$  is a saddle,  $(0,1)$  is unstable node, and  $(1,-1)$  is a stable focus. The phase portrait is shown in Figure 2.2. The  $x_2$ -axis is a trajectory itself since  $x_1(t) \equiv 0 \Rightarrow \dot{x}_1(t) \equiv 0$ . The  $x_2$ -axis is a separatrix. All trajectories in the right half converge to the stable focus. All trajectories in the left half have diverge to infinity. On the  $x_2$ -axis itself, trajectories starting at  $x_2 < 1$  converge to the origin, while trajectories starting at  $x_2 > 1$  diverge to infinity.

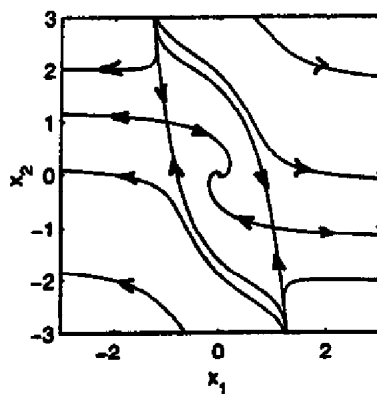

Figure 2.1: Exercise 2.3(1).

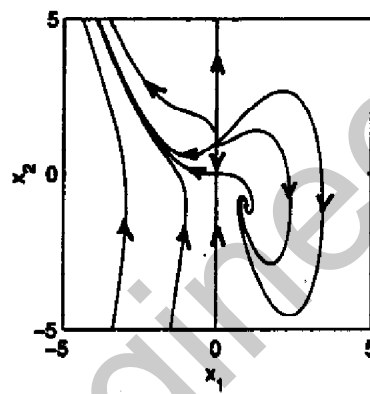

Figure 2.2: Exercise 2.3(2).

(3) The system has four equilibrium points:  $(0,0)$  is unstable node,  $(1,0)$  is a saddle,  $(0,2)$  is a stable node, and  $(-3,-4)$  is a saddle. To avoid the condition  $x_1 + 1 = 0$ , we limit our analysis to the right half of the plane, that is,  $\{x_1 \geq 0\}$ . This makes sense in view of the fact that the  $x_2$ -axis is a trajectory since  $x_1(t) \equiv 0 \Rightarrow \dot{x}_1(t) \equiv 0$ . Hence, trajectories starting in  $\{x_1 \geq 0\}$  stay there for all time. The phase portrait is shown in Figure 2.3. Notice that the  $x_1$ -axis is a trajectory since  $x_2(t) \equiv 0 \Rightarrow \dot{x}_2(t) \equiv 0$ . It is a separatrix that divides the half plane  $\{x_1 \geq 0\}$  into two quarters. All trajectories starting in the quarter  $\{x_1 > 0, x_2 > 0\}$  converge to the stable node  $(0,2)$ . All trajectories starting in the quarter  $\{x_1 > 0, x_2 < 0\}$  diverge to infinity. Trajectories starting on the  $x_2$ -axis approach the stable node  $(0,2)$  if  $x_2(0) > 0$  and diverge to infinity if  $x_2(0) < 0$ . Trajectories starting on the  $x_1$ -axis with  $x_1(0) > 0$  approach the saddle  $(1,0)$ .

(4) There is a unique equilibrium point at the origin, which is unstable focus. The phase portrait is shown in Figure 2.4. There are two limit cycles. The inner cycle is stable while the outer one is unstable. All trajectories starting inside the stable limit cycle, except the origin, approach it as  $t$  tends to infinity. Trajectories starting in the region between the two limit cycles approach the stable limit cycle. Trajectories starting outside the unstable limit cycle diverge to infinity.

(5) The system has an equilibrium set at the unit circle and unstable focus at the origin. The phase portrait is shown in Figure 2.5. All trajectories, except the origin, approach the unit circle as  $t$  tends to infinity.

(6) The system has three equilibrium points: a saddle at  $(0,0)$  and stable nodes at  $(1,1)$  and  $(-1,-1)$ . The phase portrait is shown in Figure 2.6. The stable trajectories of the saddle lie on the line  $x_1 + x_2 = 0$ . All trajectories to the right of this line converge to the stable node  $(1,1)$  and all trajectories to its left converge to the stable node  $(-1,-1)$ . Trajectories on the line  $x_1 + x_2 = 0$  itself converge to the origin.



《非线性系统（第三版）习题解答

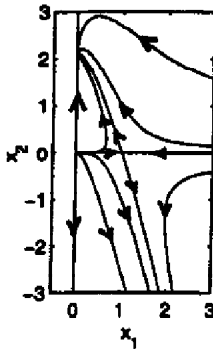

Figure 2.3: Exercise 2.3(3).

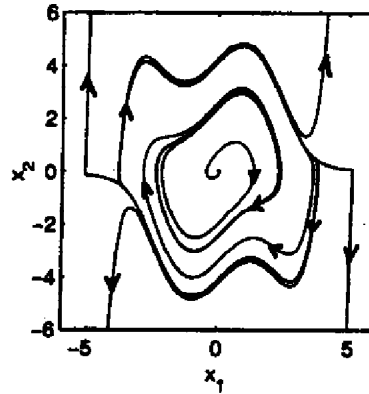

Figure 2.4: Exercise 2.3(4).

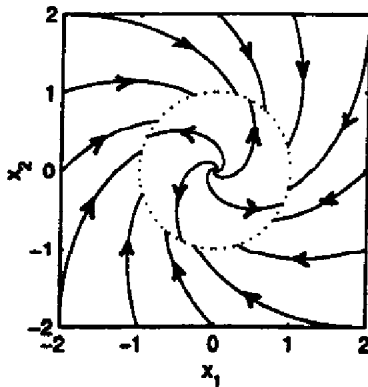

Figure 2.5: Exercise 2.3(5).

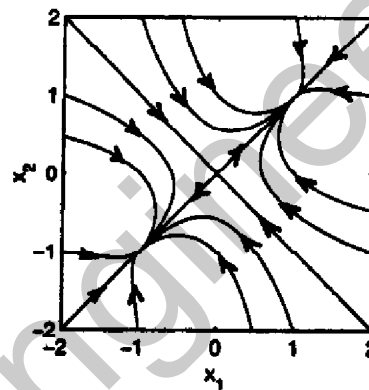

Figure 2.6: Exercise 2.3(6).

- 2.4 (1) The system has three equilibrium points at  $(0, 0)$ ,  $(a, 0)$ , and  $(-a, 0)$ , where  $a$  is the root of  $a = \tan(a/2) \Rightarrow a \approx 2.3311$

The Jacobian matrix is

$$\frac{\partial f}{\partial x} = \begin{bmatrix} 0 & 1 \\ 1 - 2/[1 + (x_1 + x_2)^2] & -2/[1 + (x_1 + x_2)^2] \end{bmatrix}$$

$$\frac{\partial f}{\partial x} \Big|_{(0,0)} = \begin{bmatrix} 0 & 1 \\ -1 & -2 \end{bmatrix} \Rightarrow \lambda_{1,2} = -1, -1$$

Although we have multiple eigenvalues, we can conclude that the origin is a stable node because  $f(x)$  is an analytic function of  $x$  in the neighborhood of the origin.

$$\frac{\partial f}{\partial x} \Big|_{(2.3311,0)} = \begin{bmatrix} 0 & 1 \\ 0.6892 & -0.3108 \end{bmatrix} \Rightarrow \lambda_{1,2} = 0.6892, -1 \Rightarrow (2.3311, 0) \text{ is a saddle}$$

Similarly,  $(-2.3311, 0)$  is a saddle. The phase portrait is shown in Figure 2.7 with the arrowheads. The stable trajectories of the two saddle points forms two separatrices, which divide the plane into three regions. All trajectories in the middle region converge to the origin as  $t$  tends to infinity. All trajectories in the outer

## 《非线性系统（第三版）》习题解答

regions diverge to infinity.

(2)

$$0 = x_1(2 - x_2), \quad 0 = 2x_1^2 - x_2$$

From the first equation,  $x_1 = 0$  or  $x_2 = 2$ .

$$x_1 = 0 \Rightarrow x_2 = 0$$

$$x_2 = 2 \Rightarrow x_1^2 = 1 \Rightarrow x_1 = \pm 1$$

There are three equilibrium points at  $(0, 0)$ ,  $(1, 2)$ , and  $(-1, 2)$ .

$$\left. \frac{\partial f}{\partial x} \right|_{(0,0)} = \begin{bmatrix} 2 & 0 \\ 0 & -1 \end{bmatrix} \Rightarrow \lambda_{1,2} = 2, -1 \Rightarrow (0, 0) \text{ is a saddle}$$

$$\left. \frac{\partial f}{\partial x} \right|_{(1,2)} = \begin{bmatrix} 0 & -1 \\ 4 & -1 \end{bmatrix} \Rightarrow \lambda_{1,2} = -(1/2) \pm j\sqrt{15}/2 \Rightarrow (1, 2) \text{ is a stable focus}$$

$$\left. \frac{\partial f}{\partial x} \right|_{(-1,2)} = \begin{bmatrix} 0 & 1 \\ -4 & -1 \end{bmatrix} \Rightarrow \lambda_{1,2} = -(1/2) \pm j\sqrt{15}/2 \Rightarrow (-1, 2) \text{ is a stable focus}$$

The phase portrait is shown in Figure 2.7 with the arrowheads. The stable trajectories of the saddle lie on the  $x_2$ -axis. They form a separatrix that divides the plane in two halves. Trajectories in the right half converge to the stable focus  $(1, 2)$  and those in the half converge to the stable focus  $(-1, 2)$ .

(3) There is a unique equilibrium point at the origin.

$$\left. \frac{\partial f}{\partial x} \right|_{(0,0)} = \begin{bmatrix} 0 & 1 \\ -1 & 1 \end{bmatrix} \Rightarrow \lambda_{1,2} = (1/2) \pm j\sqrt{3}/2 \Rightarrow (0, 0) \text{ is an unstable focus}$$

The phase portrait is shown in Figure 2.7 with the arrowheads. There is a stable limit cycle around the origin. All trajectories, except the origin, approach the limit cycle as  $t$  tends to infinity.

(4) The equilibrium points are given by the real roots of the equation

$$0 = y^4 - 2y^2 + y$$

where  $x_1 = y^2$  and  $x_2 = 1 - y$ . It can be seen that the equation has four roots at  $y = 0, 1, (-1 \pm \sqrt{5})/2$ . Hence, there are four equilibrium points at  $(0, 1)$ ,  $(1, 0)$ ,  $((3 - \sqrt{5})/2, (3 - \sqrt{5})/2)$ , and  $((3 + \sqrt{5})/2, (3 + \sqrt{5})/2)$ . The following table shows the Jacobian matrix and the type of each point.

Point	Jacobian matrix	Eigenvalues	Type
$(0, 1)$	$\begin{bmatrix} -2 & -1 \\ -1 & 0 \end{bmatrix}$	$-2.4142, 0.4142$	saddle
$(1, 0)$	$\begin{bmatrix} 0 & -1 \\ -1 & -2 \end{bmatrix}$	$0.4142, -2.4142$	saddle
$((3 - \sqrt{5})/2, (3 - \sqrt{5})/2)$	$\begin{bmatrix} -1.2361 & -1 \\ -1 & -1.2361 \end{bmatrix}$	$-0.2361, -2.2361$	stable node
$((3 + \sqrt{5})/2, (3 + \sqrt{5})/2)$	$\begin{bmatrix} 3.2361 & -1 \\ -1 & 3.2361 \end{bmatrix}$	$4.2361, 2.2361$	unstable node

## 《非线性系统（第三版）》习题解答

The phase portrait is shown in Figure 2.7 with the arrowheads. The stable trajectories of the saddle points divide the plane into two regions. The region that contains the stable focus has the feature that all trajectories inside it converge to the stable focus. All trajectories in the other region diverge to infinity.

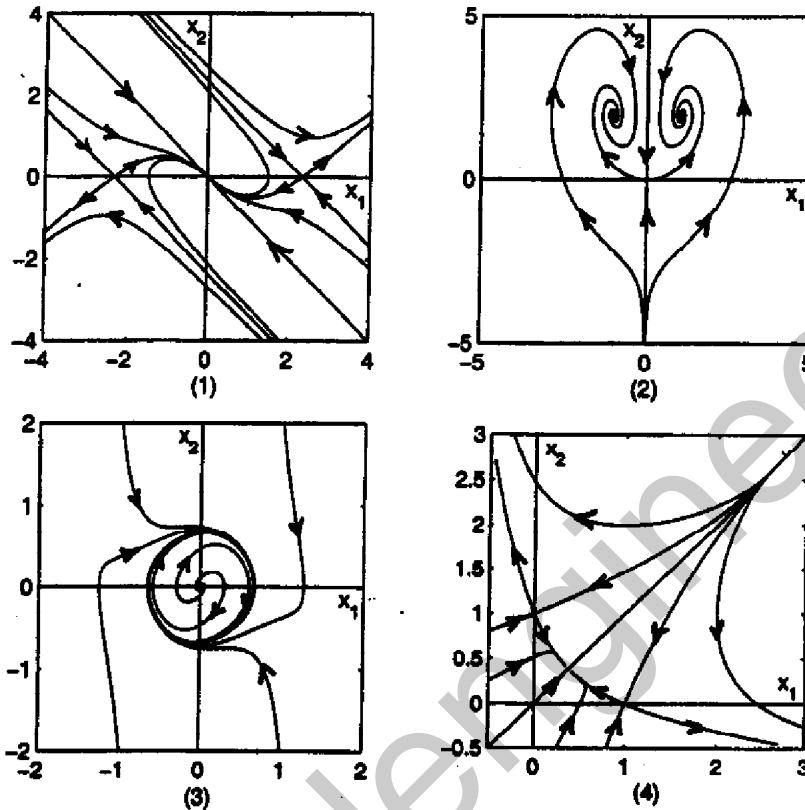

Figure 2.7: Phase portraits of Exercise 2.4.

• 2.5 (a)

$$\frac{\partial f}{\partial x} = \begin{bmatrix} -1 + x_1 x_2 \alpha(x) & -\beta(x) + x_2^2 \alpha(x) \\ \beta(x) - x_1^2 \alpha(x) & -1 - x_1 x_2 \alpha(x) \end{bmatrix}$$

where

$$\alpha(x) = \frac{1}{(x_1^2 + x_2^2)(\ln \sqrt{x_1^2 + x_2^2})^2}, \quad \beta(x) = \frac{1}{\ln \sqrt{x_1^2 + x_2^2}}$$

Noting that  $\lim_{x \rightarrow 0} x_i x_j \alpha(x) = 0$  for  $i, j = 1, 2$  and  $\lim_{x \rightarrow 0} \beta(x) = 0$ , it can be seen that

$$\left. \frac{\partial f}{\partial x} \right|_{x=0} = \begin{bmatrix} -1 & 0 \\ 0 & -1 \end{bmatrix} \Rightarrow \text{the origin is a stable node}$$

(b) Transform the state equation into the polar coordinates

$$r = \sqrt{x_1^2 + x_2^2}, \quad \theta = \tan^{-1} \left( \frac{x_2}{x_1} \right)$$

to obtain

$$\dot{r} = -r \Rightarrow r(t) = r_0 e^{-t}$$

## 《非线性系统（第三版）》习题解答

and, for  $0 < r_0 < 1$ ,

$$\dot{\theta} = \frac{1}{\ln r} = \frac{1}{\ln r_0 - t} \Rightarrow \theta(t) = \theta_0 - \ln(|\ln r_0| + t) + \ln(|\ln r_0|)$$

Hence, for  $0 < r_0 < 1$ ,  $r(t)$  and  $\theta(t)$  are strictly decreasing and  $\lim_{t \rightarrow \infty} r(t) = 0$ ,  $\lim_{t \rightarrow \infty} \theta(t) = -\infty$ . Thus, the trajectory spirals clockwise toward the origin.

(c)  $f(x)$  is continuously differentiable, but not analytic, in the neighborhood of  $x = 0$ . See the discussion on page 54 of the text.

• 2.6 (a) The equilibrium points are the real roots of

$$0 = -x_1 + ax_2 - bx_1x_2 + x_2^2, \quad 0 = -(a+b)x_1 + bx_1^2 - x_1x_2$$

From the second equation we have

$$x_1[-(a+b) + bx_1 - x_2] = 0 \Rightarrow x_1 = 0 \text{ or } x_2 = -(a+b) + bx_1$$

Substitution of  $x_1 = 0$  in the first equation yields

$$x_2(x_2 + a) = 0 \Rightarrow x_2 = 0 \text{ or } x_2 = -a$$

Thus, there are equilibrium points at  $(0, 0)$  and  $(0, -a)$ . Substitution of  $x_2 = -(a+b) + bx_1$  in the first equation yields

$$0 = b(a+b) - (1+b^2)x_1 = 0 \Rightarrow x_1 = \frac{b(a+b)}{1+b^2} \Rightarrow x_2 = \frac{-(a+b)}{1+b^2}$$

Hence, there is an equilibrium point at  $\left(\frac{b(a+b)}{1+b^2}, \frac{-(a+b)}{1+b^2}\right)$ .

(b)

$$\frac{\partial f}{\partial x} = \begin{bmatrix} -1 - bx_2 & a - bx_1 + 2x_2 \\ -(a+b) + 2bx_1 - x_2 & -x_1 \end{bmatrix}$$

1.  $x = (0, 0)$

$$A = \begin{bmatrix} -1 & a \\ -(a+b) & 0 \end{bmatrix}$$

The eigenvalues of  $A$  are

$$\lambda = \frac{-1 \pm \sqrt{1 - 4a(a+b)}}{2}$$

The equilibrium point  $(0, 0)$  is a stable focus if  $4a(a+b) > 1$ , a stable node if  $0 < 4a(a+b) < 1$ , and a saddle if  $a(a+b) < 0$ .

2.  $x = (0, -a)$

$$A = \begin{bmatrix} -1 + ab & -a \\ -b & 0 \end{bmatrix}$$

The eigenvalues of  $A$  are  $\lambda = ab$  and  $\lambda = -1$ . The equilibrium point  $(0, -a)$  is a saddle if  $b > 0$  and a stable node if  $b < 0$ .

3.  $x = \left(\frac{b(a+b)}{1+b^2}, \frac{-(a+b)}{1+b^2}\right)$

$$A = \frac{1}{1+b^2} \begin{bmatrix} -1 + ab & -b^3 - a - 2b \\ (a+b)b^2 & -b(a+b) \end{bmatrix}$$

## 《非线性系统（第三版）》习题解答

The eigenvalues of  $A$  are

$$\lambda = \frac{-1 \pm \sqrt{1 - 4b(a+b)}}{2}$$

The equilibrium point  $\left(\frac{b(a+b)}{1+b^2}, \frac{-(a+b)}{1+b^2}\right)$  is a stable focus if  $4b(a+b) > 1$ , a stable node if  $0 < 4b(a+b) < 1$ , and a saddle if  $b(a+b) < 0$ .

The various cases are summarized in the following table.

	$(0, 0)$	$(0, -a)$	$\left(\frac{b(a+b)}{1+b^2}, \frac{-(a+b)}{1+b^2}\right)$
$b > 0, 4a(a+b) > 1, 4b(a+b) > 1$	stable focus	saddle	stable focus
$b > 0, 4a(a+b) > 1, 4b(a+b) < 1$	stable focus	saddle	stable node
$b > 0, 4a(a+b) < 1, 4b(a+b) > 1$	stable node	saddle	stable focus
$b > 0, 4a(a+b) < 1, 4b(a+b) < 1$	stable node	saddle	stable node
$b < 0, a+b > 0, 4a(a+b) > 1$	stable focus	stable node	saddle
$b < 0, a+b > 0, 4a(a+b) < 1$	stable node	stable node	saddle
$b < 0, a+b < 0, 4b(a+b) > 1$	saddle	stable node	stable focus
$b < 0, a+b < 0, 4a(a+b) < 1$	saddle	stable node	stable node

If any one of the above conditions holds with equality rather than inequality, we end up with multiple eigenvalues or eigenvalues with zero real parts, in which case linearization fails to determine the type of the equilibrium point of the nonlinear system.

(c) The phase portraits of the three cases are shown in Figures 2.8 through 2.10.

i  $a = b = 1$ . The equilibrium points are

$(0, 0)$	stable focus
$(0, -1)$	saddle
$(1, -1)$	stable focus

The linearization at the saddle is  $A = \begin{bmatrix} 0 & -1 \\ -1 & 0 \end{bmatrix}$ . The stable eigenvector is  $\begin{bmatrix} 1 \\ 1 \end{bmatrix}$  and the unstable eigenvector is  $\begin{bmatrix} -1 \\ 1 \end{bmatrix}$ . They are used to generate the stable and unstable trajectories of the saddle.

The stable trajectories form a separatrix that divides the plane into two halves, with all trajectories in the right half approaching  $(1, -1)$  and all trajectories in the left half approaching  $(0, 0)$ .

ii  $a = 1, b = -\frac{1}{2}$ . The equilibrium points are

$(0, 0)$	stable focus
$(0, -1)$	stable node
$\left(\frac{-1}{5}, \frac{-2}{5}\right)$	saddle

The linearization at the saddle is  $A$ , where  $(1+b^2)A = \begin{bmatrix} -(3/2) & (1/8) \\ (1/8) & (1/4) \end{bmatrix}$ . The stable eigenvector is  $\begin{bmatrix} 0.9975 \\ -0.0709 \end{bmatrix}$  and the unstable eigenvector is  $\begin{bmatrix} 0.0709 \\ 0.9975 \end{bmatrix}$ . They are used to generate the stable and unstable trajectories of the saddle. The stable trajectories form a separatrix in the form of a lobe. All trajectories outside the lobe approach  $(0, -1)$ ; all trajectories inside the lobe approach  $(0, 0)$ .

iii  $a = 1, b = -2$ . The equilibrium points are

$(0, 0)$	saddle
$(0, -1)$	stable node
$\left(\frac{2}{5}, \frac{1}{5}\right)$	stable focus

The linearization at the saddle is  $A = \begin{bmatrix} -1 & 1 \\ 1 & 0 \end{bmatrix}$ . The stable eigenvector is  $\begin{bmatrix} 0.8507 \\ -0.5257 \end{bmatrix}$  and the

## 《非线性系统（第三版）》习题解答

unstable eigenvector is  $\begin{bmatrix} 0.5257 \\ 0.8507 \end{bmatrix}$ . They are used to generate the stable and unstable trajectories of the saddle. The stable trajectories form a separatrix in the form of a lobe. All trajectories outside the lobe approach  $(0, -1)$ ; all trajectories inside the lobe approach  $(\frac{2}{5}, \frac{1}{5})$ .

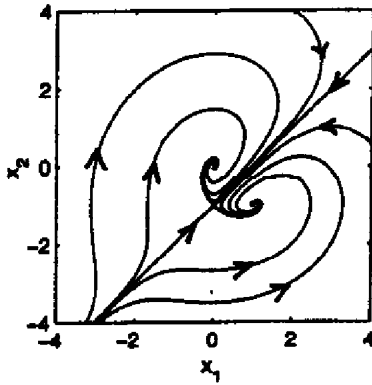

Figure 2.8: Exercise 2.6(i).

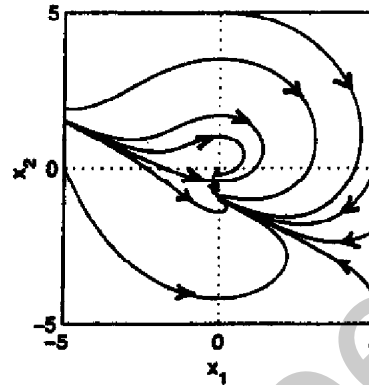

Figure 2.9: Exercise 2.6(ii).

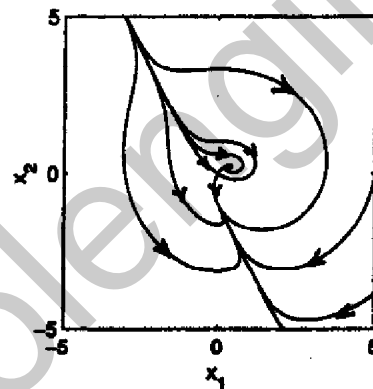

Figure 2.10: Exercise 2.6(iii).

• 2.7 The system

$$\dot{x}_1 = x_2, \quad \dot{x}_2 = -x_1 - x_2 \left( -1 + 3x_1^2 - x_1^4 + \frac{1}{18}x_1^6 \right)$$

has a unique equilibrium point at the origin. Linearization at the origin yields  $A = \begin{bmatrix} 0 & 1 \\ -1 & 1 \end{bmatrix}$  whose eigenvalues are  $0.5 \pm 0.866j$ . Hence the origin is unstable focus. The phase portrait is shown in Figure 2.11. There are three limit cycles. The inner limit cycle is stable, the middle one is unstable, and the outer one is stable. All trajectories starting inside the middle limit cycle, other than the origin, approach the inner limit cycle as  $t$  tends to infinity. All trajectories starting outside the middle limit cycle approach the outer limit cycle as  $t$  tends to infinity. Trajectories starting at the unstable focus or on the unstable limit cycle remain there.

• 2.8 (a) The equilibrium points are the real roots of

$$0 = x_2, \quad 0 = -x_1 + \frac{1}{18}x_1^5 - x_2$$

《非线性系统（第三版）》习题解答

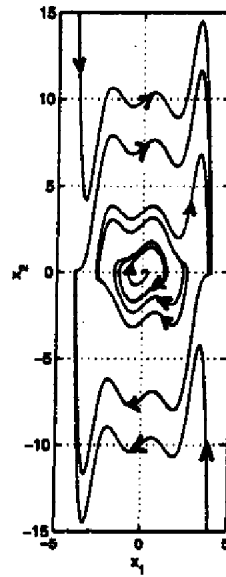

Figure 2.11: Exercise 2.7.

Hence

$$x_1(16 - x_1^4) = 0 \Rightarrow x_1 = 0, \pm 2$$

There are three equilibrium points at  $(0, 0)$ ,  $(2, 0)$ , and  $(-2, 0)$ .

$$\frac{\partial f}{\partial x} = \begin{bmatrix} 0 & 1 \\ -1 + \frac{5}{16}x_1^4 & -1 \end{bmatrix}$$

$$x = (0, 0) \Rightarrow A = \begin{bmatrix} 0 & 1 \\ -1 & -1 \end{bmatrix} \Rightarrow \lambda = \frac{-1 \pm j\sqrt{3}}{2}$$

$(0, 0)$  is a stable focus.

$$x = (2, 0) \text{ or } (-2, 0) \Rightarrow A = \begin{bmatrix} 0 & 1 \\ 4 & -1 \end{bmatrix} \Rightarrow \lambda = \frac{-1 \pm \sqrt{17}}{2}$$

$(2, 0)$  and  $(-2, 0)$  are saddle points.

(b) The phase portrait can be sketched by constructing a vector field diagram and using the information about the equilibrium points, especially the directions of the stable and unstable trajectories at the saddle points. The stable and unstable eigenvectors of the linearization at the saddle points are

$$v_{stable} = \begin{bmatrix} 1 \\ \frac{-1 - \sqrt{17}}{2} \end{bmatrix} = \begin{bmatrix} 1 \\ -2.5616 \end{bmatrix}, \quad v_{unstable} = \begin{bmatrix} 1 \\ \frac{-1 + \sqrt{17}}{2} \end{bmatrix} = \begin{bmatrix} 1 \\ 1.5616 \end{bmatrix}$$

Find the directions of the vector fields on the two axes. On  $x_1 = 0$ ,  $f = \begin{bmatrix} x_2 \\ -x_2 \end{bmatrix}$ . Hence the vector field makes an angle  $-45$  deg with the  $x_1$  axis and its magnitude increases with  $|x_2|$ . On  $x_2 = 0$ ,  $f =$

## 《非线性系统（第三版）》习题解答

$\begin{bmatrix} 0 \\ -x_1 + \frac{x_1^4}{16} \end{bmatrix}$ . Hence the vector field is parallel to the  $x_2$ -axis. The sketch can be improved by finding the vector field at other points.

• 2.9 (a)

$$\dot{x}_1 = v_d - x_2, \quad \dot{x}_2 = \frac{1}{m} [K_f x_1 + K_p(v_d - x_2) - K_c \operatorname{sgn}(x_2) - K_f x_2 - K_a x_2^2]$$

(b) At the equilibrium points, we have

$$0 = v_d - x_2, \quad 0 = K_f x_1 + K_p(v_d - x_2) - K_c \operatorname{sgn}(x_2) - K_f x_2 - K_a x_2^2$$

From the first equation,  $x_2 = v_d$ , and from the second one,  $x_1 = (K_c + K_f v_d + K_a v_d^2)/K_f$ . This is the only equilibrium point. Linearization at the equilibrium point yields

$$A = \begin{bmatrix} 0 & -1 \\ K_f/m & -(K_f + 2K_a v_d + K_p)/m \end{bmatrix}$$

whose eigenvalues are

$$\lambda = \frac{-(K_f + 2K_a v_d + K_p)/m \pm \sqrt{(K_f + 2K_a v_d + K_p)^2/m^2 - 4K_f/m}}{2}$$

If  $(K_f + 2K_a v_d + K_p)^2 > 4mK_f$ , the equilibrium is a stable node, and if  $(K_f + 2K_a v_d + K_p)^2 < 4mK_f$ , the equilibrium is a stable focus.

(c) For the given numerical values, the eigenvalues of the linearization are  $-0.0289$  and  $-0.3461$ . Hence, the equilibrium point is a stable node. The phase portrait is shown in Figure 2.12. All trajectories approach the stable node along the slow eigenvector of the node, which has a small slope. Starting from different initial speeds, the trajectory reaches the desired speed with no (or very little) overshoot.

(d) The eigenvalues of the linearization are  $-0.1875 \pm 0.2546j$ ; hence the equilibrium point is a stable focus. The phase portrait is shown in Figure 2.13. All trajectories approach the stable focus. Notice the increased overshoot compared with the previous case. For example, starting at the initial state  $(x_1 = 15, x_2 = 10)$ , the speed reaches about  $36 \text{ m/sec}$  before approaching the steady-state of  $30 \text{ m/sec}$ .

(e) The phase portrait is shown in Figure 2.14. The local behavior near the equilibrium point is not affected since saturation will not be effective. However, far from the equilibrium point we can see that the state of the integrator,  $x_1$ , takes large values during saturation, resulting in an increased overshoot.

• 2.10 (a) Using the same scaling as in Example 2.1, the state equation is given by

$$\dot{x}_1 = 0.5[-h(x_1) + x_2], \quad \dot{x}_2 = 0.2(-x_1 - 0.2x_2 + 0.2)$$

where  $h(x_1)$  is given in Example 2.1. The equilibrium points are the intersection points of the curves  $x_2 = h(x_1)$  and  $x_2 = 1 - 5x_1$ . Figure 2.15 shows that there is a unique equilibrium point. Using the “roots” command of MATLAB, the equilibrium point was determined to be  $\bar{x} = (0.057, 0.7151)$ .

$$\frac{\partial f}{\partial x} = \begin{bmatrix} -0.5h'(x_1) & 0.5 \\ -0.2 & -0.04 \end{bmatrix}$$

$$\left. \frac{\partial f}{\partial x} \right|_{x=\bar{x}} = \begin{bmatrix} -1.0461 & 0.5 \\ -0.2 & -0.04 \end{bmatrix} \Rightarrow \text{Eigenvalues} = -0.9343, -0.1518 \Rightarrow \text{stable node}$$

(b) The phase portrait is shown in Figure 2.16. All trajectories approach the stable node. This circuit is known as “monostable” because it has one steady-state operating point.



《非线性系统（第三版）》习题解答

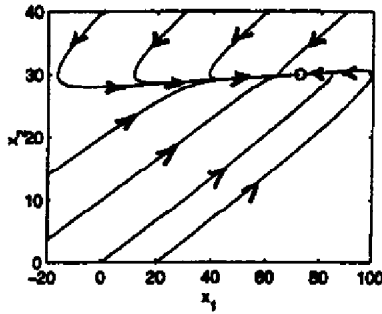

Figure 2.12: Exercise 2.9(c).

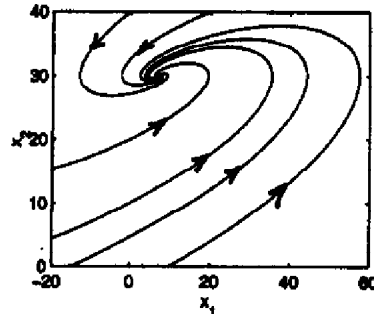

Figure 2.13: Exercise 2.9(d).

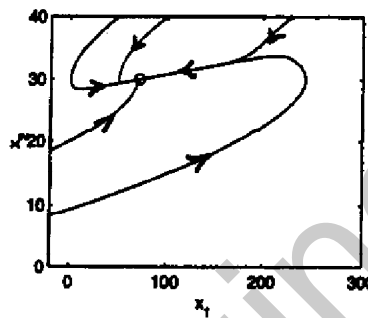

Figure 2.14: Exercise 2.9(e).

• 2.11 (a) Using the same scaling as in Example 2.1, the state equation is given by

$$\dot{x}_1 = 0.5[-h(x_1) + x_2], \quad \dot{x}_2 = 0.2(-x_1 - 0.2x_2 + 0.4)$$

where  $h(x_1)$  is given in Example 2.1. The equilibrium points are the intersection points of the curves  $x_2 = h(x_1)$  and  $x_2 = 2 - 5x_1$ . Figure 2.17 shows that there is a unique equilibrium point. Using the “roots” command of MATLAB, the equilibrium point was determined to be  $\bar{x} = (0.2582, 0.7091)$ .

$$\left. \frac{\partial f}{\partial x} \right|_{x=\bar{x}} = \begin{bmatrix} 1.8173 & 0.5 \\ -0.2 & -0.04 \end{bmatrix} \Rightarrow \text{Eigenvalues} = 1.7618, 0.0155 \Rightarrow \text{unstable node}$$

(b) The phase portrait is shown in Figure 2.18. The circuit has a stable limit cycle. All trajectories, except the constant solution at the equilibrium point, approach the limit cycle. This circuit is known as “astable.”

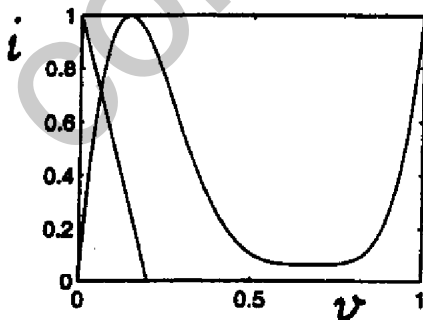

Figure 2.15: Exercise 2.10: equilibrium point.

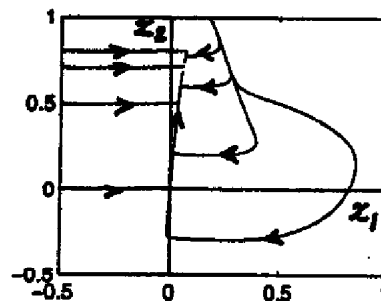

Figure 2.16: Exercise 2.10: phase portrait.

## 《非线性系统（第三版）》习题解答

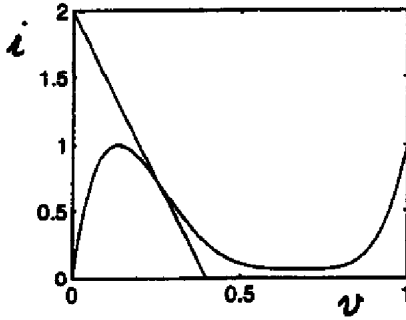

Figure 2.17: Exercise 2.11: equilibrium point.

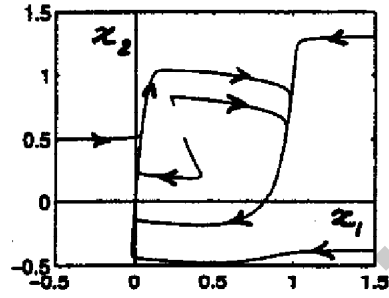

Figure 2.18: Exercise 2.11: phase portrait.

• 2.12 (a) Note that  $T_{12} = T_{21} = 1 \Rightarrow \frac{1}{R_{12}} = \frac{1}{R_{21}} = 1$  and  $T_{11} = T_{22} = 0 \Rightarrow \frac{1}{R_{11}} = \frac{1}{R_{22}} = 0$ . Hence the state equation is given by

$$\dot{x}_1 = h(x_1)[x_2 - 2\eta(x_1)] \stackrel{\text{def}}{=} f_1(x), \quad \dot{x}_2 = h(x_2)[x_1 - 2\eta(x_2)] \stackrel{\text{def}}{=} f_2(x)$$

where  $h(x) = \lambda \cos^2(\pi x/2)$  and  $\eta(x) = g^{-1}(x) = (2/\pi\lambda) \tan(\pi x/2)$ . Equilibrium points are the intersection points of the curves  $x_2 = 2\eta(x_1)$  and  $x_1 = 2\eta(x_2)$ . Note that  $\eta'(0) = 1/\lambda$  and  $\eta'(x) = (1/\lambda) \sec^2(\pi x/2) \geq 1/\lambda$ . Therefore, for  $\lambda \leq 2$ , the two curves intersect only at the origin  $(0, 0)$ . For  $\lambda > 2$ , there are three intersection points at  $(0, 0)$ ,  $(a, a)$  and  $(-a, -a)$  where  $0 < a < 1$  depends on  $\lambda$ . This fact can be seen by sketching the curves and using symmetry; see Figure 2.19. The partial derivatives of  $f_1$  and  $f_2$  are given by

$$\frac{\partial f_1}{\partial x_1} = h'(x_1)[x_2 - 2\eta(x_1)] - 2h(x_1)\eta'(x_1), \quad \frac{\partial f_1}{\partial x_2} = h(x_1)$$

$$\frac{\partial f_2}{\partial x_1} = h(x_2), \quad \frac{\partial f_2}{\partial x_2} = h'(x_2)[x_1 - 2\eta(x_2)] - 2h(x_2)\eta'(x_2)$$

At equilibrium points,  $[x_2 - 2\eta(x_1)] = 0$  and  $[x_1 - 2\eta(x_2)] = 0$ . Therefore, the Jacobian matrix reduces to

$$\left. \frac{\partial f}{\partial x} \right|_{x=(b,b)} = h(b) \begin{bmatrix} -2\eta'(b) & 1 \\ 1 & -2\eta'(b) \end{bmatrix}$$

where  $b = 0, a$ , or  $-a$ , depending on the equilibrium point.

$$\left. \frac{\partial f}{\partial x} \right|_{x=(0,0)} = \begin{bmatrix} -2 & \lambda \\ \lambda & -2 \end{bmatrix} \Rightarrow \text{Eigenvalues} = -2 \pm \lambda$$

For  $\lambda < 2$ , the unique equilibrium point at  $(0, 0)$  is a stable node. For  $\lambda > 2$ , the equilibrium point  $(0, 0)$  is a saddle. For  $\lambda > 2$  there are two other equilibrium points at  $(a, a)$  and  $(-a, -a)$ .

$$\left. \frac{\partial f}{\partial x} \right|_{x=(a,a)} = h(a) \begin{bmatrix} -2\eta'(a) & 1 \\ 1 & -2\eta'(a) \end{bmatrix} \Rightarrow \text{Eigenvalues} = h(a)[-2\eta'(a) \pm 1]$$

It is not hard to see from the sketch of the curves  $x_2 = 2\eta(x_1)$  and  $x_1 = 2\eta(x_2)$  that at the intersection point  $(a, a)$ , the slope  $2\eta'(a) > 1$ . Hence,  $(a, a)$  is a stable node. Similarly, it can be shown that  $(-a, -a)$  is a stable node.

(b) The phase portrait is shown in Figure 2.20. The stable trajectories of the saddle point at the origin form a separatrix that divides the plane into two regions. Trajectories in each region approach the stable node in that region.

## 《非线性系统（第三版）》习题解答

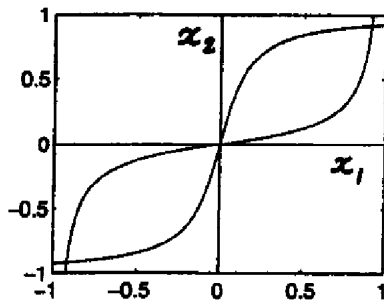

Figure 2.19: Exercise 2.12: equilibrium point.

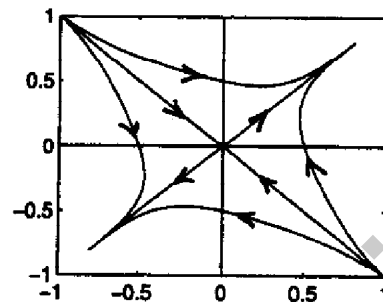

Figure 2.20: Exercise 2.12: phase portrait.

- 2.13 (a) Using Kirchhoff's Voltage law, we obtain

$$\dot{x}_1 = \frac{1}{C_1 R_1} [v_2 - v_1 - g(v_2)]$$

Using Kirchhoff's Current law, we obtain

$$\dot{x}_2 = \frac{1}{C_2} \left\{ -\frac{v_2}{R_2} - \frac{1}{R_1} [v_2 - v_1 - g(v_2)] \right\}$$

Thus, the state equation is

$$\begin{aligned} \dot{x}_1 &= \frac{1}{C_1 R_1} [-x_1 + x_2 - g(x_2)] \\ \dot{x}_2 &= \frac{1}{C_2 R_1} x_1 - \frac{1}{C_2 R_2} x_2 - \frac{1}{C_2 R_1} x_2 + \frac{1}{C_2 R_1} g(x_2) \end{aligned}$$

- (b) For the given data, the state equation is given by

$$\begin{aligned} \dot{x}_1 &= -x_1 + x_2 - g(x_2), & \dot{x}_2 &= x_1 - 2x_2 + g(x_2) \\ g(x_2) &= 3.234x_2 - 2.195x_2^3 + 0.666x_2^5 \end{aligned}$$

The system has a unique equilibrium point at the origin. The Jacobian at the origin is given by

$$\left. \frac{\partial f}{\partial x} \right|_{x_1=0; x_2=0} = \begin{bmatrix} -1 & -2.234 \\ 1 & 1.234 \end{bmatrix} \Rightarrow \text{Eigenvalues} = 0.117 \pm 0.993j$$

Hence the origin is an unstable focus. The phase portrait is shown in Figures 2.21 and 2.22 using two different scales. The system has two limit cycles. The inner limit cycle is stable, while the outer one is unstable. All trajectories starting inside the outer limit cycle, except the origin, approach the inner one. All trajectories starting outside the outer limit cycle diverge to infinity.

- 2.14 The system is given by

$$\begin{aligned} \dot{x}_1 &= x_2 \\ \dot{x}_2 &= -kx_1 - cx_2 - \eta(x_1, x_2) \end{aligned}$$

where

$$\eta(x_1, x_2) = \begin{cases} \mu_k mg \operatorname{sign}(x_2), & \text{for } |x_2| > 0 \\ -kx_1, & \text{for } x_2 = 0 \text{ \& } |x_1| \leq \mu_s mg/k \\ -\mu_s mg \operatorname{sign}(x_1), & \text{for } x_2 = 0 \text{ \& } |x_1| > \mu_s mg/k \end{cases}$$

## 《非线性系统（第三版）》习题解答

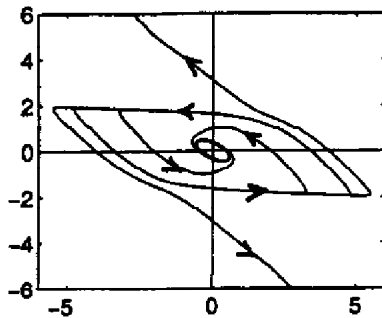

Figure 2.21: Exercise 2.13.

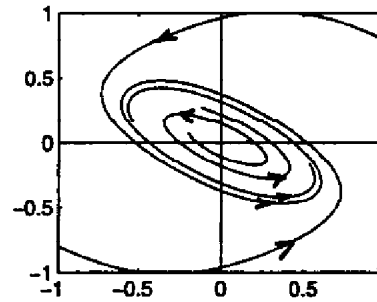

Figure 2.22: Exercise 2.13.

For  $x_2 > 0$ , the state equation is given by

$$\begin{aligned}\dot{x}_1 &= x_2 \\ \dot{x}_2 &= -kx_1 - cx_2 - \mu_k mg\end{aligned}$$

while, for  $x_2 < 0$ , it is given by

$$\begin{aligned}\dot{x}_1 &= x_2 \\ \dot{x}_2 &= -kx_1 - cx_2 + \mu_k mg\end{aligned}$$

In each half, we can determine the trajectories by studying the respective linear equation. Let us start with  $x_2 > 0$ . The linear state equation has an equilibrium point at  $(-\mu_k mg/k, 0)$ . Shifting the equilibrium to the origin, we obtain a linear state equation with the matrix  $\begin{bmatrix} 0 & 1 \\ -k & -c \end{bmatrix}$ , whose characteristic equation is  $\lambda^2 + c\lambda + k = 0$ , where  $k$  and  $c$  are positive constants. The equilibrium point is a stable focus when  $4k > c^2$  and a stable node when  $4k \leq c^2$ . We shall continue our discussion assuming  $4k > c^2$ . Trajectories would tend to spiral toward the equilibrium point  $(-\mu_k mg/k, 0)$ . It will not actually spiral toward the point because the equation is valid only for  $x_2 > 0$ . Thus, for any point in the upper half, we can solve the linear equation to find the trajectory that should spiral toward the equilibrium point, but follow the trajectory only until it hits the  $x_1$ -axis. For  $x_2 < 0$ , we have a similar situation except that trajectories tend to spiral toward the point  $(\mu_k mg/k, 0)$ . On the  $x_1$ -axis itself, we should distinguish between two regions. If a trajectory hits the  $x_1$ -axis within the interval  $[-\mu_s mg/k, \mu_s mg/k]$ , it will rest at equilibrium. If it hits outside this interval, it will have  $\dot{x}_2 \neq 0$  and will continue motion. Notice that trajectories reaching the  $x_1$ -axis in the interval  $x_1 > \mu_s mg/k$  will be coming from the upper half of the plane and will continue their motion into the lower half. By symmetry, trajectories reaching the  $x_1$ -axis in the interval  $x_1 < -\mu_s mg/k$  will be coming from the lower half of the plane and will continue their motion into the upper half. Thus, a trajectory starting far from the origin, will spiral toward the origin, until it hits the  $x_1$ -axis within the interval  $[-\mu_s mg/k, \mu_s mg/k]$ . The phase portrait is sketched in Figure 2.23.

### • 2.15 The solution of the state equation

$$\begin{aligned}\dot{x}_1 &= x_2, & x_1(0) &= x_{10} \\ \dot{x}_2 &= k, & x_2(0) &= x_{20}\end{aligned}$$

where  $k = \pm 1$ , is given by

$$\begin{aligned}x_2(t) &= kt + x_{20} \\ x_1(t) &= \frac{1}{2}kt^2 + x_{20}t + x_{10}\end{aligned}$$

## 《非线性系统（第三版）》习题解答

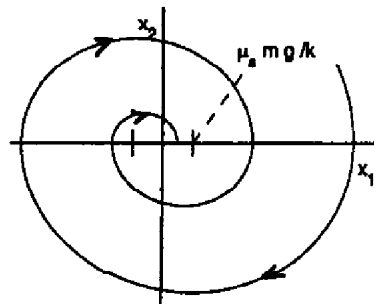

Figure 2.23: Exercise 2.14.

Eliminating  $t$  between the two equations, we obtain

$$x_1 = \frac{1}{2k}x_2^2 + c$$

where  $c = x_{10} - x_{20}^2/(2k)$ . This is the equation of the trajectories in the  $x_1$ - $x_2$  plane. Different trajectories correspond to different values of  $c$ . Figures 2.24 and 2.25 show the phase portraits for  $u = 1$  and  $u = -1$ , respectively. The two portraits are superimposed in Figure 2.26. From Figure 2.26 we see that trajectories can reach the origin through only two curves, which are highlighted. The curve in the lower half corresponds to  $u = 1$  and the curve in the upper half corresponds to  $u = -1$ . We will refer to these curves as the switching curves. To move any point in the plane to the origin, we can switch between  $\pm 1$ . For example, to move the point  $A$  to the origin, we apply  $u = -1$  until the trajectory hits the switching curve, then we switch to  $u = 1$ . Similarly, to move the point  $B$  to the origin, we apply  $u = 1$  until the trajectory hits the switching curve, then we switch to  $u = -1$ . When the trajectory reaches the origin we can keep it there by switching to  $u = 0$  which makes the origin an equilibrium point.

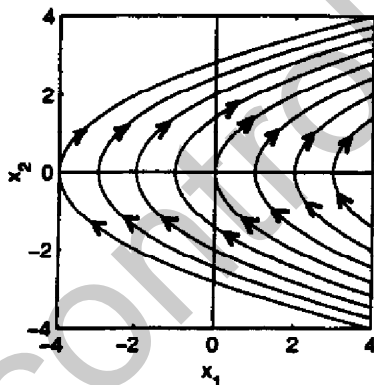

Figure 2.24: Exercise 2.15.

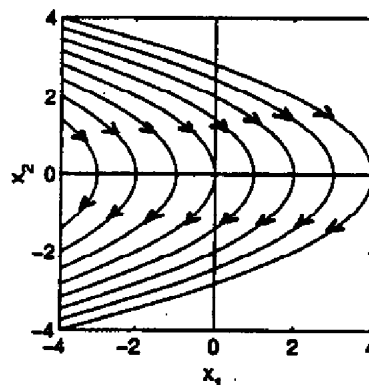

Figure 2.25: Exercise 2.15.

• 2.16 (a) The equilibrium points are the roots of

$$0 = x_1(1 - x_1 - ax_2), \quad 0 = bx_2(x_1 - x_2)$$

From the first equation, we have  $x_1 = 0$  or  $x_1 = 1 - ax_2$ . Substitution of  $x_1 = 0$  in the second equation results in  $x_2 = 0$ . Substitution of  $x_1 = 1 - ax_2$  in the second equation results in  $x_2(1 - ax_2 - x_2) = 0$  which yields

## 《非线性系统（第三版）》习题解答

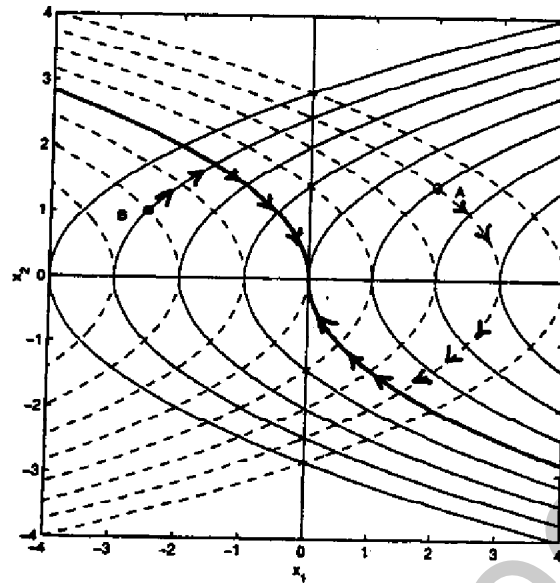

Figure 2.26: Exercise 2.15.

$x_2 = 0$  or  $x_2 = 1/(1+a)$ . Thus, there are three equilibrium points at  $(0,0)$ ,  $(1,0)$ , and  $(1/(1+a), 1/(1+a))$ . The Jacobian matrix is given by

$$\frac{\partial f}{\partial x} = \begin{bmatrix} 1 - 2x_1 - ax_2 & -ax_1 \\ bx_2 & bx_1 - 2bx_2 \end{bmatrix}$$

$$\frac{\partial f}{\partial x} \Big|_{(0,0)} = \begin{bmatrix} 1 & 0 \\ 0 & 0 \end{bmatrix}, \quad \frac{\partial f}{\partial x} \Big|_{(1,0)} = \begin{bmatrix} -1 & -a \\ 0 & b \end{bmatrix}, \quad \frac{\partial f}{\partial x} \Big|_{(\frac{1}{1+a}, \frac{1}{1+a})} = \frac{1}{1+a} \begin{bmatrix} -1 & -a \\ b & -b \end{bmatrix}$$

At the equilibrium point  $(0,0)$  the matrix has a zero eigenvalue; hence linearization fails to determine the type of the equilibrium point. At  $(1,0)$ , the equilibrium point is a saddle. At  $(\frac{1}{1+a}, \frac{1}{1+a})$ , the eigenvalues are

$$\lambda_{1,2} = \frac{-(1+b) \pm \sqrt{1-2b+b^2-4ab}}{2(1+a)}$$

Hence,  $(\frac{1}{1+a}, \frac{1}{1+a})$  is a stable node if  $1-2b+b^2-4ab > 0$  and a stable focus if  $1-2b+b^2-4ab < 0$ .

The phase portrait is shown in Figure 2.27. The equilibrium point  $(\frac{1}{2}, \frac{1}{2})$  is a stable focus that attracts all trajectories in the first quadrant except trajectories on the  $x_1$ -axis or the  $x_2$  axis. Trajectories on the  $x_1$ -axis move on it approaching the saddle point at  $(1,0)$ . Motion on the  $x_1$ -axis corresponds to the case when there are no predators, in which case the prey population settles at  $x_1 = 1$ . Motion on the  $x_2$  axis corresponds to the case when there are no preys, in which case the predator population settles at  $x_2 = 0$ ; i.e., the predators vanish. In the presence of both preys and predators, their populations reach a balance at the equilibrium point  $(\frac{1}{2}, \frac{1}{2})$ .

- 2.17 (1) Assume  $\varepsilon > 0$  and let  $x_1 = y$ ,  $x_2 = \dot{y}$ , and  $V(x) = x_1^2 + x_2^2$ .

$$\dot{x}_1 = x_2, \quad \dot{x}_2 = -x_1 + \varepsilon x_2(1 - x_1^2 - x_2^2)$$

$$f(x) \cdot \nabla V(x) = 2\varepsilon x_2^2(1 - x_1^2 - x_2^2) = 2\varepsilon x_2^2(1 - V)$$

## 《非线性系统（第三版）》习题解答

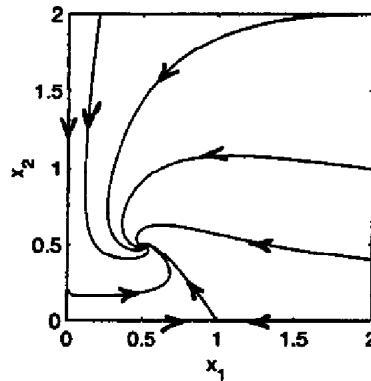

Figure 2.27: Exercise 2.16.

Hence,  $f(x) \cdot \nabla V(x) \leq 0$  for  $V(x) \geq 1$ . In particular, all trajectories starting in  $M = \{V(x) \leq 1\}$  stay in  $M$  for all future time.  $M$  contains only one equilibrium point at the origin. Linearization at the origin yields the matrix  $\begin{bmatrix} 0 & 1 \\ -1 & \varepsilon \end{bmatrix}$ . Hence, the origin is unstable node or unstable focus. By the Poincaré-Bendixson criterion, there is a periodic orbit in  $M$ .

(2) Let  $V(x) = x_1^2 + x_2^2$ .

$$f(x) \cdot \nabla V(x) = 2x_2^2(2 - 3x_1^2 - 2x_2^2) = 4x_2^2(1 - x_1^2 - x_2^2) - 2x_1^2x_2^2 \leq 4x_2^2(1 - x_1^2 - x_2^2)$$

Hence,  $f(x) \cdot \nabla V(x) \leq 0$  for  $x_1^2 + x_2^2 \geq 1$ . In particular, all trajectories starting in  $M = \{V(x) \leq 1\}$  stay in  $M$  for all future time.  $M$  contains only one equilibrium point at the origin. Linearization at the origin yields the matrix  $\begin{bmatrix} 0 & 1 \\ -1 & 2 \end{bmatrix}$ , whose eigenvalues are 1 and 1. Since  $f(x)$  is an analytic function of  $x$ , we conclude that the origin is unstable node. By the Poincaré-Bendixson criterion, there is a periodic orbit in  $M$ .

(3) Let  $V(x) = 3x_1^2 + 2x_1x_2 + 2x_2^2$ .

$$\begin{aligned}
 f(x) \cdot \nabla V(x) &= (6x_1 + 2x_2)x_2 + (2x_1 + 4x_2)[-x_1 + x_2 - 2(x_1 + 2x_2)x_2^2] \\
 &= -2x_1^2 + 4x_1x_2 + 6x_2^2 - 4(x_1 + 2x_2)^2x_2^2 \\
 &= -2(x_1^2 + x_2^2) + 4x_2(x_1 + 2x_2) - 4(x_1 + 2x_2)^2x_2^2 \\
 &= -2(x_1^2 + x_2^2) + 1 - [1 - 2x_2(x_1 + 2x_2)]^2 \\
 &\leq -2(x_1^2 + x_2^2) + 1 \leq 0, \text{ for } x_1^2 + x_2^2 \geq \frac{1}{2}
 \end{aligned}$$

Choose a constant  $c > 0$  such that the surface  $V(x) = c$  contains the circle  $\{x_1^2 + x_2^2 = \frac{1}{2}\}$  in its interior. Then, all trajectories starting in  $M = \{V(x) \leq c\}$  stay in  $M$  for all future time.  $M$  contains only one equilibrium point at the origin. Linearization at the origin yields the matrix  $\begin{bmatrix} 0 & 1 \\ -1 & 1 \end{bmatrix}$ , whose eigenvalues are  $(1 \pm j\sqrt{3})/2$ . Hence, the origin is unstable focus. By the Poincaré-Bendixson criterion, there is a periodic orbit in  $M$ .

(4) The equilibrium points are the roots of

$$0 = x_1 + x_2 - x_1 \max\{|x_1|, |x_2|\}, \quad 0 = -2x_1 + x_2 - x_2 \max\{|x_1|, |x_2|\}$$

From the first equation, we have  $x_2 = x_1(\max\{|x_1|, |x_2|\} - 1)$ . Substitution in the second equation results in

$$0 = -2x_1 - x_1(\max\{|x_1|, |x_2|\} - 1)^2 = -x_1[2 + (\max\{|x_1|, |x_2|\} - 1)^2] \Rightarrow x_1 = 0 \Rightarrow x_2 = 0$$

## 《非线性系统（第三版）》习题解答

Hence there is a unique equilibrium point at the origin. Linearization at the origin yields the matrix  $A = \begin{bmatrix} 1 & 1 \\ -2 & 1 \end{bmatrix}$  whose eigenvalues are  $1 \pm j1.4142$ . Hence, the origin is an unstable focus. Now consider  $V(x) = x_1^2 + x_2^2$ .

$$\begin{aligned} \nabla V \cdot f &= 2x_1(x_1 + x_2 - x_1 \max\{|x_1|, |x_2|\}) + 2x_2(-2x_1 + x_2 - x_2 \max\{|x_1|, |x_2|\}) \\ &= 2x_1^2 - 2x_1x_2 + 2x_2^2 - 2(x_1^2 + x_2^2) \max\{|x_1|, |x_2|\} \\ &= 2[x^T P x - \|x\|_2^2 \max\{|x_1|, |x_2|\}], \quad \text{where } P = \begin{bmatrix} 1 & -0.5 \\ -0.5 & 1 \end{bmatrix} \end{aligned}$$

The matrix  $P$  is positive definite with maximum eigenvalue 1.5. Therefore,

$$\nabla V \cdot f \leq 2[1.5\|x\|_2^2 - \|x\|_2^2 \max\{|x_1|, |x_2|\}] < 0, \quad \text{for } \max\{|x_1|, |x_2|\} > 1.5$$

Thus, by choosing  $c$  large enough,  $\nabla V \cdot f$  will be negative on the surface  $\{V(x) = c\}$ . Hence, all trajectories starting in the set  $M = \{V(x) \leq c\}$  stay in  $M$  for all future time and  $M$  contains a single equilibrium point which is unstable focus. It follows from the Poincaré-Bendixson's criterion that there is a periodic orbit in  $M$ .

### • 2.18

(a)

$$\dot{V} = x_2 \dot{x}_2 + g(x_1) \dot{x}_1 = -x_2 g(x_1) + x_2 g(x_1) = 0$$

(b) For small  $c > 0$ , the equation  $V(x) = c$  defines a closed curve that encloses the origin. Since  $\dot{V} = 0$ , a trajectory starting on the curve must remain on the curve for all  $t$ . Moreover, from  $\dot{x}_1 = x_2$ , we see that the trajectory can only move in the clockwise direction. Hence, a trajectory starting at any point on the closed curve  $V(x) = c$  must move around the curve until it comes back to the starting point. Thus, the trajectory is a periodic orbit.

(c) Extension of (b) because  $V(x) = c$  is a closed curve for all  $c > 0$ .

(d)  $V(x) = \frac{1}{2}x_2^2 + G(x_1) = \text{constant}$ . At  $x = (A, 0)$ ,  $V = G(A)$ . Thus

$$\frac{1}{2}x_2^2(t) + G(x_1(t)) \equiv G(A) \Rightarrow x_2(t) \equiv \pm \sqrt{2[G(A) - G(x_1(t))]}$$

(e) Starting from  $\dot{x}_1 = x_2$ , we have

$$dt = \frac{dx_1}{\sqrt{2[G(A) - G(x_1)]}}$$

for  $x_2 \geq 0$ . Calculating the line integral of the right-hand side in the upper half of the plane from  $(-A, 0)$  to  $(A, 0)$ , we obtain

$$\frac{T}{2} = \int_{-A}^A \frac{dy}{\sqrt{2[G(A) - G(y)]}} \Rightarrow T = 2\sqrt{2} \int_0^A \frac{dy}{\sqrt{G(A) - G(y)}}$$

where we have used the fact that  $G(x_1)$  is an even function.

(f) We can generate the trajectories using the equation in part (d). For each value of  $A$ , we solve the equation to find  $x_2$  as a function of  $x_1$ . The function  $G(x_1)$  has a minimum, a maximum, or a point of inflection at each equilibrium point of the system. In particular, It has a minimum at  $x_1 = 0$  corresponding to the equilibrium point at the origin. Starting from small values of  $A$ , the equation will have a solution defining a closed orbit. As we increase the value of  $A$ , the equation will continue to define a closed orbit until  $A$  reaches the level of a maximum point of  $G(x_1)$ . For values of  $A$  higher than the maximum, the curves will not be closed. Depending on the shape of  $G(x_1)$ , the equation may have multiple solutions defining trajectories in different parts of the plane. The conditions of part(c) ensure that  $G(x_1)$  will have a global minimum at  $x_1 = 0$ .



## 《非线性系统（第三版）》习题解答

• **2.19** The phase portraits can be generated by solving the equation of the previous exercise either graphically or using a computer. We will only give the function  $G(x_1)$  and calculate the period of the trajectory through  $(1, 0)$ .

(1)

$$G(y) = \int_0^y \sin z \, dz = 1 - \cos y$$

$$T = 2\sqrt{2} \int_0^1 \frac{dy}{\sqrt{\cos y - \cos 1}}$$

(2)

$$G(y) = \int_0^y (z + z^3) \, dz = \frac{1}{2}y^2 + \frac{1}{4}y^4$$

$G(y) \rightarrow \infty$  as  $|y| \rightarrow \infty$  and  $zg(z) \geq 0$  for all  $z$ . Hence, every solution is periodic.

$$T = 2\sqrt{2} \int_0^1 \frac{dy}{\sqrt{\frac{3}{4} - \frac{1}{2}y^2 - \frac{1}{4}y^4}}$$

(3)

$$G(y) = \int_0^y z^3 \, dz = \frac{1}{4}y^4$$

$G(y) \rightarrow \infty$  as  $|y| \rightarrow \infty$  and  $zg(z) \geq 0$  for all  $z$ . Hence, every solution is periodic.

$$T = 2\sqrt{2} \int_0^1 \frac{dy}{\sqrt{\frac{1}{4} - \frac{1}{4}y^4}}$$

• **2.20**

(1)

$$\frac{\partial f_1}{\partial x_1} + \frac{\partial f_2}{\partial x_2} = -1 + a \neq 0$$

By Bendixson's criterion, there are no periodic orbits.

(2) The equilibrium points are the roots of

$$0 = x_1(-1 + x_1^2 + x_2^2), \quad 0 = x_2(-1 + x_1^2 + x_2^2)$$

The system has an isolated equilibrium point at the origin and a continuum of equilibrium points on the unit circle  $x_1^2 + x_2^2 = 1$ . It can be checked that the origin is a stable node. Transform the system into the polar coordinates  $x_1 = r \cos \theta$ ,  $x_2 = r \sin \theta$ . It can be verified that

$$\dot{r} = -r(1 - r^2)$$

For  $r < 1$ , every trajectory starting inside the unit circle approaches the origin as  $t \rightarrow \infty$ . For  $r > 1$ , every trajectory starting outside the unit circle escapes to  $\infty$  as  $t \rightarrow \infty$ . Thus, there are no limit cycles.

(3) The equilibrium points of the system are the roots of

$$0 = 1 - x_1x_2^2, \quad 0 = x_1$$

These equations have no real roots. Thus, there are no equilibrium points. Since, by Corollary 2.1, a closed orbit must enclose an equilibrium point, we conclude that there are no closed orbits.

## 《非线性系统（第三版）》习题解答

(4) The  $x_1$ -axis is an equilibrium set. Therefore, a periodic orbit cannot cross the  $x_1$ -axis; it must lie entirely in the upper or lower halves of the plane. However, there are no equilibrium points other than the  $x_1$ -axis. Since, by Corollary 2.1, a periodic orbit must enclose an equilibrium point, we conclude that there are no periodic orbits.

(5) The equilibrium points are the roots of

$$0 = x_2 \cos x_1, \quad 0 = \sin x_1$$

The equilibrium points are  $(\pm n\pi, 0)$  for  $n = 0, 1, 2, \dots$ . Linearization at the equilibrium points yields the matrix  $\begin{bmatrix} 0 & a \\ a & 0 \end{bmatrix}$  where  $a = \pm 1$ . Hence, all equilibrium points are saddles. Since, by Corollary 2.1, a periodic orbit must enclose equilibrium points such that  $N - S = 1$ , we conclude that there are no periodic orbits.

• 2.21

(a) Let

$$V(x) = x_2 - \frac{x_1 + b}{x_1 + a}$$

The function  $V(x)$  is negative in  $D$  and the curve  $V(x) = 0$  is the boundary of the set  $D$ .

$$f(x) \cdot \nabla V(x) = -cx_1(x_1 + a) + \frac{(b-a)}{(x_1 + a)^2}[-x_1 + x_2(x_1 + a) - b]$$

Evaluating  $f(x) \cdot \nabla V(x)$  on the curve  $V(x) = 0$  yields

$$f(x) \cdot \nabla V(x)|_{V(x)=0} = -cx_1(x_1 + a) < 0, \quad \forall x \in \partial D$$

Hence, trajectories on the boundary of  $D$  must move into  $D$ , which shows that trajectories starting in  $D$  cannot leave it.

(b)

$$\frac{\partial f_1}{\partial x_1} + \frac{\partial f_2}{\partial x_2} = -1 + x_2 < 0, \quad \forall x \in D$$

By Bendixson's criterion, there can be no closed orbits entirely in  $D$ . Since trajectories starting in  $D$  cannot leave it, a closed orbit through any point in  $D$  must lie entirely in  $D$ . Thus, we conclude that there are no closed orbits through any point in  $D$ .

• 2.22 (a) The value of  $\dot{x}_2$  on the  $x_1$ -axis is  $\dot{x}_2 = bx_1^2 \geq 0$ . Thus, trajectories starting in  $D$  cannot leave it.

(b)

$$\frac{\partial f_1}{\partial x_1} + \frac{\partial f_2}{\partial x_2} = a - x_2 - c \leq -(c-a) < 0, \quad \forall x \in D$$

By Bendixson's criterion, there can be no closed orbits entirely in  $D$ . Since trajectories starting in  $D$  cannot leave it, a closed orbit through any point in  $D$  must lie entirely in  $D$ . Thus, we conclude that there are no closed orbits through any point in  $D$ .

• 2.23

(a)

$$\frac{\partial f_1}{\partial x_1} + \frac{\partial f_2}{\partial x_2} = -a[2b - g(x_1)] = \begin{cases} -2ab & \text{for } |x_1| > 1 \\ -a(2b - k) & \text{for } |x_1| \leq 1 \end{cases}$$

$$k < 2b \Rightarrow \frac{\partial f_1}{\partial x_1} + \frac{\partial f_2}{\partial x_2} < 0, \quad \forall x$$

## 《非线性系统（第三版）》习题解答

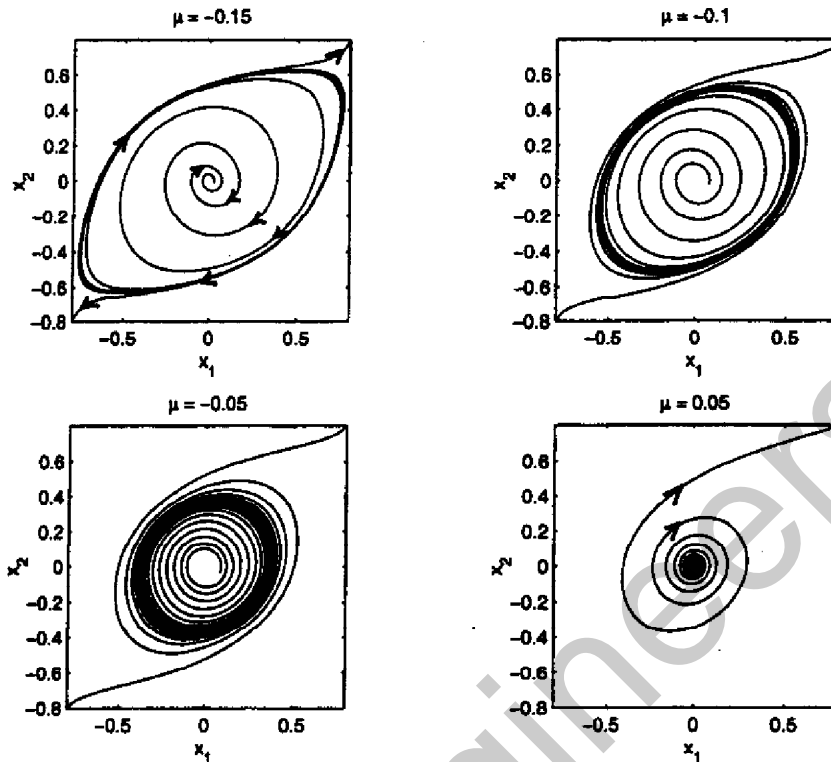

Figure 2.29: Exercise 2.27(2).

Hence, the origin is a stable focus for  $\mu < 0$  and unstable focus for  $\mu > 0$ . The phase portrait for different values of  $\mu$  is shown in Figure 2.29. For  $\mu < 0$ , there is a stable focus at the origin and unstable limit cycle around the origin. The size of the limit cycle shrinks as  $\mu$  tends to zero. For  $\mu > 0$ , the origin is an unstable focus and the limit cycle disappears. Hence, there is a subcritical Hopf bifurcation at  $\mu = 0$ .

(3) The equilibrium points are the real roots of

$$\begin{aligned}
 0 &= x_2, & 0 &= \mu - x_2 - x_1^2 - 2x_1x_2 \\
 x_2 &= 0 & \Rightarrow & x_1^2 = \mu
 \end{aligned}$$

When  $\mu < 0$ , there are no equilibrium points. When  $\mu > 0$ , there are two equilibrium points at  $(\sqrt{\mu}, 0)$  and  $(-\sqrt{\mu}, 0)$

$$\left. \frac{\partial f}{\partial x} \right|_{(\sqrt{\mu}, 0)} = \begin{bmatrix} 0 & 1 \\ -2\sqrt{\mu} & -(1+2\sqrt{\mu}) \end{bmatrix} \Rightarrow \lambda_{1,2} = -1, -2\sqrt{\mu} \Rightarrow (\sqrt{\mu}, 0) \text{ is a stable node}$$

$$\left. \frac{\partial f}{\partial x} \right|_{(-\sqrt{\mu}, 0)} = \begin{bmatrix} 0 & 1 \\ 2\sqrt{\mu} & -(1-2\sqrt{\mu}) \end{bmatrix} \Rightarrow \lambda_{1,2} = -1, 2\sqrt{\mu} \Rightarrow (-\sqrt{\mu}, 0) \text{ is a saddle}$$

There is a saddle-node bifurcation at  $\mu = 0$ .

(4) The equilibrium points are the real roots of

$$0 = x_2, \quad 0 = -(1 + \mu^2)x_1 + 2\mu x_2 + \mu x_1^3 - x_1^2 x_2$$

## 《非线性系统（第三版）》习题解答

• **2.24** Suppose  $M$  does not contain an equilibrium point. Then, by the Poincaré-Bendixson criterion, there is a periodic orbit in  $M$ . But, by Corollary 2.1, the periodic orbit must contain an equilibrium point: A contradiction. Thus,  $M$  contains an equilibrium point.

• **2.25** Verifying Lemma 2.3 by examining the vector fields is simple, but requires drawing several sketches. Hence, it is skipped.

• **2.26**

(1) Linearization at the origin yields  $\begin{bmatrix} 0 & 0 \\ 0 & -1 \end{bmatrix}$ . Hence, the origin is not hyperbolic. The index of the origin is zero. This can be easily seen by noting that  $f_1 = x_1^2$  is always nonnegative. Clearly, the vector field cannot make a full rotation as we encircle the origin because this will require  $f_1$  to be negative.

(2) Linearization at the origin yields  $\begin{bmatrix} 0 & 0 \\ 0 & 0 \end{bmatrix}$ . Hence, the origin is not hyperbolic. The index of the origin is two. This can be seen by sketching the vector field along a closed curve around the origin.

• **2.27** (1) The equilibrium points are the real roots of

$$0 = x_2, \quad 0 = \mu(x_1 + x_2) - x_2 - x_1^3 - 3x_1^2x_2$$

$$x_2 = 0 \Rightarrow 0 = x_1(\mu - x_1^2) \Rightarrow x_1 = 0 \text{ or } x_1^2 = \mu$$

For  $\mu > 0$ , there are three equilibrium points at  $(0, 0)$ ,  $(\sqrt{\mu}, 0)$ , and  $(-\sqrt{\mu}, 0)$ .

$$\frac{\partial f}{\partial x} = \begin{bmatrix} 0 & 1 \\ \mu - 3x_1^2 - 6x_1x_2 & \mu - 1 - 3x_1^2 \end{bmatrix}$$

$$\frac{\partial f}{\partial x} \Big|_{(0,0)} = \begin{bmatrix} 0 & 1 \\ \mu & \mu - 1 \end{bmatrix} \Rightarrow \lambda_{1,2} = -1, \mu \Rightarrow (0, 0) \text{ is a saddle}$$

$$\frac{\partial f}{\partial x} \Big|_{(\sqrt{\mu},0)} = \begin{bmatrix} 0 & 1 \\ -2\mu & -1 - 2\mu \end{bmatrix} \Rightarrow \lambda_{1,2} = -2\mu, -1 \Rightarrow (\sqrt{\mu}, 0) \text{ is a stable node}$$

Similarly,  $(-\sqrt{\mu}, 0)$  is a stable node. For  $\mu < 0$ , there is a unique equilibrium point at  $(0, 0)$ .

$$\frac{\partial f}{\partial x} \Big|_{(0,0)} = \begin{bmatrix} 0 & 1 \\ \mu & \mu - 1 \end{bmatrix} \Rightarrow \lambda_{1,2} = -1, \mu \Rightarrow (0, 0) \text{ is a stable node}$$

Thus, there is supercritical pitchfork bifurcation at  $\mu = 0$ .

(2) The equilibrium points are the real roots of

$$0 = -x_1^3 + x_2, \quad 0 = -(1 + \mu^2)x_1 + 2\mu x_2 - \mu x_1^3 + 2(x_2 - \mu x_1)^3$$

$$x_2 = x_1^3 \Rightarrow 0 = x_1 \{-1 + (x_1^2 - \mu)[\mu + 2x_1^2(x_1^2 - \mu)^2]\}$$

For all values of  $\mu$ , there is an equilibrium point at  $(0, 0)$ . At  $\mu = 0$ , there are two other equilibrium points at  $(a, a^3)$  and  $(-a, -a^3)$ , where  $a^8 = 0.5$ . It can be checked that these two equilibrium points are saddles. By continuous dependence of the roots of a polynomial equation on its parameters, we see that there is a range of values of  $\mu$  around zero for which these two saddle points will persist. We will limit our attention to such values of  $\mu$  and study local bifurcation at  $\mu = 0$ .

$$\frac{\partial f}{\partial x} \Big|_{(0,0)} = \begin{bmatrix} 0 & 1 \\ -(1 + \mu^2) & 2\mu \end{bmatrix} \Rightarrow \lambda_{1,2} = \mu \pm j$$

## 《非线性系统（第三版）》习题解答

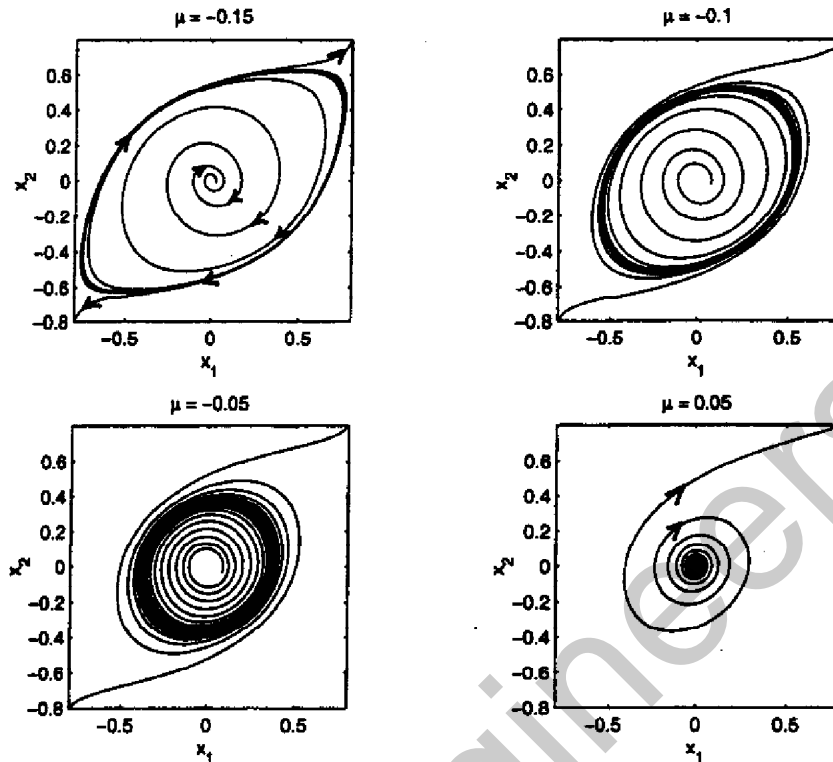

Figure 2.29: Exercise 2.27(2).

Hence, the origin is a stable focus for  $\mu < 0$  and unstable focus for  $\mu > 0$ . The phase portrait for different values of  $\mu$  is shown in Figure 2.29. For  $\mu < 0$ , there is a stable focus at the origin and unstable limit cycle around the origin. The size of the limit cycle shrinks as  $\mu$  tends to zero. For  $\mu > 0$ , the origin is an unstable focus and the limit cycle disappears. Hence, there is a subcritical Hopf bifurcation at  $\mu = 0$ .

(3) The equilibrium points are the real roots of

$$\begin{aligned} 0 &= x_2, & 0 &= \mu - x_2 - x_1^2 - 2x_1x_2 \\ x_2 &= 0 & \Rightarrow & x_1^2 = \mu \end{aligned}$$

When  $\mu < 0$ , there are no equilibrium points. When  $\mu > 0$ , there are two equilibrium points at  $(\sqrt{\mu}, 0)$  and  $(-\sqrt{\mu}, 0)$

$$\frac{\partial f}{\partial x} \Big|_{(\sqrt{\mu}, 0)} = \begin{bmatrix} 0 & 1 \\ -2\sqrt{\mu} & -(1+2\sqrt{\mu}) \end{bmatrix} \Rightarrow \lambda_{1,2} = -1, -2\sqrt{\mu} \Rightarrow (\sqrt{\mu}, 0) \text{ is a stable node}$$

$$\frac{\partial f}{\partial x} \Big|_{(-\sqrt{\mu}, 0)} = \begin{bmatrix} 0 & 1 \\ 2\sqrt{\mu} & -(1-2\sqrt{\mu}) \end{bmatrix} \Rightarrow \lambda_{1,2} = -1, 2\sqrt{\mu} \Rightarrow (-\sqrt{\mu}, 0) \text{ is a saddle}$$

There is a saddle-node bifurcation at  $\mu = 0$ .

(4) The equilibrium points are the real roots of

$$0 = x_2, \quad 0 = -(1 + \mu^2)x_1 + 2\mu x_2 + \mu x_1^3 - x_1^2 x_2$$

## 《非线性系统（第三版）》习题解答

$$x_2 = 0 \Rightarrow 0 = -(1 + \mu^2)x_1 + \mu x_1^3$$

For all values of  $\mu$ , there is an equilibrium point at  $(0, 0)$ . For  $\mu > 0$  there are two other equilibrium points at  $(a, 0)$  and  $(-a, 0)$ , where  $a = \sqrt{(1 + \mu^2)/\mu}$ .

$$\left. \frac{\partial f}{\partial x} \right|_{(0,0)} = \begin{bmatrix} 0 & 1 \\ -(1 + \mu^2) & 2\mu \end{bmatrix} \Rightarrow \lambda_{1,2} = \mu \pm j$$

Hence, the origin is a stable focus for  $\mu < 0$  and unstable focus for  $\mu > 0$ .

$$\left. \frac{\partial f}{\partial x} \right|_{(\pm a,0)} = \begin{bmatrix} 0 & 1 \\ 2(1 + \mu^2) & (-1 + \mu^2)/\mu \end{bmatrix} \Rightarrow \lambda_{1,2} = \frac{1}{2} \left[ -\left(\frac{1 - \mu^2}{\mu}\right) \pm \sqrt{\left(\frac{1 - \mu^2}{\mu}\right)^2 + 8(1 + \mu^2)} \right]$$

Hence,  $(a, 0)$  and  $(-a, 0)$  are saddle points. The phase portrait for different values of  $\mu$  is shown in Figure 2.30. For  $\mu < 0$ , there is a stable focus at the origin. For  $\mu > 0$ , the origin is an unstable focus and there is a stable limit cycle around the origin. The size of the limit cycle shrinks as  $\mu$  tends to zero. Hence, there is a supercritical Hopf bifurcation at  $\mu = 0$ . Also, as  $\mu$  becomes positive, the saddle points appear on the  $x_1$ -axis at  $x_1 = \pm\sqrt{(1 + \mu^2)/\mu}$ . The saddle points start at infinity and they move toward the origin as  $\mu$  increases, until they reach  $\pm 2$  at  $\mu = 1$ . Then they move again toward infinity. For  $\mu = 0.2$ , the phase portrait is shown in a larger area that includes the saddle points.

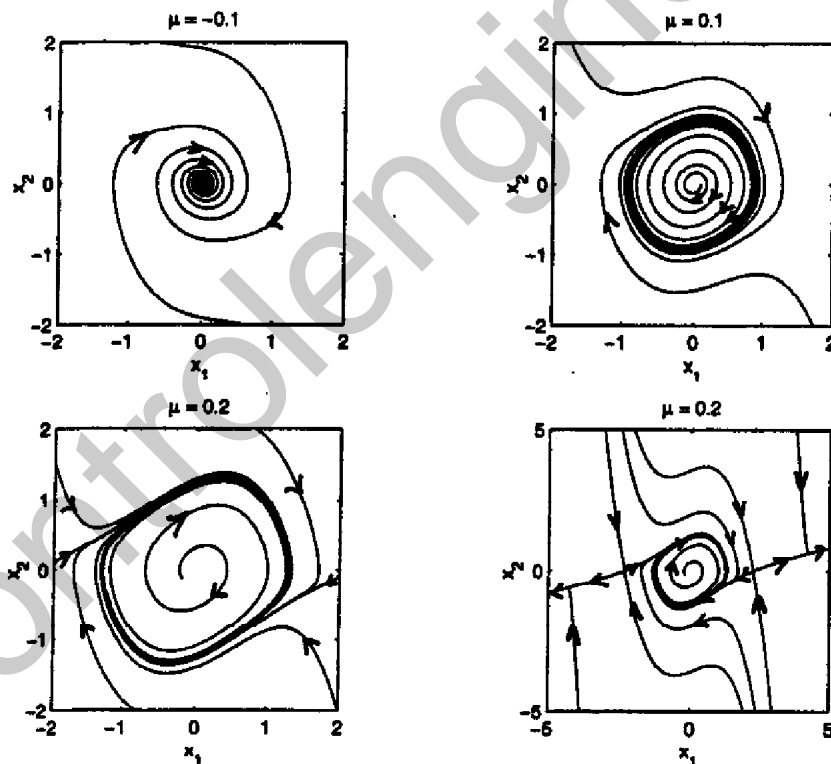

Figure 2.30: Exercise 2.27(4).

(5) The equilibrium points are the real roots of

$$0 = x_2, \quad 0 = \mu(x_1 + x_2) - x_2 - x_1^3 + 3x_1^2x_2$$

## 《非线性系统（第三版）》习题解答

$$x_2 = 0 \Rightarrow 0 = x_1(\mu - x_1^2)$$

For all values of  $\mu$ , there is an equilibrium point at  $(0, 0)$ . For  $\mu > 0$  there are two other equilibrium points at  $(\sqrt{\mu}, 0)$  and  $(-\sqrt{\mu}, 0)$ .

$$\left. \frac{\partial f}{\partial x} \right|_{(0,0)} = \begin{bmatrix} 0 & 1 \\ \mu & \mu - 1 \end{bmatrix} \Rightarrow \lambda_{1,2} = -1, \mu$$

Hence, the origin is a stable node for  $\mu < 0$  and a saddle for  $\mu > 0$ .

$$\left. \frac{\partial f}{\partial x} \right|_{(\pm\sqrt{\mu}, 0)} = \begin{bmatrix} 0 & 1 \\ -2\mu & (4\mu - 1) \end{bmatrix} \Rightarrow \lambda_{1,2} = \frac{-(1 - 4\mu) \pm \sqrt{(1 - 4\mu)^2 - 8\mu}}{2}$$

The following table gives the type of the equilibrium points  $(\sqrt{\mu}, 0)$  and  $(-\sqrt{\mu}, 0)$  for various positive values of  $\mu$ .

Range	Type
$0 < \mu < 0.067$	Stable node
$0.067 < \mu < 0.25$	Stable focus
$0.25 < \mu < 0.933$	Unstable focus
$0.933 < \mu$	Unstable node

Thus, there is a supercritical pitchfork bifurcation at  $\mu = 0$ . We also examine  $\mu = 0.25$ , where the equilibrium points  $(\sqrt{\mu}, 0)$  and  $(-\sqrt{\mu}, 0)$  change from stable focus to unstable focus. The phase portraits for  $\mu = 0.24$  and  $\mu = 0.26$  are shown in Figure 2.31. As  $\mu$  crosses 0.25 new stable limit cycles are created around the points  $(\sqrt{\mu}, 0)$  and  $(-\sqrt{\mu}, 0)$ . Thus, there is a supercritical Hopf bifurcation at  $\mu = 0.25$ .



Figure 2.31: Exercise 2.27(5).

(6) The equilibrium points are the real roots of

$$0 = x_2, \quad 0 = \mu(x_1 + x_2) - x_2 - x_1^2 - 2x_1x_2$$

$$x_2 = 0 \Rightarrow 0 = x_1(\mu - x_1)$$

There are two equilibrium points at  $(0, 0)$  and  $(\mu, 0)$ .

$$\left. \frac{\partial f}{\partial x} \right|_{(0,0)} = \begin{bmatrix} 0 & 1 \\ \mu & \mu - 1 \end{bmatrix} \Rightarrow \lambda_{1,2} = -1, \mu$$

## 《非线性系统（第三版）》习题解答

Hence, the origin is a stable node for  $\mu < 0$  and a saddle for  $\mu > 0$ .

$$\left. \frac{\partial f}{\partial x} \right|_{(\mu,0)} = \begin{bmatrix} 0 & 1 \\ -\mu & -(\mu+1) \end{bmatrix} \Rightarrow \lambda_{1,2} = -1, -\mu$$

Hence,  $(\mu, 0)$  is a saddle for  $\mu < 0$  and a stable node for  $\mu > 0$ . There is a transcritical bifurcation at  $\mu = 0$ .

• 2.28 (a) The equilibrium points are the real roots of

$$0 = -\frac{1}{\tau}x_1 + \tanh(\lambda x_1) - \tanh(\lambda x_2), \quad 0 = -\frac{1}{\tau}x_2 + \tanh(\lambda x_1) + \tanh(\lambda x_2)$$

By adding and subtracting the two equations, we see that the equilibrium points are the intersections of the two curves

$$x_2 = -x_1 + 2\tau \tanh(\lambda x_1), \quad x_1 = x_2 - 2\tau \tanh(\lambda x_2)$$

Clearly there is an equilibrium point at the origin  $(0, 0)$ . By plotting the two curves for different values of  $\lambda\tau$  (see Figure 2.32), it can be seen that the origin is the only intersection point. In fact, the two curves touch each other asymptotically as  $\lambda\tau \rightarrow \infty$ . Thus, we conclude that the origin is the only equilibrium point. Next we use linearization to determine the type of the equilibrium point.

$$\left. \frac{\partial f}{\partial x} \right|_{x=0} = \begin{bmatrix} -\frac{1}{\tau} + \lambda \frac{1}{\cosh^2(\lambda x_1)} & -\lambda \frac{1}{\cosh^2(\lambda x_2)} \\ \lambda \frac{1}{\cosh^2(\lambda x_1)} & -\frac{1}{\tau} + \lambda \frac{1}{\cosh^2(\lambda x_2)} \end{bmatrix}$$

$$\left. \frac{\partial f}{\partial x} \right|_{x=0} = \begin{bmatrix} -\frac{1}{\tau} + \lambda & -\lambda \\ \lambda & -\frac{1}{\tau} + \lambda \end{bmatrix}, \quad \text{Eigenvalues: } \frac{(\lambda\tau - 1)}{\tau} \pm j\lambda$$

Hence, the origin is a stable focus for  $\lambda\tau < 1$  and unstable focus for  $\lambda\tau > 1$ . To apply the Poincare-Bendixson criterion when  $\lambda\tau > 1$ , we need to find a set  $M$  that satisfies the conditions of the criterion. We do it by transforming the equation into the polar coordinates

$$r = \sqrt{x_1^2 + x_2^2}, \quad \theta = \tan^{-1} \left( \frac{x_2}{x_1} \right)$$

$$\dot{r} = -\frac{1}{\tau}r + \cos(\theta)[\tanh(\lambda r \cos(\theta)) - \tanh(\lambda r \sin(\theta))] + \sin(\theta)[\tanh(\lambda r \cos(\theta)) + \tanh(\lambda r \sin(\theta))]$$

Using  $|\tanh(\cdot)| \leq 1$ ,  $|\cos(\cdot)| \leq 1$ , and  $|\sin(\cdot)| \leq 1$ , we see that

$$\dot{r} \leq -\frac{1}{\tau}r + 4$$

Choosing  $r = c > 4\tau$ , we conclude that on the circle  $r = c$ ,  $\dot{r} < 0$ . Hence, vector fields on  $r = c$  point to the inside of the circle. Thus, the set  $M = \{r \leq c\}$  has the property that every trajectory starting in  $M$  stays in  $M$  for all future time. Moreover,  $M$  is closed, bounded, and contains only one equilibrium point which is unstable focus. By the Poincare-Bendixson criterion, we conclude that there is a periodic orbit in  $M$ .

(b) The phase portrait is shown in Figure 2.33. The origin is an unstable focus and there is a stable limit cycle around it. All trajectories, except the trivial solution  $x = 0$ , approach the limit cycle asymptotically.

(c) The phase portrait is shown in Figure 2.33. The origin is a stable focus. All trajectories approach the origin asymptotically.

(d) For  $\lambda\tau < 1$ , there a stable focus at the origin. For  $\lambda\tau > 1$ , there is an unstable focus at the origin and a stable limit cycle around the origin. Hence, there is a supercritical Hopf bifurcation at  $\lambda\tau = 1$ .



## 《非线性系统（第三版）》习题解答

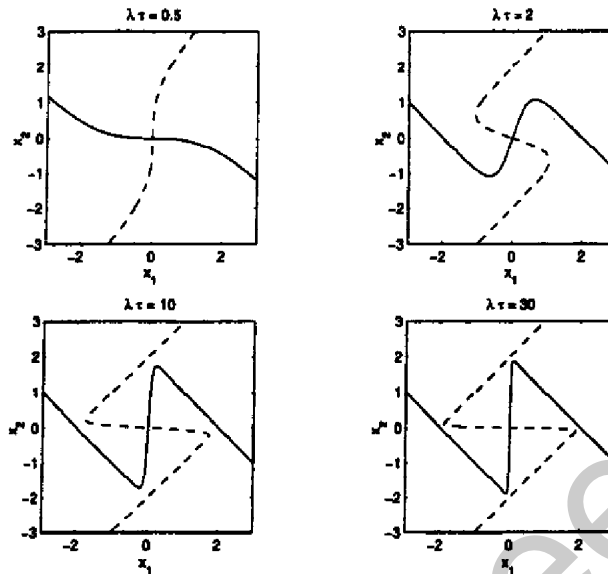

Figure 2.32: Exercise 2.28.

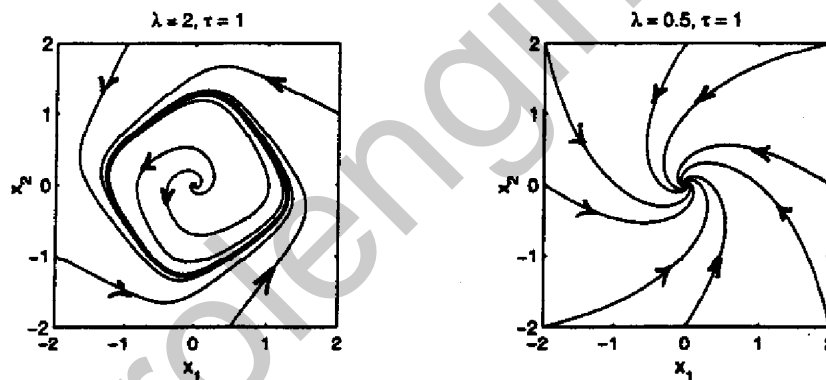

Figure 2.33: Exercise 2.28.

- 2.29 (a) The equilibrium points are the real roots of

$$0 = a - x_1 - \frac{4x_1x_2}{1+x_1^2}, \quad 0 = bx_1 \left( 1 - \frac{x_2}{1+x_1^2} \right)$$

From the second equation we have  $x_1 = 0$  or  $x_2 = 1 + x_1^2$ . The first equation cannot be satisfied with  $x_1 = 0$ . Substitution of  $x_2 = 1 + x_1^2$  in the first equation results in  $x_1 = a/5$ . Thus, there is a unique equilibrium point at  $((a/5), 1 + (a/5)^2)$ . The Jacobian matrix is given by

$$\frac{\partial f}{\partial x} = \begin{bmatrix} -1 - \frac{4x_2}{1+x_1^2} + \frac{8x_1^2x_2}{(1+x_1^2)^2} & -\frac{4x_1}{1+x_1^2} \\ b \left( 1 - \frac{x_2}{1+x_1^2} \right) + \frac{2bx_1^2x_2}{(1+x_1^2)^2} & -\frac{bx_1}{1+x_1^2} \end{bmatrix}$$

$$\frac{\partial f}{\partial x} \Big|_{((a/5), 1+(a/5)^2)} = \frac{1}{1+(a/5)^2} \begin{bmatrix} -5 + 3(a/5)^2 & -4(a/5) \\ 2b(a/5)^2 & -b(a/5) \end{bmatrix} = \frac{1}{1+(a/5)^2} B$$

## 《非线性系统（第三版）》习题解答

The characteristic equation of  $B$  is

$$s^2 + \beta s + \gamma = 0$$

where

$$\beta = 5 - 3(a/5)^2 + b(a/5), \quad \gamma = 5[1 + (a/5)^2]b(a/5)$$

We have  $\gamma > 0$ . If  $\beta < 0$ , the eigenvalues will be real and positive or complex with positive real parts; hence the equilibrium point will be unstable node or unstable focus.  $\beta$  is negative if  $b < 3(a/5) - 25/a$ . To apply the Poincare-Bendixson criterion, we need to choose the set  $M$ . Figure 2.34 sketches the two curves whose intersection determines the equilibrium point. On the sketch we identify a rectangle with vertices at  $A$ ,  $B$ ,  $C$  and  $D$ . On the line  $AB$ ,  $\dot{x}_2 > 0$ ; hence the vector fields point upward. On the line  $BC$ ,  $\dot{x}_1 < 0$ ; hence the vector fields point to the left. On the line  $CD$ ,  $\dot{x}_2 < 0$ ; hence the vector fields point downward. On the line  $DA$ ,  $\dot{x}_1 > 0$ ; hence the vector fields point to the right. Thus, taking the set  $M$  to be the rectangle  $ABCD$ , we see that every trajectory starting in  $M$  stays in  $M$  for all future time. Moreover,  $M$  is closed, bounded, and contains only one equilibrium point which is unstable node or unstable focus. By the Poincare-Bendixson criterion, we conclude that there is a periodic orbit in  $M$ .

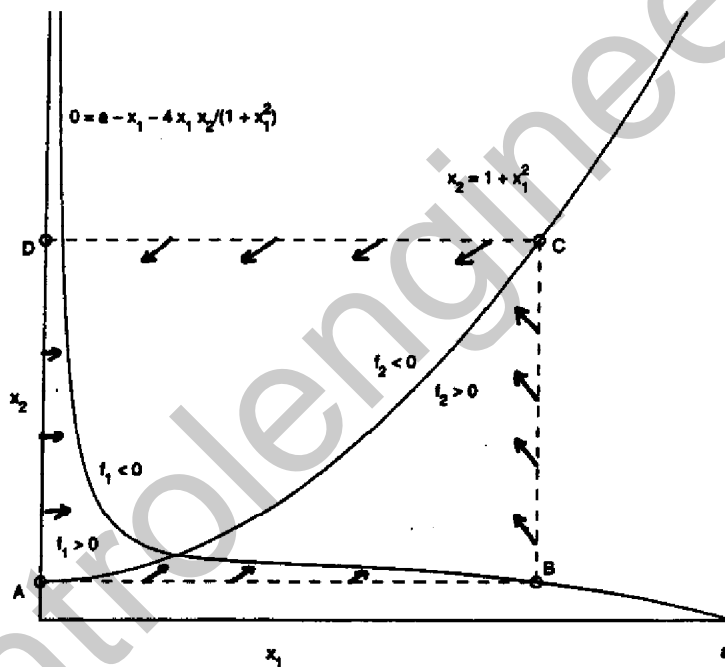

Figure 2.34: Exercise 2.29.

(b) For  $a = 10$  and  $b = 2$ , we have  $b < 3a/5 - 25/a$ . The equilibrium point is  $(2, 5)$  and it is unstable focus. The phase portrait is shown in Figure 2.35. The system has a stable limit cycle. All trajectories, except the equilibrium solution  $x = (2, 5)$ , approach the limit cycle asymptotically.

(c) For  $a = 10$  and  $b = 4$ , we have  $b > 3a/5 - 25/a$ . The equilibrium point is  $(2, 5)$  and it is a stable focus. The phase portrait is shown in Figure 2.35. All trajectories approach the equilibrium point asymptotically.

(d) For  $b < 3a/5 - 25/a$ ,  $\beta$  is negative. Moreover, when  $b$  is close to  $3a/5 - 25/a$ ,  $\beta$  will be close to zero. Hence,  $4\gamma > \beta^2$  and the equilibrium point is unstable focus. As we saw from the phase portrait, there

## 《非线性系统（第三版）》习题解答

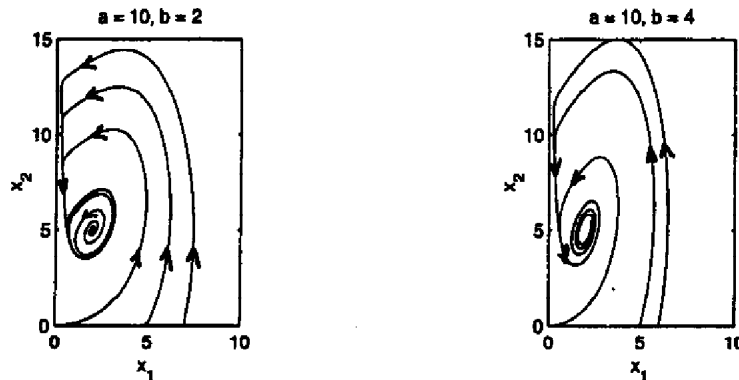

Figure 2.35: Exercise 2.29.

is a stable limit cycle around the equilibrium point. For  $b > 3a/5 - 25/a$ ,  $\beta$  is positive. Once again, when  $b$  is close to  $3a/5 - 25/a$ ,  $\beta$  will be close to zero. Hence,  $4\gamma > \beta^2$  and the equilibrium point is a stable focus. There is a supercritical Hopf bifurcation at  $b = 3a/5 - 25/a$ .

• 2.30 (a) The equilibrium points are the roots of

$$0 = \left( \frac{\mu_m x_2}{k_m + x_2} - d \right) x_1, \quad 0 = d(x_{2f} - x_2) - \frac{\mu_m x_1 x_2}{Y(k_m + x_2)}$$

The first equation has two solutions:  $x_1 = 0$  or the solution of  $d = \mu_m x_2 / (k_m + x_2)$ , which we denote by  $\alpha$ . When  $d < \mu_m$ , there is a unique solution  $\alpha$ . Substitution of  $x_1 = 0$  in the second equation yields  $x_2 = x_{2f}$ . Substitution of  $x_2 = \alpha$  in the second equation yields  $x_1 = Y(x_{2f} - \alpha)$ , which will be a feasible solution if  $\alpha \leq x_{2f}$ ; that is,  $d \leq \mu_m x_{2f} / (k_m + x_{2f})$ . Thus, when  $d \leq \mu_m x_{2f} / (k_m + x_{2f})$ , there are two equilibrium points at  $(0, x_{2f})$  and  $(Y(x_{2f} - \alpha), \alpha)$ . When  $d > \mu_m x_{2f} / (k_m + x_{2f})$ , there is a unique equilibrium point at  $(0, x_{2f})$ .

$$\frac{\partial f}{\partial x} = \begin{bmatrix} \frac{\mu_m x_2}{k_m + x_2} - d & \frac{k_m \mu_m x_1}{(k_m + x_2)^2} \\ \frac{-\mu_m x_2}{Y(k_m + x_2)} & -d - \frac{k_m \mu_m x_1}{Y(k_m + x_2)^2} \end{bmatrix}$$

$$\frac{\partial f}{\partial x} \Big|_{(0, x_{2f})} = \begin{bmatrix} \frac{\mu_m x_{2f}}{k_m + x_{2f}} - d & 0 \\ \frac{-\mu_m x_{2f}}{Y(k_m + x_{2f})} & -d \end{bmatrix}$$

Hence,  $(0, x_{2f})$  is a saddle if  $d < \mu_m x_{2f} / (k_m + x_{2f})$  and a stable node if  $d > \mu_m x_{2f} / (k_m + x_{2f})$ .

$$\frac{\partial f}{\partial x} \Big|_{(Y(x_{2f} - \alpha), \alpha)} = \begin{bmatrix} 0 & \frac{k_m \mu_m Y(x_{2f} - \alpha)}{(k_m + \alpha)^2} \\ -\frac{d}{Y} & -d - \frac{k_m \mu_m (x_{2f} - \alpha)}{(k_m + \alpha)^2} \end{bmatrix}$$

The eigenvalues are  $-d$  and  $-k_m \mu_m (x_{2f} - \alpha) / (k_m + \alpha)^2$ . For  $d < \mu_m x_{2f} / (k_m + x_{2f})$ ,  $(Y(x_{2f} - \alpha), \alpha)$  is a stable node. For the given numerical data,  $\mu_m x_{2f} / (k_m + x_{2f}) = 0.4878$ . When  $d > \mu_m$ , there is a unique equilibrium point at  $(0, x_{2f})$ , which is a stable node.

(b) The bifurcation diagram is shown in Figure 2.36. As  $d$  increases toward 0.4878, the saddle at  $(0, x_{2f})$  and the stable node at  $(Y(x_{2f} - \alpha), \alpha)$  collide and bifurcate into a stable node at  $(0, x_{2f})$ .

## 《非线性系统（第三版）》习题解答

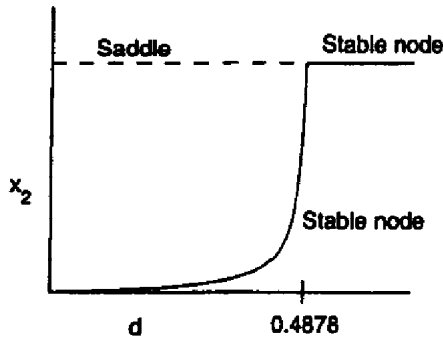

Figure 2.36: Exercise 2.30: Bifurcation diagram.

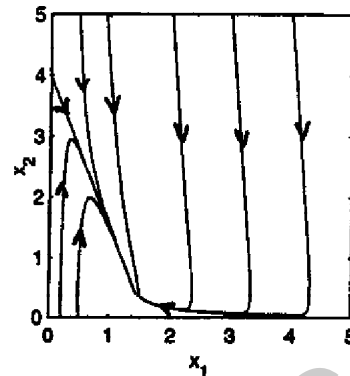

Figure 2.37: Exercise 2.30.

(c) For  $d = 0.4$ ,  $\alpha = k_m d / (\mu_m - d) = 0.4$ . Since  $d = 0.4 < 0.4878$ , there is a saddle at  $(0, 4)$  and a stable node at  $(1.44, 0.4)$ . The phase portrait is shown in Figure 2.37.

• 2.31 (a) Let

$$\mu(x_2) = \frac{\mu_m x_2}{k_m + x_2 + k_1 x_2^2}$$

The equilibrium points are the roots of

$$0 = x_1 [\mu(x_2) - d], \quad 0 = d(x_{2f} - x_2) - \frac{x_1 \mu(x_2)}{Y}$$

From the first equation,  $x_1 = 0$  or  $\mu(x_2) = d$ .

$$x_1 = 0 \Rightarrow x_2 = x_{2f}$$

$$\mu(x_2) = d \Rightarrow x_1 = Y(x_{2f} - x_2)$$

By sketching the function  $\mu(x_2)$ , it can be seen that if  $d < \max_{x_2 \geq 0} \{\mu(x_2)\}$ , the equation  $d = \mu(x_2)$  will have two solutions. Let us denote them by  $\alpha_1$  and  $\alpha_2$ . In this case, there are three equilibrium points at  $(0, x_{2f})$ ,  $(Y(x_{2f} - \alpha_1), \alpha_1)$ , and  $(Y(x_{2f} - \alpha_2), \alpha_2)$ , provided  $x_{2f} - \alpha_1$  and  $x_{2f} - \alpha_2$  are nonnegative numbers. If one of these numbers is negative, the corresponding equilibrium point is not feasible. If  $d > \max_{x_2 \geq 0} \{\mu(x_2)\}$ , the equation  $d = \mu(x_2)$  has no solutions. In this case, there is only one equilibrium point at  $(0, x_{2f})$ . The plot of  $\mu$  as a function of  $x_2$  is shown in Figure 2.38. By differentiation, it can be seen that  $\mu$  has a maximum value  $(\mu_m \sqrt{k_m/k_1}) / (2k_m + \sqrt{k_m/k_1}) = 0.3455$  at  $x_2 = \sqrt{k_m/k_1} = 0.4472$ . When  $d > 0.3455$ , there is a unique equilibrium point at  $(0, 4)$ , and when  $d < 0.3455$  there are three equilibrium points at  $(0, 4)$ ,  $(0.4(4 - \alpha_1), \alpha_1)$ , and  $(0.4(4 - \alpha_2), \alpha_2)$ , where  $\alpha_1 < 0.4472$  and  $\alpha_2 > 0.4472$  are the solutions of  $d = \mu(x_2)$ . In the case of  $\alpha_2$ , the equilibrium point  $(0.4(4 - \alpha_2), \alpha_2)$  is not feasible if  $\alpha_2 > 4$ . It can be checked that  $\mu = 0.1653$  at  $x_2 = 4$ . Hence, for  $d < 0.1653$ , there are only two equilibrium points at  $(0, 4)$  and  $(0.4(4 - \alpha_1), \alpha_1)$ . The Jacobian matrix is given by

$$\frac{\partial f}{\partial x} = \begin{bmatrix} -d + \frac{\mu_m x_2}{k_m + x_2 + k_1 x_2^2} & \frac{\mu_m x_1 (k_m - k_1 x_2^2)}{(k_m + x_2 + k_1 x_2^2)^2} \\ \frac{-\mu_m x_2}{Y(k_m + x_2 + k_1 x_2^2)} & -d - \frac{\mu_m x_1 (k_m - k_1 x_2^2)}{Y(k_m + x_2 + k_1 x_2^2)^2} \end{bmatrix} = \begin{bmatrix} -d + \frac{0.5x_2}{0.1 + x_2 + 0.5x_2^2} & \frac{0.5x_1(0.1 - kx_2^2)}{(0.1 + x_2 + 0.5x_2^2)^2} \\ \frac{-0.5x_2}{0.4(0.1 + x_2 + 0.5x_2^2)} & -d - \frac{0.5x_1(0.1 - kx_2^2)}{0.4(0.1 + x_2 + 0.5x_2^2)^2} \end{bmatrix}$$

At  $x = (0, 4)$ , the Jacobian matrix is

$$\begin{bmatrix} -d + 0.1653 & 0 \\ * & -d \end{bmatrix}$$

## 《非线性系统（第三版）》习题解答

When  $d > 0.1653$ , the equilibrium point is a stable node. When  $d < 0.1653$ , it is a saddle. At  $x = (0.4(4 - \alpha_1), \alpha_1)$ , the Jacobian matrix is

$$\begin{bmatrix} 0 & d^2 \beta Y \\ -d/Y & -d - d^2 \beta \end{bmatrix}$$

where  $\beta = (x_{2f} - \alpha_1)(k_m - k_1 \alpha_1^2) / \mu_m \alpha_1^2 > 0$ . The eigenvalues of this matrix are  $-d$  and  $-d^2 \beta$ . Hence, the equilibrium point is a stable node. At  $x = (0.4(4 - \alpha_2), \alpha_2)$  with  $\alpha_2 < 4$ , the Jacobian matrix is

$$\begin{bmatrix} 0 & d^2 \gamma Y \\ -d/Y & -d - d^2 \gamma \end{bmatrix}$$

where  $\gamma = (x_{2f} - \alpha_2)(k_m - k_1 \alpha_2^2) / \mu_m \alpha_2^2 < 0$ . The eigenvalues of this matrix are  $-d$  and  $-d^2 \gamma$ . Hence, the equilibrium point is a saddle. In summary, we have the following three cases:

- When  $d > 0.3455$ , there is one equilibrium point at  $(0, 4)$  which is a stable node.
- When  $0.1653 < d < 0.3455$ , there are three equilibrium points: a stable node at  $(0, 4)$ , a stable node at  $(0.4(4 - \alpha_1), \alpha_1)$ , and a saddle at  $(0.4(4 - \alpha_2), \alpha_2)$ .
- When  $d < 0.1653$ , there are two equilibrium points: a saddle at  $(0, 4)$  and a stable node at  $(0.4(4 - \alpha_1), \alpha_1)$ .

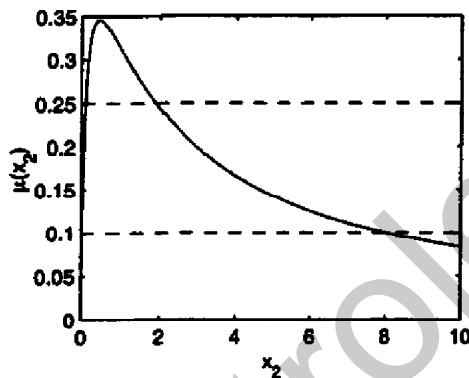

Figure 2.38: Exercise 2.31.

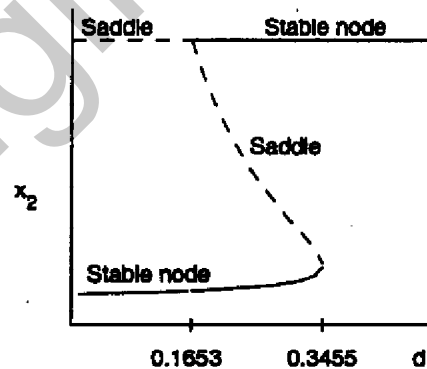

Figure 2.39: Exercise 2.31: Bifurcation diagram.

(b) The bifurcation diagram is shown in Figure 2.39. There is a saddle–node bifurcation at  $d = 0.3455$ . At  $d = 0.1653$  there is a type of bifurcation that is not shown in Figure 2.28. A saddle point bifurcates into a stable node and a new saddle is created.

(c) When  $d = 0.1$ , there are two equilibrium points:  $(0, 4)$  is a saddle and  $(1.59, 0.0251)$  is a stable node. The phase portrait is shown in Figure 2.40. The stable trajectories of the saddle are on the  $x_2$ -axis. All trajectories in the first quadrant approach the stable node.

(d) When  $d = 0.25$ , there are three equilibrium points:  $(0, 4)$  is a stable node,  $(1.5578, 0.1056)$  is a stable node, and  $(0.8426, 1.8936)$  is a saddle. The phase portrait is shown in Figure 2.41. The stable trajectories of the saddle form a separatrix which divides the first quadrant into two halves. All trajectories in the right half approach the stable node  $(1.5578, 0.1056)$ , while all trajectories in the left half approach the stable node  $(0, 4)$ .

《非线性系统（第三版）》习题解答

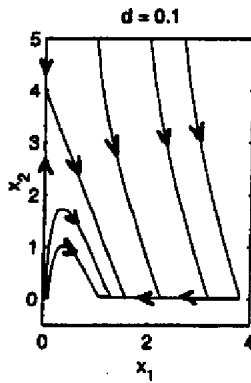

Figure 2.40: Exercise 2.31(c).

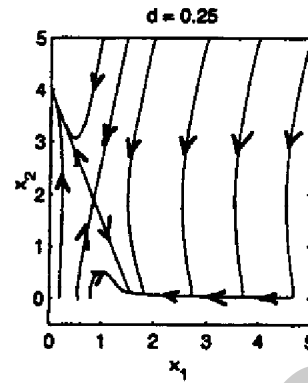

Figure 2.41: Exercise 2.31(d).

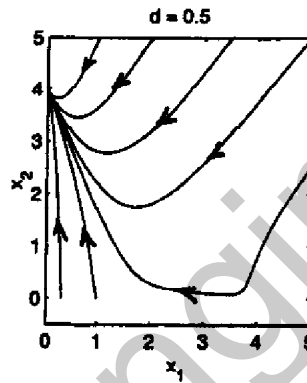

Figure 2.42: Exercise 2.31(e).

(e) When  $d = 0.5$ , there is one equilibrium point at  $(0, 4)$  which is a stable node. The phase portrait is shown in Figure 2.42. All trajectories in the first quadrant approach the stable node.

## 《非线性系统（第三版）》习题解答

### Chapter 3

• 3.1 (1) The term  $|x|$  is not continuously differentiable at  $x = 0$ , but it is globally Lipschitz. The term  $x^2$  is continuously differentiable, but its partial derivative is not globally bounded. Thus  $f = x^2 + |x|$  is not continuously differentiable at  $x = 0$ . It is continuously differentiable on a domain that does not include  $x = 0$ . It is locally Lipschitz, hence continuous, but not globally Lipschitz.

(2) The term  $\text{sgn}(x)$  is discontinuous at  $x = 0$ . Thus,  $f(x) = x + \text{sgn}(x)$  does not have any of the four properties in a domain that contains  $x = 0$ .

(3)  $f(x) = \sin(x) \text{sgn}(x)$  is globally Lipschitz. This can be seen as follows. If both  $x$  and  $y$  are nonnegative, we have

$$|f(x) - f(y)| = |\sin(x) - \sin(y)| \leq |x - y|$$

If  $x \geq 0$  and  $y \leq 0$ , we have

$$|f(x) - f(y)| = |\sin(x) + \sin(y)| = |2 \sin(\frac{1}{2}(x+y)) \cos(\frac{1}{2}(x-y))| \leq |x - y|$$

Other cases can be dealt with similarly to conclude that  $|f(x) - f(y)| \leq |x - y|$  for all  $x, y$ . It follows that  $f$  is both locally Lipschitz and continuous. It is not continuously differentiable at  $x = 0$  because  $\lim_{x \rightarrow 0^+} f'(x) = +1$  while  $\lim_{x \rightarrow 0^-} f'(x) = -1$ .

(4)  $f(x) = -x + a \sin x$  is continuously differentiable. Hence, it is locally Lipschitz and continuous.  $\frac{df}{dx} = -1 + a \cos x$  is globally bounded. Hence, it is globally Lipschitz.

(5)  $f(x) = -x + 2|x|$  is not continuously differentiable. It is globally Lipschitz because both  $x$  and  $|x|$  are so. Hence, it is locally Lipschitz.

(6)  $f(x) = \tan(x)$  is continuously differentiable in the open interval  $-\pi/2 < x < \pi/2$ . Hence, it is locally Lipschitz and continuous in the same interval. Its derivative  $\sec^2(x)$  is not globally bounded; hence, it is not globally Lipschitz.

(7) The function  $\tanh(y)$  is continuously differentiable and its derivative  $1/\cosh^2(y)$  is globally bounded; hence it is globally Lipschitz. Clearly, the linear function  $y$  is both continuously differentiable and globally Lipschitz. Hence,  $f$  has all four properties.

(8)  $f$  is not continuously differentiable due to the term  $|x_2|$  in  $f_1$ . Check the Lipschitz property component by component.  $f_1$  is globally Lipschitz as can be easily checked.  $f_2$  is continuously differentiable, but its partial derivatives are not globally bounded. Hence  $f_2$  is locally Lipschitz but not globally so. Since both  $f_1$  and  $f_2$  are locally Lipschitz, so is  $f$ . Since  $f$  is locally Lipschitz, it is continuous.  $f$  is not globally Lipschitz since  $f_2$  is not so.

• 3.2 (1)

$$f(x) = \begin{bmatrix} -\frac{g}{l} \sin x_1 - \frac{x_2}{m} + \frac{1}{m} T \end{bmatrix} \Rightarrow \frac{\partial f}{\partial x} = \begin{bmatrix} 0 & 1 \\ -\frac{g}{l} \cos x_1 & -\frac{1}{m} \end{bmatrix}$$

$[\partial f / \partial x]$  is globally bounded. Hence  $f$  is globally Lipschitz, which implies that it is locally Lipschitz on  $D_r$  for any  $r > 0$ .

(2)

$$f(x) = \begin{bmatrix} -\frac{1}{c} h(x_1) + \frac{1}{c} x_2 \\ -\frac{1}{l} x_1 - \frac{R}{l} x_2 + \frac{1}{l} u \end{bmatrix} \Rightarrow \frac{\partial f}{\partial x} = \begin{bmatrix} -\frac{1}{c} h'(x_1) & \frac{1}{c} \\ -\frac{1}{l} & -\frac{R}{l} \end{bmatrix}$$

## 《非线性系统（第三版）》习题解答

$[\partial f / \partial x]$  is continuous everywhere; hence it is bounded on the bounded set  $D_r$ . Thus  $f$  is locally Lipschitz on  $D_r$  for any finite  $r > 0$ . It is not globally Lipschitz since  $[\partial f / \partial x]$  is not globally bounded.

(3)

$$f(x) = \begin{bmatrix} x_2 \\ -\frac{k}{m}x_1 - \frac{c}{m}x_2 + \frac{1}{m}\eta(x_1, x_2) \end{bmatrix}$$

$\eta(x_1, x_2)$  is discontinuous at  $x_2 = 0$ . Hence it is not locally Lipschitz at the origin. This means it is not locally Lipschitz on  $D_r$  for any  $r > 0$ .

(4)

$$f(x) = \begin{bmatrix} x_2 \\ -x_1 - \varepsilon(1 - x_1^2)x_2 \end{bmatrix} \Rightarrow \frac{\partial f}{\partial x} = \begin{bmatrix} 0 & 1 \\ -1 - 2\varepsilon x_1 x_2 & -\varepsilon(1 - x_1^2) \end{bmatrix}$$

$[\partial f / \partial x]$  is continuous on  $D_r$ ; hence  $f$  is locally Lipschitz on  $D_r$  for any  $r > 0$ .  $[\partial f / \partial x]$  is not globally bounded; hence  $f$  is not globally Lipschitz.

(5) Let  $x = [e_o, \phi_1, \phi_2]^T$ .

$$f(t, x) = \begin{bmatrix} a_m x_1 + k_p x_2 r(t) + k_p x_3 (x_1 + y_m(t)) \\ -\gamma x_1 r(t) \\ -\gamma x_1 (x_1 + y_m(t)) \end{bmatrix} \Rightarrow \frac{\partial f}{\partial x} = \begin{bmatrix} a_m + k_p x_3 & k_p r(t) & k_p (x_1 + y_m(t)) \\ -\gamma r(t) & 0 & 0 \\ -\gamma(2x_1 + y_m(t)) & 0 & 0 \end{bmatrix}$$

$[\partial f / \partial x]$  is continuous and bounded on  $D_r$  for bounded  $r(t)$  and  $y_m(t)$ . Hence  $f$  is locally Lipschitz. It is not globally Lipschitz since  $[\partial f / \partial x]$  is not globally bounded.

(6)

$$f(x) = Ax - B\psi(Cx)$$

where  $\psi(\cdot)$  is a dead-zone nonlinearity. The dead-zone nonlinearity is globally Lipschitz. Hence  $f$  is globally Lipschitz, which implies that it is locally Lipschitz on  $D_r$  for any  $r > 0$ .

• 3.3 For each  $x_0 \in R$ , there exist positive constants  $r, L_1, L_2, k_1$ , and  $k_2$  such that

$$|f_1(x) - f_1(y)| \leq L_1|x - y|, |f_2(x) - f_2(y)| \leq L_2|x - y|, |f_1(x)| \leq k_1, |f_2(x)| \leq k_2$$

for all  $x, y \in \{x \in R \mid |x - x_0| < r\}$ . For  $f = f_1 + f_2$ , we have

$$|f(x) - f(y)| = |f_1(x) - f_1(y) + f_2(x) - f_2(y)| \leq L_1|x - y| + L_2|x - y| \leq (L_1 + L_2)|x - y|$$

For  $f = f_1 f_2$ , we have

$$\begin{aligned} |f(x) - f(y)| &= |f_1(x)f_2(x) - f_1(y)f_2(y)| = |f_1(x)f_2(x) - f_1(x)f_2(y) + f_1(x)f_2(y) - f_1(y)f_2(y)| \\ &\leq |f_1(x)| |f_2(x) - f_2(y)| + |f_2(y)| |f_1(x) - f_1(y)| \leq k_1 L_2|x - y| + k_2 L_1|x - y| \\ &\leq (k_1 L_2 + k_2 L_1)|x - y| \end{aligned}$$

For  $f = f_2 \circ f_1$ , we have

$$|f(x) - f(y)| = |f_2(f_1(x)) - f_2(f_1(y))| \leq L_2|f_1(x) - f_1(y)| \leq L_2 L_1|x - y|$$

• 3.4 The function  $f$  can be written as  $f(x) = g(x)Kxh(\psi(x))$  where

$$h(\psi) = \begin{cases} \frac{1}{\psi}, & \text{if } \psi \geq \mu > 0 \\ \frac{1}{\mu}, & \text{if } \psi < \mu \end{cases} \quad \text{and } \psi(x) = g(x)\|Kx\|$$

The norm function  $\|Kx\|$  is Lipschitz since

$$|\|Kx\| - \|Ky\|| \leq \|Kx - Ky\| \leq \|K\| \|x - y\|$$



## 《非线性系统（第三版）》习题解答

Using the previous exercise, we see that  $\psi(x)$  is Lipschitz on any compact set. Furthermore,  $g(x)Kx$  is also Lipschitz. Thus,  $f(x)$  will be Lipschitz on any compact set if we can show that  $h(\psi)$  is Lipschitz in  $\psi$  over any compact interval  $[0, b]$ . Now if  $\psi_1 \geq \mu$  and  $\psi_2 \geq \mu$ , we have

$$|h(\psi_2) - h(\psi_1)| = \left| \frac{1}{\psi_2} - \frac{1}{\psi_1} \right| = \left| \frac{\psi_1 - \psi_2}{\psi_1 \psi_2} \right| \leq \frac{1}{\mu^2} |\psi_2 - \psi_1|$$

If  $\psi_2 \geq \mu$  and  $\psi_1 < \mu$ , we have

$$|h(\psi_2) - h(\psi_1)| = \left| \frac{1}{\psi_2} - \frac{1}{\mu} \right| = \frac{1}{\mu} - \frac{1}{\psi_2} = \frac{\psi_2 - \mu}{\mu \psi_2} \leq \frac{\psi_2 - \psi_1}{\mu \psi_2} \leq \frac{1}{\mu^2} |\psi_2 - \psi_1|$$

If  $\psi_1 < \mu$  and  $\psi_2 < \mu$ , we have

$$|h(\psi_2) - h(\psi_1)| = \left| \frac{1}{\mu} - \frac{1}{\mu} \right| = 0 \leq \frac{1}{\mu^2} |\psi_2 - \psi_1|$$

Thus  $h(\psi)$  is Lipschitz with a Lipschitz constant  $1/\mu^2$ .

• 3.5 There are positive constants  $c_1$  and  $c_2$  such that

$$c_1 \|x\|_\alpha \leq \|x\|_\beta \leq c_2 \|x\|_\alpha, \quad \forall x \in \mathbb{R}^n$$

Suppose

$$\|f(y) - f(x)\|_\alpha \leq L_\alpha \|y - x\|_\alpha$$

Then

$$\|f(y) - f(x)\|_\beta \leq c_2 \|f(y) - f(x)\|_\alpha \leq c_2 L_\alpha \|y - x\|_\alpha \leq \frac{c_2 L_\alpha}{c_1} \|y - x\|_\beta$$

Similarly, it can be shown that if  $f$  is Lipschitz in the  $\beta$ -norm, it will be Lipschitz in the  $\alpha$ -norm.

• 3.6 (a)

$$\begin{aligned}
 x(t) &= x_0 + \int_{t_0}^t f(\tau, x(\tau)) d\tau \\
 \|x(t)\| &\leq \|x_0\| + \int_{t_0}^t \|f(\tau, x(\tau))\| d\tau \\
 &\leq \|x_0\| + \int_{t_0}^t [k_1 + k_2 \|x(\tau)\|] d\tau \\
 &= \|x_0\| + k_1(t - t_0) + k_2 \int_{t_0}^t \|x(\tau)\| d\tau
 \end{aligned}$$

By Gronwall-Bellman inequality

$$\|x(t)\| \leq \|x_0\| + k_1(t - t_0) + \int_{t_0}^t [\|x_0\| + k_1(s - t_0)] k_2 e^{k_2(t-s)} ds$$

Integrating by parts, we obtain

$$\|x(t)\| \leq \|x_0\| \exp[k_2(t - t_0)] + \frac{k_1}{k_2} \{\exp[k_2(t - t_0)] - 1\}, \quad \forall t \geq t_0$$

(b) The upper bound on  $\|x(t)\|$  is finite for every finite  $t$ . It tends to  $\infty$  as  $t \rightarrow \infty$ . Hence the solution of the system cannot have a finite escape time.

## 《非线性系统（第三版）》习题解答

- 3.7 It can be easily verified that  $f(x)$  is continuously differentiable. Hence, local existence and uniqueness follows from Theorem 3.1. Furthermore,

$$\|f(x)\|_2 = \frac{\|g(x)\|_2}{1 + \|g(x)\|_2^2} \leq \frac{1}{2}$$

Hence

$$\|x(t)\|_2 \leq \|x_0\|_2 + \frac{1}{2}(t - t_0)$$

which shows that the solution is defined for all  $t \geq t_0$ .

- 3.8 It can be easily seen that  $f(x)$  is continuously differentiable and

$$\|f(x)\| \leq k_1 + k_2\|x\|, \quad \forall x \in \mathbb{R}^2$$

for some positive constants  $k_1$  and  $k_2$ . Apply Exercise 3.6.

- 3.9 Due to uniqueness of solution, trajectories in the plane cannot intersect. Therefore, all trajectories starting in the region enclosed by the limit cycle must remain in that region. The closure of this region is a compact set. Therefore, the solution must stay in a compact set. Apply Theorem 3.3.

- 3.10

$$\dot{x}_1 = \frac{1}{C}[-h(x_1) + x_2], \quad \dot{x}_2 = \frac{1}{L}(-x_1 - Rx_2 + u)$$

where  $R = 1.5$ ,  $u = 1.2$ , and the nominal values of  $C$  and  $L$  are 2 and 5, respectively. Let  $\lambda = [C, L]^T$ . The Jacobian matrices  $[\partial f/\partial x]$  and  $[\partial f/\partial \lambda]$ , are given by

$$\frac{\partial f}{\partial x} = \begin{bmatrix} -\frac{1}{C}h'(x_1) & \frac{1}{C} \\ -\frac{1}{L} & -\frac{R}{L} \end{bmatrix}, \quad \frac{\partial f}{\partial \lambda} = \begin{bmatrix} -\frac{1}{Cx}[-h(x_1) + x_2] & 0 \\ 0 & -\frac{1}{Lx}(-x_1 - Rx_2 + u) \end{bmatrix}$$

Evaluate these Jacobian matrices at the nominal values  $C = 2$  and  $L = 5$ . Let

$$S = \left. \frac{\partial x}{\partial \lambda} \right|_{\text{nominal}} = \begin{bmatrix} x_3 & x_5 \\ x_4 & x_6 \end{bmatrix}$$

Then

$$\dot{S} = \left. \frac{\partial f}{\partial x} \right|_{\text{nominal}} S + \left. \frac{\partial f}{\partial \lambda} \right|_{\text{nominal}}, \quad S(0) = 0$$

The augmented equation (3.7) is given by

$$\begin{aligned} \dot{x}_1 &= 0.5[-h(x_1) + x_2] \\ \dot{x}_2 &= 0.2(-x_1 - 1.5x_2 + 1.2) \\ \dot{x}_3 &= 0.5[-h'(x_1)x_3 + x_4] - 0.25[-h(x_1) + x_2] \\ \dot{x}_4 &= 0.2(-x_3 - 1.5x_4) \\ \dot{x}_5 &= 0.5[-h'(x_1)x_5 + x_6] \\ \dot{x}_6 &= 0.2(-x_5 - 1.5x_6) - 0.04(-x_1 - 1.5x_2 + 1.2) \end{aligned}$$

with the initial conditions

$$x_1(0) = x_{10}, \quad x_2(0) = x_{20}, \quad x_3(0) = x_4(0) = x_5(0) = x_6(0) = 0$$

## 《非线性系统（第三版）》习题解答

### • 3.11

$$\dot{x}_1 = x_2, \quad \dot{x}_2 = -x_1 + \varepsilon(1 - x_1^2)x_2$$

Denote the nominal values of  $\varepsilon$  by  $\varepsilon_0$ . The Jacobian matrices  $[\partial f/\partial x]$  and  $[\partial f/\partial \varepsilon]$ , are given by

$$\frac{\partial f}{\partial x} = \begin{bmatrix} 0 & 1 \\ -1 - 2\varepsilon x_1 x_2 & \varepsilon(1 - x_1^2) \end{bmatrix}, \quad \frac{\partial f}{\partial \varepsilon} = \begin{bmatrix} 0 \\ (1 - x_1^2)x_2 \end{bmatrix}$$

Let

$$S = \left. \frac{\partial x}{\partial \varepsilon} \right|_{\text{nominal}} = \begin{bmatrix} x_3 \\ x_4 \end{bmatrix}$$

Then

$$\dot{S} = \left. \frac{\partial f}{\partial x} \right|_{\text{nominal}} S + \left. \frac{\partial f}{\partial \varepsilon} \right|_{\text{nominal}}, \quad S(0) = 0$$

The augmented equation (3.7) is given by

$$\begin{aligned} \dot{x}_1 &= x_2 \\ \dot{x}_2 &= -x_1 + \varepsilon_0(1 - x_1^2)x_2 \\ \dot{x}_3 &= x_4 \\ \dot{x}_4 &= -[1 + 2\varepsilon_0 x_1 x_2]x_3 + \varepsilon_0(1 - x_1^2)x_4 + (1 - x_1^2)x_2 \end{aligned}$$

with the initial conditions

$$x_1(0) = x_{10}, \quad x_2(0) = x_{20}, \quad x_3(0) = x_4(0) = 0$$

### • 3.12

$$\dot{x}_1 = \frac{1}{\varepsilon}x_2, \quad \dot{x}_2 = -\varepsilon \left( x_1 - x_2 + \frac{1}{3}x_2^3 \right)$$

Denote the nominal values of  $\varepsilon$  by  $\varepsilon_0$ . The Jacobian matrices  $[\partial f/\partial x]$  and  $[\partial f/\partial \varepsilon]$ , are given by

$$\frac{\partial f}{\partial x} = \begin{bmatrix} 0 & \frac{1}{\varepsilon} \\ -\varepsilon & \varepsilon(1 - x_2^2) \end{bmatrix}, \quad \frac{\partial f}{\partial \varepsilon} = \begin{bmatrix} -\frac{1}{\varepsilon^2}x_2 \\ -(x_1 - x_2 + \frac{1}{3}x_2^3) \end{bmatrix}$$

Let

$$S = \left. \frac{\partial x}{\partial \varepsilon} \right|_{\text{nominal}} = \begin{bmatrix} x_3 \\ x_4 \end{bmatrix}$$

Then

$$\dot{S} = \left. \frac{\partial f}{\partial x} \right|_{\text{nominal}} S + \left. \frac{\partial f}{\partial \varepsilon} \right|_{\text{nominal}}, \quad S(0) = 0$$

The augmented equation (3.7) is given by

$$\begin{aligned} \dot{x}_1 &= \frac{1}{\varepsilon_0}x_2 \\ \dot{x}_2 &= -\varepsilon_0 \left( x_1 - x_2 + \frac{1}{3}x_2^3 \right) \\ \dot{x}_3 &= \frac{1}{\varepsilon_0}x_4 - \frac{1}{\varepsilon_0^2}x_2 \\ \dot{x}_4 &= -\varepsilon_0 x_3 + \varepsilon_0(1 - x_2^2)x_4 - \left( x_1 - x_2 + \frac{1}{3}x_2^3 \right) \end{aligned}$$

with the initial conditions

$$x_1(0) = x_{10}, \quad x_2(0) = x_{20}, \quad x_3(0) = x_4(0) = 0$$

## 《非线性系统（第三版）》习题解答

• 3.13

$$\dot{x}_1 = \tan^{-1}(ax_1) - x_1x_2, \quad \dot{x}_2 = bx_1^2 - cx_2$$

Let  $\lambda = [a, b, c]^T$ . The nominal values are  $a_0 = 1$ ,  $b_0 = 0$ , and  $c_0 = 1$ . The Jacobian matrices  $[\partial f/\partial x]$  and  $[\partial f/\partial \lambda]$ , are given by

$$\frac{\partial f}{\partial x} = \begin{bmatrix} \frac{a}{1+a^2x_1^2} - x_2 & -x_1 \\ 2bx_1 & -c \end{bmatrix}, \quad \frac{\partial f}{\partial \lambda} = \begin{bmatrix} \frac{x_1}{1+a^2x_1^2} & 0 & 0 \\ 0 & x_1^2 & -x_2 \end{bmatrix}$$

Let

$$S = \left. \frac{\partial x}{\partial \lambda} \right|_{\text{nominal}} = \begin{bmatrix} x_3 & x_5 & x_7 \\ x_4 & x_6 & x_8 \end{bmatrix}$$

Then

$$\dot{S} = \left. \frac{\partial f}{\partial x} \right|_{\text{nominal}} S + \left. \frac{\partial f}{\partial \lambda} \right|_{\text{nominal}}, \quad S(0) = 0$$

The augmented equation (3.7) is given by

$$\begin{aligned} \dot{x}_1 &= \tan^{-1}(x_1) - x_1x_2 \\ \dot{x}_2 &= -x_2 \\ \dot{x}_3 &= \left( \frac{1}{1+x_1^2} - x_2 \right) x_3 - x_1x_4 + \frac{x_1}{1+x_1^2} \\ \dot{x}_4 &= -x_4 \\ \dot{x}_5 &= \left( \frac{1}{1+x_1^2} - x_2 \right) x_5 - x_1x_6 \\ \dot{x}_6 &= -x_6 + x_1^2 \\ \dot{x}_7 &= \left( \frac{1}{1+x_1^2} - x_2 \right) x_7 - x_1x_8 \\ \dot{x}_8 &= -x_8 - x_2 \end{aligned}$$

with the initial conditions

$$x_1(0) = x_{10}, \quad x_2(0) = x_{20}, \quad x_3(0) = x_4(0) = x_5(0) = x_6(0) = x_7(0) = x_8(0) = 0$$

• 3.14 (a) Let  $p = \begin{bmatrix} \tau \\ \lambda \end{bmatrix}$  be the vector of parameters.

$$A = \frac{\partial f}{\partial x} = \begin{bmatrix} -(1/\tau) + \lambda/\cosh^2(\lambda x_1) & -\lambda/\cosh^2(\lambda x_2) \\ \lambda/\cosh^2(\lambda x_1) & -(1/\tau) + \lambda/\cosh^2(\lambda x_2) \end{bmatrix}$$

$$B = \frac{\partial f}{\partial p} = \begin{bmatrix} -(1/\tau^2)x_1 & x_1/\cosh^2(\lambda x_1) - x_2/\cosh^2(\lambda x_2) \\ -(1/\tau^2)x_2 & x_1/\cosh^2(\lambda x_1) + x_2/\cosh^2(\lambda x_2) \end{bmatrix}$$

The sensitivity equation is given by

$$\dot{S} = A_0S + B_0, \quad S(0) = 0$$

where  $A_0$  and  $B_0$  are evaluated at the nominal parameters. This equation should be solved simultaneously with the nominal state equation.

## 《非线性系统（第三版）》习题解答

(b)

$$\begin{aligned}
 r\dot{r} &= x_1\dot{x}_1 + x_2\dot{x}_2 \\
 &= -(1/\tau)r^2 + x_1[\tanh(\lambda x_1) - \tanh(\lambda x_2)] + x_2[\tanh(\lambda x_1) + \tanh(\lambda x_2)] \\
 &= -(1/\tau)r^2 + r \cos(\theta)[\tanh(\lambda x_1) - \tanh(\lambda x_2)] \\
 &\quad + r \sin(\theta)[\tanh(\lambda x_1) + \tanh(\lambda x_2)] \\
 &\leq -(1/\tau)r^2 + 2r(|\cos(\theta)| + |\sin(\theta)|) \\
 &\leq -(1/\tau)r^2 + 2\sqrt{2}r
 \end{aligned}$$

(c) By the comparison lemma,  $r(t) \leq u(t)$  where  $u$  satisfies the scalar differential equation

$$\dot{u} = -(1/\tau)u + 2\sqrt{2}, \quad u(0) = r(0) = \|x(0)\|_2$$

The solution of this differential equation is

$$\begin{aligned}
 u(t) &= \exp(-t/\tau)\|x(0)\|_2 + \int_0^t \exp[-(t-\sigma)/\tau]2\sqrt{2} d\sigma \\
 &= \exp(-t/\tau)\|x(0)\|_2 + 2\sqrt{2}\tau[1 - \exp(-t/\tau)]
 \end{aligned}$$

• 3.15 Let  $V = \|x\|_2^2 = x_1^2 + x_2^2$ . Then

$$\begin{aligned}
 \dot{V} &= 2x_1\dot{x}_1 + 2x_2\dot{x}_2 = -2x_1^2 - 2x_2^2 + \frac{4x_1x_2}{1+x_2^2} + \frac{4x_1x_2}{1+x_1^2} \\
 &\leq -2V + 4|x_1|\frac{|x_2|}{1+x_2^2} + 4|x_2|\frac{|x_1|}{1+x_1^2} \\
 &\leq -2V + 2|x_1| + 2|x_2| \quad \left(\text{since } \frac{|y|}{1+y^2} \leq \frac{1}{2}\right) \\
 &\leq -2V + 2\sqrt{2}\sqrt{V} \quad (\text{since } \|x\|_1 \leq \sqrt{2}\|x\|_2)
 \end{aligned}$$

Taking  $W = \sqrt{V} = \|x\|_2$ , we see that for  $V \neq 0$ ,

$$\dot{W} = \frac{\dot{V}}{2\sqrt{V}} \leq -W + \sqrt{2}$$

At  $V = 0$ , we have

$$\frac{|W(t+h) - W(t)|}{h} = \frac{|W(t+h)|}{h} = \frac{1}{h}\|x(t+h)\|_2$$

Similar to Example 3.9 of the textbook, it can be shown that

$$\lim_{h \rightarrow 0^+} \frac{1}{h} \int_t^{t+h} \|f(x(\tau))\|_2 d\tau = 0$$

Thus  $D^+W(t) \leq -W(t) + \sqrt{2}$  for all  $t \geq 0$ . Let  $u(t)$  be the solution of the differential equation

$$\dot{u} = -u + \sqrt{2}, \quad u(0) = \|x(0)\|_2$$

By the comparison lemma,

$$\|x(t)\|_2 \leq u(t) = e^{-t}\|x(0)\|_2 + \sqrt{2}(1 - e^{-t})$$

## 《非线性系统（第三版）》习题解答

- 3.16 Let  $v = x^2$ .

$$\dot{v} = 2x\dot{x} = -2x^2 + \frac{2x \sin t}{1+x^2} \leq -2v + 1$$

let  $u(t)$  be the solution of the differential equation

$$\dot{u} = -2u + 1, \quad u(0) = 2$$

Then

$$v(t) \leq u(t) = 2e^{-2t} + \int_0^t e^{-2(t-\tau)} d\tau = \frac{1+3e^{-2t}}{2}$$

Thus

$$|x(t)| = \sqrt{v(t)} \leq \sqrt{\frac{1+3e^{-2t}}{2}}$$

- 3.17 (a)

$$\frac{d}{dt} x^T x = 2x^T \dot{x} = 2x^T f(t, x)$$

$$\left| \frac{d}{dt} x^T x \right| \leq 2\|x\|_2 \|f(t, x)\|_2 \leq 2L\|x\|_2^2$$

(b) Let  $V(t) = x^T(t)x(t)$  and  $V_0 = x_0^T x_0$ , then from part (a) we have

$$-2LV(t) \leq \dot{V}(t) \leq 2LV(t)$$

Divide through by  $V(t)$ , multiply by  $dt$ , and integrate to obtain

$$-\int_{t_0}^t 2L dt \leq \int_{V_0}^V \frac{dV}{V} \leq \int_{t_0}^t 2L dt$$

$$-2L(t-t_0) \leq \ln \left( \frac{V(t)}{V_0} \right) \leq 2L(t-t_0)$$

$$V_0 \exp[-2L(t-t_0)] \leq V(t) \leq V_0 \exp[2L(t-t_0)]$$

Taking the square root yields

$$\|x_0\|_2 \exp[-L(t-t_0)] \leq \|x(t)\|_2 \leq \|x_0\|_2 \exp[L(t-t_0)]$$

- 3.18 Let  $z(t) = y(t)e^{\alpha(t-t_0)}$ . Then

$$\begin{aligned} z(t) &\leq k_1 + \int_{t_0}^t e^{\alpha(\tau-t_0)} [k_2 y(\tau) + k_3] d\tau = k_1 + \int_{t_0}^t [k_2 z(\tau) + k_3 e^{\alpha(\tau-t_0)}] d\tau \\ &= k_1 + k_2 \int_{t_0}^t z(\tau) d\tau + (k_3/\alpha) [\exp^{\alpha(t-t_0)} - 1] \end{aligned}$$

From Gronwall-Bellman inequality,

$$z(t) \leq k_1 + (k_3/\alpha) [\exp^{\alpha(t-t_0)} - 1] + \int_{t_0}^t \left\{ k_1 + (k_3/\alpha) [\exp^{\alpha(s-t_0)} - 1] \right\} k_2 e^{k_2(t-s)} ds$$

By evaluating the integral, it can be shown that

$$z(t) \leq \frac{k_3}{\alpha} e^{\alpha(t-t_0)} + \left( k_1 - \frac{k_3}{\alpha} \right) e^{k_2(t-t_0)} + \frac{k_2 k_3}{\alpha(\alpha - k_2)} [e^{\alpha(t-t_0)} - e^{k_2(t-t_0)}]$$

## 《非线性系统（第三版）》习题解答

Hence

$$\begin{aligned}
 y(t) &= z(t)e^{-\alpha(t-t_0)} \leq \frac{k_3}{\alpha} \left[ 1 + \frac{k_2}{(\alpha - k_2)} \right] + \left[ k_1 - \frac{k_3}{\alpha} - \frac{k_2 k_3}{\alpha(\alpha - k_2)} \right] e^{(k_2 - \alpha)(t-t_0)} \\
 &= \frac{k_3}{(\alpha - k_2)} + \left[ k_1 - \frac{k_3}{(\alpha - k_2)} \right] e^{(k_2 - \alpha)(t-t_0)} \\
 &= k_1 e^{-(\alpha - k_2)(t-t_0)} + \frac{k_3}{(\alpha - k_2)} \left[ 1 - e^{-(\alpha - k_2)(t-t_0)} \right]
 \end{aligned}$$

• 3.19 Choose the covering of  $S$  as described in the hint. Within each neighborhood we have

$$\|f(x) - f(y)\| \leq L_i \|x - y\|, \quad \forall x, y \in N(a_i, r_i)$$

If  $x, y \in S \cap N(a_i, r_i)$  for some  $i$ , then the Lipschitz condition holds with  $L = L_i$ . Otherwise,  $\|x - y\| \geq \min_i r_i$ . Since  $f(x)$  is uniformly bounded on  $S$ , we have

$$\|f(x) - f(y)\| \leq C, \quad \forall x, y \in S, \quad C > 0$$

Therefore, whenever  $\|x - y\| \geq \min_i r_i$ , we have

$$\|f(x) - f(y)\| \leq \frac{C}{\min_i r_i} \|x - y\|$$

Take

$$L = \max \left\{ L_1, L_2, \dots, L_k, \frac{C}{\min_i r_i} \right\}$$

• 3.20 We have

$$\|f(x) - f(y)\| \leq L \|x - y\|, \quad \forall x, y \in W$$

Given  $\varepsilon > 0$ , let  $\delta = \varepsilon/L$ . For all  $\|x - y\| < \delta$ , we have  $\|f(x) - f(y)\| < L\delta = \varepsilon$ , which implies uniform continuity.

• 3.21 The vector  $y$  is defined only for  $x \neq 0$ . For  $x = 0$ , we can take  $y$  as any vector with  $\|y\|_q = 1$ . Now, for  $x \neq 0$  we have

$$y^T x = \sum_{i=1}^n y_i x_i = \sum_{i=1}^n \frac{x_i^p \operatorname{sign}(x_i^p)}{\|x\|_p^{p-1}} = \frac{1}{\|x\|_p^{p-1}} \sum_{i=1}^n |x_i|^p = \frac{\|x\|_p^p}{\|x\|_p^{p-1}} = \|x\|_p$$

$$\|y\|_q^q = \sum_i |y_i|^q = \frac{1}{\|x\|_p^{q(p-q)}} \sum_{i=1}^n |x_i|^{pq-p} = \frac{1}{\|x\|_p^p} \sum_{i=1}^n |x_i|^p = 1$$

For  $p = \infty$ , take

$$y_i = \begin{cases} 1, & \text{if } i = \arg \max |x_i| \\ 0 & \text{otherwise} \end{cases}$$

Then,  $y^T x = \|x\|_\infty$  and  $\|y\|_1 = 1$ .

• 3.22 If

$$\left\| \frac{\partial f}{\partial x}(t, x) \right\| \leq L, \quad \forall (t, x) \in [a, b] \times \mathbb{R}^n$$

then, from Lemma 3.1,

$$\|f(t, y) - f(t, x)\| \leq L \|x - y\|, \quad \forall (t, x) \in [a, b] \times \mathbb{R}^n$$

## 《非线性系统（第三版）》习题解答

Alternatively, suppose  $f(t, x)$  is globally Lipschitz. By the mean value theorem

$$f_i(t, y) - f_i(t, x) = \frac{\partial f_i}{\partial x}(t, z) (y - x)$$

where  $z = \alpha x + (1 - \alpha)y$  and  $0 < \alpha < 1$ . Then

$$\left\| \frac{\partial f_i}{\partial x}(t, z) (y - x) \right\| = \|f_i(t, y) - f_i(t, x)\| \leq L_i \|y - x\|, \quad \forall x, y \in R^n, \forall t \in [a, b]$$

Hence

$$\left\| \frac{\frac{\partial f_i}{\partial x}(t, z) (y - x)}{\|y - x\|} \right\| \leq L_i, \quad \forall x, y \in R^n, \forall t \in [a, b]$$

Taking  $y = \beta x$  with  $\beta > 1$ , we have  $z = [\alpha + (1 - \alpha)\beta]x \stackrel{\text{def}}{=} \gamma x$ , and

$$\left\| \frac{\frac{\partial f_i}{\partial x}(t, \gamma x) (\beta - 1)x}{(\beta - 1)\|x\|} \right\| \leq L_i, \quad \forall x \in R^n, \forall t \in [a, b]$$

Thus

$$\left\| \frac{\frac{\partial f_i}{\partial x}(t, \gamma x) x}{\|x\|} \right\| \leq L_i, \quad \forall x \in R^n, \forall t \in [a, b]$$

By letting  $\beta$  approach 1, we conclude that

$$\left\| \frac{\frac{\partial f_i}{\partial x}(t, x) x}{\|x\|} \right\| \leq L_i, \quad \forall x \in R^n, \forall t \in [a, b]$$

which shows that

$$\left\| \frac{\partial f_i}{\partial x}(t, x) \right\| \leq L_i, \quad \forall x \in R^n, \forall t \in [a, b]$$

Since this inequality holds for every  $1 \leq i \leq n$ , we conclude that the Jacobian matrix  $[\partial f / \partial x]$  is globally bounded.

• 3.23 Set  $g(\sigma) = f(\sigma x)$  for  $0 \leq \sigma \leq 1$ . Since  $D$  is convex,  $\sigma x \in D$  for  $0 \leq \sigma \leq 1$ .

$$g'(\sigma) = \frac{\partial f}{\partial x}(\sigma x) \frac{\partial \sigma x}{\partial \sigma} = \frac{\partial f}{\partial x}(\sigma x) x$$

$$f(x) - f(0) = g(1) - g(0) = \int_0^1 g'(\sigma) d\sigma = \int_0^1 \frac{\partial f}{\partial x}(\sigma x) d\sigma x$$

• 3.24 (a)

$$V(t, x) = \int_0^1 \frac{\partial V}{\partial x}(t, \sigma x) d\sigma x \leq \int_0^1 \left\| \frac{\partial V}{\partial x}(t, \sigma x) \right\| \|x\| d\sigma \leq \int_0^1 c_4 \sigma d\sigma \|x\|^2 \leq \frac{1}{2} c_4 \|x\|^2$$

(b) Since

$$c_1 \|x\|^2 \leq V(t, x) \leq \frac{1}{2} c_4 \|x\|^2, \quad \forall x \in D$$

we must have  $c_1 \leq \frac{1}{2} c_4$ .

(c) Consider two points  $x_1$  and  $x_2$  such that  $\alpha x_1 + (1 - \alpha)x_2 \neq 0$  for all  $0 \leq \alpha \leq 1$ ; that is, the origin does



## 《非线性系统（第三版）》习题解答

not lie on the line connecting  $x_1$  and  $x_2$ . The Jacobian  $[\partial W/\partial x]$  is defined for every  $x = \alpha x_1 + (1 - \alpha)x_2$  and given by

$$\frac{\partial W}{\partial x}(t, x) = \frac{1}{2\sqrt{V(t, x)}} \frac{\partial V}{\partial x}(t, x)$$

By the mean value theorem, there is  $\alpha^* \in (0, 1)$  such that, with  $z = \alpha^* x_1 + (1 - \alpha^*)x_2$ ,

$$W(t, x_2) - W(t, x_1) = \frac{\partial W}{\partial x}(t, z) (x_2 - x_1) = \frac{1}{2\sqrt{V(t, z)}} \frac{\partial V}{\partial x}(t, z) (x_2 - x_1)$$

Hence

$$|W(t, x_2) - W(t, x_1)| \leq \frac{1}{2\sqrt{c_1} \|z\|} c_4 \|z\| \|x_2 - x_1\| \leq \frac{c_4}{2\sqrt{c_1}} \|x_2 - x_1\|$$

Consider now the case when the origin lies on the line connecting  $x_1$  and  $x_2$ ; that is,  $0 = \alpha_0 x_1 + (1 - \alpha_0)x_2$  for some  $\alpha_0 \in [0, 1]$ . We have

$$|W(t, x_2) - W(t, 0)| = |W(t, x_2)| = \sqrt{V(t, x_2)} \leq \sqrt{\frac{c_4}{2}} \|x_2\|$$

$$|W(t, x_1) - W(t, 0)| = |W(t, x_1)| = \sqrt{V(t, x_1)} \leq \sqrt{\frac{c_4}{2}} \|x_1\|$$

$$|W(t, x_2) - W(t, x_1)| = |W(t, x_2) - W(t, 0) + W(t, 0) - W(t, x_1)| \leq \sqrt{\frac{c_4}{2}} (\|x_2\| + \|x_1\|)$$

Since the origin lies on the line connecting  $x_1$  and  $x_2$ , we have  $\|x_2\| + \|x_1\| = \|x_2 - x_1\|$ . We also have  $1 \leq \sqrt{c_4/2c_1}$ . Therefore,

$$|W(t, x_2) - W(t, x_1)| \leq \frac{c_4}{2\sqrt{c_1}} \|x_2 - x_1\|$$

Thus, the preceding inequality is satisfied for all  $x_1, x_2 \in D$ .

### • 3.25

(a)

$$x(t) = x(\alpha) + \int_{\alpha}^t f(\tau, x(\tau)) d\tau, \quad \forall [\alpha, t] \subset [t_0, T]$$

Since  $f(t, x)$  is piecewise continuous in  $t$  and continuous in  $x$ , there exists a constant  $M > 0$  such that  $\|f(t, x(t))\| \leq M$  for all  $t \in [t_0, T]$ . Therefore

$$\|x(t) - x(\alpha)\| = \left\| \int_{\alpha}^t f(\tau, x(\tau)) d\tau \right\| \leq \int_{\alpha}^t M d\tau = M(t - \alpha)$$

which shows that  $x(t)$  is uniformly continuous on  $[t_0, T]$ .

(b)

$$x(T) = x(t_0) + \lim_{t \rightarrow T} \int_{t_0}^t f(\tau, x(\tau)) d\tau = x(t_0) + \int_{t_0}^T f(\tau, x(\tau)) d\tau$$

since  $x(t)$  is uniformly continuous. Thus

$$x(t) = x(t_0) + \int_{t_0}^t f(\tau, x(\tau)) d\tau, \quad \forall t \in [t_0, T]$$

is a solution on  $[t_0, T]$ . Since  $W$  is closed,  $x(T) \in W$ .

(c) Apply the local existence and uniqueness theorem at  $(T, x(T))$ .

## 《非线性系统（第三版）》习题解答

• 3.26 Suppose there is no such  $t$ . Then,  $y(t) \in W$  for all  $t \in [t_0, T)$ . From the previous exercise we can extend the solution beyond  $T$ , which contradicts the claim that  $[t_0, T)$  is the maximal interval of existence.

• 3.27 Set  $y(t) = x_1(t) - x_2(t)$  and  $\mu = \mu_1 + \mu_2$ .

$$\begin{aligned}
 \|\dot{y}(t)\| &= \|\dot{x}_1(t) - \dot{x}_2(t)\| \\
 &= \|\dot{x}_1(t) - f_1(t, x_1(t)) - \dot{x}_2(t) + f_2(t, x_2(t)) + f_1(t, x_1(t)) - f_2(t, x_2(t))\| \\
 &\leq \mu_1 + \mu_2 + L\|x_1(t) - x_2(t)\| = \mu + \|y(t)\|
 \end{aligned}$$

$$\begin{aligned}
 \|y(t)\| &= \|y(t_0) + \int_{t_0}^t \dot{y}(s) ds\| \leq \gamma + \int_{t_0}^t \|\dot{y}(s)\| ds \\
 &\leq \gamma + \mu(t - a) + \int_a^t L\|y(s)\| ds
 \end{aligned}$$

Application of Gronwall-Bellman inequality yields

$$\|y(t)\| \leq \gamma + \mu(t - a) + \int_a^t [\gamma + \mu(s - a)] L e^{\int_s^t L d\tau} ds$$

After integrating the right-hand side by parts, we obtain

$$\|y(t)\| \leq \gamma e^{L(t-a)} + \frac{\mu}{L} [e^{L(t-a)} - 1]$$

• 3.28 Let

$$x(t) = x_0 + \int_{t_0}^t f(s, x(s)) ds, \quad y(t) = x_0 + \int_{t_0}^t f(s, y(s)) ds$$

where  $t_0' \geq t_0$ . Then

$$x(t) - y(t) = \int_{t_0}^{t_0'} f(s, x(s)) ds + \int_{t_0'}^t [f(s, y(s)) - f(s, x(s))] ds$$

We have  $\|f(s, x(s))\| \leq M$  for all  $t \in [t_0, t_1]$ , and  $\|f(s, y) - f(s, x)\| \leq L\|x - y\|$ . Therefore

$$\|x(t) - y(t)\| \leq M(t_0' - t_0) + \int_{t_0'}^t L\|x(s) - y(s)\| ds$$

By Gronwall-Bellman inequality

$$\|x(t) - y(t)\| \leq M(t_0' - t_0)e^{L(t-t_0)}$$

Hence, over any compact interval of time, we have

$$\|x(t) - y(t)\| \leq K(t_0' - t_0)$$

• 3.29

$$\dot{x} = f(t, x), \quad x(t_0) = \eta$$

Setting  $y = x - \eta$ , we obtain

$$\dot{y} = f(t, y + \eta), \quad y(t_0) = 0$$

Since  $f$  is continuously differentiable in  $x$ , the solution will be continuously differentiable in  $\eta$ . Let

$$y_\eta(t, \eta) = \frac{\partial y(t, \eta)}{\partial \eta} = \frac{\partial x(t, \eta)}{\partial \eta} - I = x_\eta(t, \eta) - I$$

## 《非线性系统（第三版）》习题解答

From (3.4)

$$\frac{\partial}{\partial t} y_\eta(t, \eta) = A(t, \eta) y_\eta(t, \eta) + B(t, \eta), \quad y_\eta(t_0, \eta) = 0$$

where

$$\begin{aligned}
 A(t, \eta) &= \frac{\partial f}{\partial y}(t, y(t, \eta) + \eta) = \frac{\partial f}{\partial x}(t, x(t, \eta)) \\
 B(t, \eta) &= \frac{\partial f}{\partial \eta}(t, y(t, \eta) + \eta) = \frac{\partial f}{\partial x}(t, x(t, \eta)) = A(t, \eta)
 \end{aligned}$$

Thus,  $x_\eta(t, \eta)$  satisfies the variational equation

$$\frac{\partial}{\partial t} x_\eta(t, \eta) = A(t, \eta) x_\eta(t, \eta), \quad x_\eta(t_0, \eta) = I$$

• 3.30

$$x(t, a, \eta) = \eta + \int_a^t f(s, x(s, a, \eta)) ds$$

$$\begin{aligned}
 x_a(t) &= \frac{\partial}{\partial a} x(t, a, \eta) = -f(a, \eta) + \int_a^t \frac{\partial f}{\partial x}(s, x(s, a, \eta)) \frac{\partial}{\partial a} x(s, a, \eta) ds \\
 x_\eta(t) &= \frac{\partial}{\partial \eta} x(t, a, \eta) = I + \int_a^t \frac{\partial f}{\partial x}(s, x(s, a, \eta)) \frac{\partial}{\partial \eta} x(s, a, \eta) ds
 \end{aligned}$$

Therefore

$$x_a(t) + x_\eta(t) f(a, \eta) = \int_a^t \left\{ \frac{\partial f}{\partial x}(s, x(s, a, \eta)) [x_a(s) + x_\eta(s) f(a, \eta)] \right\} ds$$

Differentiating with respect to  $t$ , we see that  $x_a(t) + x_\eta(t) f(a, \eta)$  satisfies the differential equation

$$\frac{\partial}{\partial t} [x_a(t) + x_\eta(t) f(a, \eta)] = \frac{\partial f}{\partial x}(t, x(t, a, \eta)) [x_a(t) + x_\eta(t) f(a, \eta)]$$

with initial condition

$$x_a(a) + x_\eta(a) f(a, \eta) = -f(a, \eta) + f(a, \eta) = 0$$

Thus

$$x_a(t) + x_\eta(t) f(a, \eta) \equiv 0, \quad \forall t \in [a, t_1]$$

• 3.31 Put

$$z(t) = x(a) + \int_a^t f(s, y(s)) ds$$

so that  $z(a) = x(a)$  and  $z(t) \leq y(t)$  for  $a \leq t \leq b$ .

$$\dot{z} = f(t, y(t)) \leq f(t, z(t))$$

From the comparison lemma, we conclude that

$$z(t) \leq x(t) \Rightarrow y(t) \leq x(t), \quad \forall a \leq t \leq b$$

## 《非线性系统（第三版）》习题解答

---

Controlengineers.ir

## 《非线性系统（第三版）习题解答

# Chapter 4

• 4.1

- (1) asymptotically stable    (2) unstable    (3) asymptotically stable  
 (4) unstable    (5) stable    (6) unstable

• 4.2 Let  $f(x) = ax^p + g(x)$ . Near the origin, the term  $ax^p$  is dominant. Hence,  $\text{sign}(f(x)) = \text{sign}(ax^p)$ . Consider the case when  $a < 0$  and  $p$  is odd. With  $V(x) = \frac{1}{2}x^2$  as a Lyapunov function candidate, we have

$$\dot{V} = x[ax^p + g(x)] \leq ax^{p+1} + k|x|^{p+2}$$

Near the origin, the term  $ax^{p+1}$  is dominant. Hence,  $\dot{V}(x)$  is negative definite and the origin is asymptotically stable. Consider now the case when  $a > 0$  and  $p$  is odd. In the neighborhood of the origin,  $\text{sign}(f(x)) = \text{sign}(x)$ . Hence, a trajectory starting near  $x = 0$  will be always moving away from  $x = 0$ . This shows that the origin is unstable. When  $p$  is even, a similar behavior will take place on one side of the origin; namely, on the side  $x > 0$  when  $a > 0$  and  $x < 0$  when  $a < 0$ . Therefore, the origin is unstable.

• 4.3 (1) Let  $V(x) = (1/2)(x_1^2 + x_2^2)$ .

$$\dot{V} = x_1(-x_1 + x_1x_2) - x_2^2$$

In the set  $\{\|x\|_2 \leq r^2\}$ , we have  $|x_1| \leq r$ . Hence,

$$\dot{V} \leq -x_1^2 - x_2^2 + r|x_1||x_2| = - \begin{bmatrix} |x_1| \\ |x_2| \end{bmatrix}^T \begin{bmatrix} 1 & -r/2 \\ -r/2 & 1 \end{bmatrix} \begin{bmatrix} |x_1| \\ |x_2| \end{bmatrix}$$

$\dot{V}$  is negative definite for  $r < 2$ . Thus, the origin is asymptotically stable. To investigate global asymptotic stability, note that the solution of the second equation is  $x_2(t) = \exp(-t)x_2(0)$ , which when substituted in the first equation yields

$$\dot{x}_1 = [-1 + \exp(-t)x_2(0)]x_1$$

This is a linear time-varying system whose solution does not have a finite escape time. After some finite time the coefficient of  $x_1$  on the right-hand side will be less than a negative number. Hence,  $\lim_{t \rightarrow \infty} x_1(t) = 0$ . Thus, the origin is globally asymptotically stable.

(2) Let  $V(x) = (1/2)(x_1^2 + x_2^2)$ .

$$\dot{V} = -(x_1^2 + x_2^2)(1 - x_1^2 - x_2^2) = -2V(1 - 2V)$$

In the region  $V(x) < 1/2$ ,  $\dot{V}$  is negative definite. Hence, the origin is asymptotically stable. For  $V > 1/2$ ,  $\dot{V}$  is positive. Hence, trajectories starting in the region  $V(x) > 1/2$  cannot approach the origin. In fact, they grow unbounded. Thus, the origin is not globally asymptotically stable.

(3) Let  $V(x) = x^T P x = p_{11}x_1^2 + 2p_{12}x_1x_2 + p_{22}x_2^2$ , where  $P$  is a positive definite symmetric matrix.

$$\dot{V} = -2p_{12}x_1^2 + 2(p_{11} - p_{12} - p_{22})x_1x_2 - 2(p_{22} - p_{12})x_2^2 + \text{Higher order terms}$$

## 《非线性系统（第三版）》习题解答

Near the origin, the quadratic term dominates the higher-order terms. Thus,  $\dot{V}$  will be negative definite in the neighborhood of the origin if the quadratic term is negative definite. Choosing  $p_{12} = 1$ ,  $p_{22} = 2$ , and  $p_{11} = 3$  makes  $V(x)$  positive definite and  $\dot{V}(x)$  negative definite. Hence, the origin is asymptotically stable. It is not globally asymptotically stable since the origin is not the unique equilibrium point. The set  $\{x_1^2 = 1\}$  is an equilibrium set.

(4) Let  $V(x) = x_1^2 + (1/2)x_2^2$ .

$$\dot{V} = -2x_1^2 - 2x_1x_2 + 2x_1x_2 - x_2^4 = -x_1^2 - x_2^4$$

Hence, the origin is globally asymptotically stable.

• 4.4 (a) Take  $V(\omega) = (1/2)(J_1\omega_1^2 + J_2\omega_2^2 + J_3\omega_3^2)$  as a Lyapunov function candidate.

$$\begin{aligned}\dot{V} &= J_1\omega_1\dot{\omega}_1 + J_2\omega_2\dot{\omega}_2 + J_3\omega_3\dot{\omega}_3 \\ &= (J_2 - J_3)\omega_1\omega_2\omega_3 + (J_3 - J_1)\omega_1\omega_2\omega_3 + (J_1 - J_2)\omega_1\omega_2\omega_3 \\ &= 0\end{aligned}$$

The origin is stable. It is not asymptotically stable since  $\dot{V}$  is identically zero.

(b) The closed-loop state equation is

$$\begin{aligned}J_1\dot{\omega}_1 &= (J_2 - J_3)\omega_2\omega_3 - k_1\omega_1 \\ J_2\dot{\omega}_2 &= (J_3 - J_1)\omega_3\omega_1 - k_2\omega_2 \\ J_3\dot{\omega}_3 &= (J_1 - J_2)\omega_1\omega_2 - k_3\omega_3\end{aligned}$$

Using the same function  $V(\omega)$  as in part (a), we obtain

$$\dot{V} = -k_1\omega_1^2 - k_2\omega_2^2 - k_3\omega_3^2$$

Thus, the origin is globally asymptotically stable.

• 4.5 Let  $g(x) = \nabla V$ ;  $g_i(x) = \partial V / \partial x_i$ .

$$\frac{\partial g_i}{\partial x_j} = \frac{\partial}{\partial x_j} \frac{\partial V}{\partial x_i} = \frac{\partial^2 V}{\partial x_j \partial x_i}$$

Similarly

$$\frac{\partial g_j}{\partial x_i} = \frac{\partial}{\partial x_i} \frac{\partial V}{\partial x_j} = \frac{\partial^2 V}{\partial x_i \partial x_j}$$

Hence

$$\frac{\partial g_i}{\partial x_j} = \frac{\partial g_j}{\partial x_i}$$

Alternatively, suppose

$$\frac{\partial g_i}{\partial x_j} = \frac{\partial g_j}{\partial x_i}, \quad \forall i, j = 1, \dots, n$$

Define

$$\begin{aligned}V(x) &= \int_0^{x_1} g_1(y_1, 0, \dots, 0) dy_1 + \int_0^{x_2} g_2(x_1, y_2, 0, \dots, 0) dy_2 \\ &+ \dots + \int_0^{x_n} g_n(x_1, x_2, \dots, x_{n-1}, y_n) dy_n\end{aligned}$$

## 《非线性系统（第三版）》习题解答

$$\begin{aligned}
 \frac{\partial V}{\partial x_1} &= g_1(x_1, 0, \dots, 0) + \int_0^{x_2} \frac{\partial g_2}{\partial x_1}(x_1, y_2, 0, \dots, 0) dy_2 \\
 &\quad + \dots + \int_0^{x_n} \frac{\partial g_n}{\partial x_1}(x_1, x_2, \dots, x_{n-1}, y_n) dy_n \\
 &= g_1(x_1, 0, \dots, 0) + \int_0^{x_2} \frac{\partial g_1}{\partial y_2}(x_1, y_2, 0, \dots, 0) dy_2 \\
 &\quad + \dots + \int_0^{x_n} \frac{\partial g_1}{\partial y_n}(x_1, x_2, \dots, x_{n-1}, y_n) dy_n \\
 &= g_1(x_1, 0, \dots, 0) + g_1(x_1, y_2, 0, \dots, 0)|_0^{x_2} \\
 &\quad + \dots + g_1(x_1, x_2, \dots, x_{n-1}, y_n)|_0^{x_n} \\
 &= g_1(x)
 \end{aligned}$$

Similarly, it can be shown that

$$\frac{\partial V}{\partial x_i} = g_i(x), \quad \forall i$$

• 4.6 Try

$$g(x) = \begin{bmatrix} \alpha x_1 + \beta x_2 \\ \gamma x_1 + \delta x_2 \end{bmatrix}$$

To meet the symmetry requirement, take  $\gamma = \beta$ .

$$\dot{V}(x) = (\alpha x_1 + \beta x_2)x_2 - (\beta x_1 + \delta x_2)[(x_1 + x_2) + h(x_1 + x_2)]$$

Take  $\delta = \beta$ .

$$\dot{V}(x) = -\beta x_1^2 + (\alpha - 2\beta)x_1 x_2 - \beta(x_1 + x_2)h(x_1 + x_2)$$

Taking  $\alpha = 2\beta$  and  $\beta > 0$  yields

$$\dot{V}(x) = -\beta x_1^2 - \beta(x_1 + x_2)h(x_1 + x_2)$$

which is negative definite for all  $x \in \mathbb{R}^2$ . Now

$$g(x) = \beta \begin{bmatrix} 2 & 1 \\ 1 & 1 \end{bmatrix} x \stackrel{\text{def}}{=} Px \Rightarrow V(x) = \int_0^x g^T(y) dy = \frac{1}{2} x^T Px$$

where  $P$  is positive definite. Thus,  $V(x)$  is a radially unbounded Lyapunov function and the origin is globally asymptotically stable.

• 4.7 (a) Let  $\nabla V(x) = g(x)$ . Then,  $\dot{V} = -g^T(x)Q\phi(x)$ . Choose  $g(x) = Px$  so that  $V(x) = (1/2)x^T Px$ . We need to choose  $P = P^T > 0$  such that  $\dot{V} = -x^T P Q \phi(x)$  is negative definite. Choosing  $P = Q^{-1}$  yields

$$\dot{V} = -x^T \phi(x) = -\sum_{i=1}^n x_i \phi_i(x_i)$$

$\dot{V}$  is negative definite in the neighborhood of the origin because  $y\phi(y) > 0$  for  $y \neq 0$ . Hence, the origin is asymptotically stable.

(b) The function  $V(x)$  is radially unbounded. The origin will be globally asymptotically stable if  $\dot{V}$  is negative definite for all  $x$ . This will be the case if  $y\phi_i(y) > 0$  for all  $y \neq 0$ .

(c) The function  $\phi_2$  satisfies the condition  $y\phi_i(y) > 0$  for all  $y \neq 0$ . The function  $\phi_1$  satisfies the condition only near  $y = 0$  because  $\phi_1(y)$  vanishes at  $y = 1$ . Thus, we can only show asymptotic stability of the origin using the Lyapunov function  $V(x) = x^T Q^{-1} x = x_1^2 + 2x_1 x_2 + 2x_2^2$ .

## 《非线性系统（第三版）》习题解答

• 4.8

(a)  $V(0) = 0$  and  $V(x) > 0$  for  $x \neq 0$ .

$$\begin{aligned}
 \dot{V}(x) &= \frac{2x_1(1+x_1^2) - 2x_1^3}{(1+x_1^2)^2} \dot{x}_1 + 2x_2 \dot{x}_2 \\
 &= \frac{2x_1}{u^2} \left[ \frac{-6x_1}{u^2} + 2x_2 \right] - \frac{4x_2(x_1+x_2)}{u^2} \\
 &= -\frac{12x_1^2}{u^4} - \frac{4x_2^2}{u^2} < 0, \quad \forall x \in \mathbb{R}^2, x \neq 0.
 \end{aligned}$$

(b) The slope of the tangents to the hyperbola is given by

$$\frac{dx_2}{dx_1} = \frac{-2}{(x_1 - \sqrt{2})^2} = \frac{-1}{\frac{1}{2}x_1^2 - \sqrt{2}x_1 + 1}$$

On the other hand,

$$\begin{aligned}
 \left. \frac{f_2}{f_1} \right|_{\text{hyperbola}} &= \left. \frac{-2(x_1+x_2)}{-6x_1+2x_2(1+x_1^2)} \right|_{x_2=\frac{2}{x_1-\sqrt{2}}} \\
 &= \frac{-1}{2x_1^2+2\sqrt{2}x_1+1}
 \end{aligned}$$

For  $x_1 > \sqrt{2}$

$$2x_1^2 + 2\sqrt{2}x_1 + 1 > \frac{1}{2}x_1^2 - \sqrt{2}x_1 + 1$$

Hence

$$\left. \frac{f_2}{f_1} \right|_{\text{hyperbola}} > \text{slope of tangents}$$

Moreover

$$\left. f_1 \right|_{\text{hyperbola}} = \frac{-6x_1}{u^2} + \frac{4}{x_1 - \sqrt{2}} = \frac{4 + 6\sqrt{2}x_1 + 2x_1^2 + 4x_1^4}{u^2(x_1 - \sqrt{2})} > 0$$

Hence, the vector field on the branch of the hyperbola in the first quadrant always points to the right of the hyperbola.

(c) Since trajectories starting to the right of the hyperbola do not reach the origin, the origin is not globally asymptotically stable.

• 4.9 (a)

$$x_1 = 0 \Rightarrow V(x) = \frac{x_2^2}{1+x_2^2} + x_2^2 \rightarrow \infty \text{ as } |x_2| \rightarrow \infty$$

$$x_2 = 0 \Rightarrow V(x) = \frac{x_1^2}{1+x_1^2} + x_1^2 \rightarrow \infty \text{ as } |x_1| \rightarrow \infty$$

(b) On the line  $x_2 = x_1$ , we have

$$V(x) = \frac{4x_1^2}{1+4x_1^2} \rightarrow 1 \text{ as } |x_1| \rightarrow \infty$$

• 4.10 (a)

$$\begin{aligned}
 x^T P f(x) + f^T(x) P x &= x^T P \int_0^1 \frac{\partial f}{\partial x}(\sigma x) x d\sigma + \int_0^1 x^T \left[ \frac{\partial f}{\partial x}(\sigma x) \right]^T d\sigma P x \\
 &= x^T \int_0^1 \left\{ P \frac{\partial f}{\partial x}(\sigma x) + \left[ \frac{\partial f}{\partial x}(\sigma x) \right]^T P \right\} d\sigma x \leq -x^T x
 \end{aligned}$$



## 《非线性系统（第三版）》习题解答

(b)  $V(x) = f^T(x)Pf(x)$  is positive semidefinite. To show that it is positive definite, we need to show that  $V = 0 \Leftrightarrow x = 0$ . Since  $P$  is positive definite, we need to show that  $f(x) = 0$  if and only if  $x = 0$ ; that is, the origin is the unique equilibrium point. Suppose, to the contrary, that there is  $p \neq 0$  such that  $f(p) = 0$ . Then,

$$p^T p \leq -[p^T P f(p) + f^T(p) P p] = 0 \Rightarrow p = 0$$

which is a contradiction. Hence, the origin is the unique equilibrium point. To show that  $V$  is radially unbounded, we note that for any  $x \in R^n$

$$\frac{x^T P f(x)}{\|x\|_2^2} = \frac{1}{2\|x\|_2^2} [x^T P f(x) + f^T(x) P x] \leq -\frac{1}{2}, \quad \forall x \in R^n$$

Suppose now that  $\|f(x)\|_2 \leq c$  as  $\|x\|_2 \rightarrow \infty$ . Then

$$\frac{\|x^T P f(x)\|_2}{\|x\|_2^2} \leq \frac{\|x^T\|_2 \|P\|_2 c}{\|x\|_2^2} \leq \frac{\|P\|_2 c}{\|x\|_2} \rightarrow 0 \text{ as } \|x\|_2 \rightarrow \infty$$

But this is a contradiction since

$$\frac{x^T P f(x)}{\|x\|_2^2} \leq -\frac{1}{2}, \quad \forall x \in R^n$$

Thus, as  $\|x\|_2 \rightarrow \infty$ , the magnitude of at least one component of  $f(x)$  must approach  $\infty$ . This shows that  $V(x) \rightarrow \infty$  as  $\|x\|_2 \rightarrow \infty$ .

(c) We have shown that  $V(x)$  is positive definite and radially unbounded.

$$\dot{V}(x) = f^T(x) \left\{ P \left[ \frac{\partial f}{\partial x}(x) \right] + \left[ \frac{\partial f}{\partial x}(x) \right]^T P \right\} f(x) \leq -\|f(x)\|_2^2$$

Since  $f(x) = 0 \Leftrightarrow x = 0$ ,  $\dot{V}(x) < 0$ , for all  $x \in R^n$ ,  $x \neq 0$ . Thus, the origin is globally asymptotically stable.

• 4.11 Since  $V_1(x)$  is not negative semidefinite, there exists a point  $x_0$  arbitrarily close to the origin such that  $V_1(x_0) > 0$ . Let  $U = \{x \in B_r \mid V_1(x) > 0\}$ , where  $B_r \subset D$ . Since  $\dot{V}_1(x)$  is positive definite, we have  $\dot{V}_1(x) > 0$  for all  $x \in U$ . Hence, the origin is unstable.

• 4.12 Since  $V_1(x)$  is not negative semidefinite, there exists a point  $x_0$  arbitrarily close to the origin such that  $V_1(x_0) > 0$ . Let  $U = \{x \in B_r \mid V_1(x) > 0\}$ , where  $B_r \subset D$ . Since  $W(x) \geq 0$  for all  $x \in D$ , we have

$$\dot{V}_1(x) = W(x) + \lambda V_1(x) > 0, \quad \forall x \in U$$

Hence, the origin is unstable.

• 4.13 (1) Apply Chetaev's theorem with  $V(x) = (1/2)(x_1^2 - x_2^2)$ . The function  $V$  is positive at points arbitrarily close to the origin on the  $x_1$ -axis.

$$\begin{aligned} \dot{V}(x) &= x_1(x_1^3 + x_1^2 x_2) - x_2(-x_2 + x_2^2 + x_1 x_2 - x_1^3) \\ &= (x_1^2 + x_1 x_2)^2 + x_2^2(1 - x_2 - x_1 - x_1^2) \end{aligned}$$

For any  $0 < c < 1$ , there is a domain around the origin where

$$1 - x_2 - x_1 - x_1^2 > c > 0$$

Hence, in this domain, we have

$$\dot{V}(x) \geq (x_1^2 + x_1 x_2)^2 + c x_2^2$$

## 《非线性系统（第三版）》习题解答

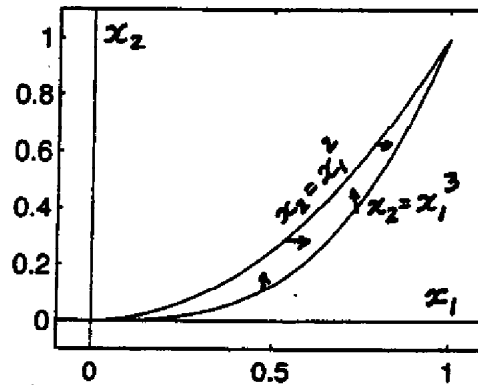

Figure 4.1: Exercise 4.13 (2).

The right-hand side of the preceding inequality is positive definite; hence all the conditions of Chetaev's theorem are satisfied and the equilibrium point at the origin is unstable.

(2) The system

$$\dot{x}_1 = -x_1^3 + x_2 = f_1(x), \quad \dot{x}_2 = x_1^6 - x_2^3 = f_2(x)$$

has two equilibrium points at  $(0,0)$  and  $(1,1)$ . The set  $\Gamma = \{0 \leq x_1 \leq 1\} \cap \{x_2 \geq x_1^3\} \cap \{x_2 \leq x_1^2\}$  is shown in Figure 4.1. On the boundary  $x_2 = x_1^2$ ,  $f_2 = 0$  and  $f_1 > 0$ ; hence, all trajectories on this boundary move into  $\Gamma$ . On the boundary  $x_2 = x_1^3$ ,  $f_1 = 0$  and  $f_2 > 0$ ; hence, all trajectories on this boundary move into  $\Gamma$ . Thus,  $\Gamma$  is positively invariant. Inside  $\Gamma$ , both  $f_1$  and  $f_2$  are positive. Thus all trajectories move toward the equilibrium point  $(1,1)$ . Since this happens for trajectories starting arbitrarily close to the origin, we conclude that the origin is unstable.

### • 4.14

$$\int_0^{x_1} yg(y) dy \geq \int_0^{x_1} y dy = \frac{1}{2}x_1^2$$

Therefore,

$$V(x) \geq \frac{1}{2}x_1^2 + x_1x_2 + x_2^2 = \frac{1}{2}x^T \begin{bmatrix} 1 & 1 \\ 1 & 2 \end{bmatrix} x$$

The matrix of the quadratic form is positive definite. Hence,  $V(x)$  is positive definite for all  $x$ , and radially unbounded.

$$\begin{aligned} \dot{V} &= x_1g(x_1)\dot{x}_1 + x_1\dot{x}_2 + x_2\dot{x}_1 + 2x_2\dot{x}_2 \\ &= g(x_1)(x_1x_2 - x_1^2 - x_1x_2 - 2x_1x_2 - 2x_2^2) + x_2^2 \\ &= -g(x_1)(x_1^2 + 2x_1x_2 + 2x_2^2) + x_2^2 \\ &= -g(x_1)x^T Qx + x_2^2 \end{aligned}$$

where  $Q = \begin{bmatrix} 1 & 1 \\ 1 & 2 \end{bmatrix}$  is positive definite. Since  $g(x_1) \geq 1$  and  $x^T Qx \geq 0$ , we have

$$\dot{V} \leq -(x_1^2 + 2x_1x_2 + 2x_2^2) + x_2^2 = -(x_1^2 + 2x_1x_2 + x_2^2) = -(x_1 + x_2)^2$$

This shows that  $\dot{V}$  is negative semidefinite. We need to apply the invariance principle.

$$\dot{V} = 0 \Rightarrow 0 \leq -(x_1 + x_2)^2 \Rightarrow 0 \geq (x_1 + x_2)^2 \Rightarrow x_1 + x_2 = 0$$

## 《非线性系统（第三版）》习题解答

$$x_1(t) + x_2(t) \equiv 0 \Rightarrow \dot{x}_1(t) + \dot{x}_2(t) \equiv 0 \Rightarrow x_2(t) \equiv 0 \Rightarrow x_1(t) \equiv 0$$

Since  $V(x)$  is radially unbounded and all the assumptions hold globally, we conclude that the origin is globally asymptotically stable.

- 4.15 (a) The equilibrium points are the roots of the equations

$$0 = x_2, \quad 0 = -h_1(x_1) - x_2 - h_2(x_3), \quad 0 = x_2 - x_3$$

$$x_2 = 0 \Rightarrow x_3 = 0 \Rightarrow h_1(x_1) = 0 \Rightarrow x_1 = 0$$

Hence, there is a unique equilibrium point at the origin.

(b)  $V(x)$  is the sum of nonnegative terms; hence  $V(x) \geq 0$ . To show that it is positive definite for all  $x$ , we need to show that  $V(x) = 0 \Rightarrow x = 0$ . Since  $y h_i(y) > 0$  for all  $y \neq 0$ , the integrals  $\int_0^{x_1} h_1(y) dy$  and  $\int_0^{x_3} h_2(y) dy$  vanish only at  $x_1 = 0$  and  $x_3 = 0$ , respectively. Hence,  $V(x)$  is positive definite.

(c)

$$\dot{V} = h_1(x)x_2 + x_2[-h_1(x_1) - x_2 - h_2(x_3)] + h_2(x_3)(x_2 - x_3) = -x_2^2 - x_3 h_2(x_3)$$

$\dot{V}(x)$  is negative semidefinite for all  $x$ , but not negative definite because  $\dot{V}(x) = 0$  when  $x_2 = x_3 = 0$  for any  $x_1$ . We apply the invariance principle.

$$x_2(t) \equiv 0 \text{ and } x_3(t) \equiv 0 \Rightarrow h_1(x_1(t)) \equiv 0 \Rightarrow x_1(t) \equiv 0$$

Hence, the origin is asymptotically stable.

(d) To show global asymptotic stability we need  $V(x)$  to be radially unbounded. This will be the case if the integrals  $\int_0^x h_i(y) dy$ ,  $i = 1, 2$ , tend to infinity as  $|x| \rightarrow \infty$ .

- 4.16 Let  $V(x) = (1/4)x_1^4 + (1/2)x_2^2$ .

$$\dot{V} = x_1^3 x_2 - x_1^3 x_2 - x_2^4 = -x_2^4$$

$\dot{V}(x)$  is negative semidefinite for all  $x$ .

$$x_2(x) \equiv 0 \Rightarrow x_1^3(t) \equiv 0 \Rightarrow x_1(t) \equiv 0$$

By the invariance principle, the origin is globally asymptotically stable.

- 4.17

(a)

$$\dot{x}_1 = x_2, \quad \dot{x}_2 = -g(x_1) - h(x_1)x_2$$

At equilibrium,

$$x_2 = 0 \text{ \& } g(x_1) + h(x_1)x_2 = 0 \Rightarrow x_2 = 0 \text{ \& } g(x_1) = 0$$

Assume that  $g(x_1) = 0$  has an isolated root at the origin. Then, the origin is an isolated equilibrium point.

(b) With  $V(x) = \int_0^{x_1} g(y) dy + \frac{1}{2}x_2^2$ , we have

$$\dot{V}(x) = g(x_1)x_2 - x_2g(x_1) - h(x_1)x_2^2 = -h(x_1)x_2^2 \leq 0$$

Assume that  $h(x_1) > 0 \forall x_1 \in D$  (a domain that contains the origin). Then,  $\dot{V} \leq 0$  and

$$\dot{V} \equiv 0 \Rightarrow h(x_1(t))x_2^2(t) \equiv 0 \Rightarrow x_2(t) \equiv 0 \Rightarrow g(x_1(t)) \equiv 0 \Rightarrow x_1(t) \equiv 0$$

## 《非线性系统（第三版）》习题解答

Hence, by LaSalle's theorem (Corollary 4.1), the origin is asymptotically stable.

(c) With  $V(x) = \frac{1}{2} [x_2 + \int_0^{x_1} h(y) dy]^2 + \int_0^{x_1} g(y) dy$ , we have

$$\begin{aligned}
 \dot{V} &= \left[ x_2 + \int_0^{x_1} h(y) dy \right] [\dot{x}_2 + h(x_1)\dot{x}_1] + \dot{x}_1 g(x_1) \\
 &= \left[ x_2 + \int_0^{x_1} h(y) dy \right] [-g(x_1) - h(x_1)x_2 + h(x_1)x_2] + x_2 g(x_1) \\
 &= -g(x_1) \int_0^{x_1} h(y) dy
 \end{aligned}$$

Assume that  $g(x_1) \int_0^{x_1} h(y) dy \geq 0$  and  $\int_0^{x_1} h(y) dy \neq 0$ . Then,  $\dot{V} \leq 0$  and

$$\dot{V} \equiv 0 \Rightarrow g(x_1(t)) \equiv 0 \Rightarrow x_1(t) \equiv 0 \Rightarrow x_2(t) \equiv 0$$

Hence, by LaSalle's theorem (Corollary 4.1), the origin is asymptotically stable.

• 4.18 The system has an equilibrium point at  $y = Mg/k$  and  $\dot{y} = 0$ . Let  $x_1 = y - Mg/k$  and  $x_2 = \dot{y}$ .

$$\dot{x}_1 = x_2, \quad \dot{x}_2 = -\frac{k}{M}x_1 - \frac{c_1}{M}x_2 - \frac{c_2}{M}x_2|x_2|$$

Take  $V(x) = ax_1^2 + bx_2^2$ , with  $a, b > 0$ .  $V(x)$  is positive definite and radially unbounded.

$$\dot{V}(x) = 2 \left( a - \frac{bk}{M} \right) x_1 x_2 - \frac{2bc_1}{M} x_2^2 - \frac{2bc_2}{M} x_2^2 |x_2|$$

Taking  $a = k/2$  and  $b = M/2$ , we obtain

$$\dot{V}(x) = -c_1 x_2^2 - c_2 x_2^2 |x_2| \leq 0, \quad \forall x$$

Moreover,

$$\dot{V} \equiv 0 \Rightarrow x_2(t) \equiv 0 \Rightarrow x_1(t) \equiv 0$$

Using LaSalle's theorem (Corollary 4.2), we conclude that the origin is globally asymptotically stable.

• 4.19 The equation of motion is

$$M(q)\ddot{q} + C(q, \dot{q})\dot{q} + D\dot{q} + g(q) = u$$

where  $M(q) = M^T(q)$  is positive definite,  $\dot{M} - 2C$  is skew symmetric,  $D = D^T$  is positive semidefinite,  $g(q) = 0$  has an isolated root at  $q = 0$ ,  $g(q) = [\partial P(q)/\partial q]^T$ , and  $P(q)$  is positive definite. The  $2m$ -dimensional state vector can be taken as  $x = \begin{bmatrix} q \\ \dot{q} \end{bmatrix}$ .

(a) Let  $u = 0$  and  $V = \frac{1}{2}\dot{q}^T M(q)\dot{q} + P(q)$ .  $V$  is a positive definite function of  $x$ .

$$\dot{V} = \dot{q}^T M\ddot{q} + \frac{1}{2}\dot{q}^T \dot{M}\dot{q} + g^T \dot{q} = \frac{1}{2}\dot{q}^T (\dot{M} - 2C)\dot{q} - \dot{q}^T D\dot{q} - \dot{q}^T g + g^T \dot{q} = -\dot{q}^T D\dot{q} \leq 0$$

Hence, the origin is stable.

(b) With  $u = -K_d \dot{q}$ , we have  $\dot{V} = -\dot{q}^T (K_d + D)\dot{q} \leq 0$ . Moreover,

$$\dot{V} \equiv 0 \Rightarrow \dot{q} \equiv 0 \Rightarrow \ddot{q} \equiv 0 \Rightarrow g(q) \equiv 0 \Rightarrow q \equiv 0$$

## 《非线性系统（第三版）》习题解答

Hence, by LaSalle's theorem (Corollary 4.1), the origin is asymptotically stable.

(c) With  $u = g(q) - K_p(q - q^*) - K_d\dot{q}$ , the equation of motion is given by

$$M(q)\ddot{q} + C(q, \dot{q})\dot{q} + D\dot{q} + K_p(q - q^*) + K_d\dot{q} = 0$$

There is an equilibrium point at  $q = q^*$  and  $\dot{q} = 0$ . Take

$$x = \begin{bmatrix} q - q^* \\ \dot{q} \end{bmatrix} \stackrel{\text{def}}{=} \begin{bmatrix} e \\ \dot{e} \end{bmatrix}$$

$V = \frac{1}{2}\dot{e}^T M \dot{e} + \frac{1}{2}e^T K_p e$  is positive definite.

$$\dot{V} = \dot{e}^T M \ddot{q} + \frac{1}{2}\dot{e}^T \dot{M} \dot{e} + e^T K_p \dot{e} = \frac{1}{2}\dot{e}^T (\dot{M} - 2C)\dot{e} - \dot{e}^T K_p e - \dot{e}^T (K_d + D)\dot{e} + e^T K_p \dot{e} = -\dot{e}^T (K_d + D)\dot{e} \leq 0$$

$$\dot{V} \equiv 0 \Rightarrow \dot{e} \equiv 0 \Rightarrow \ddot{e} \equiv 0 \Rightarrow K_p e \equiv 0 \Rightarrow e \equiv 0$$

Hence, by LaSalle's theorem (Corollary 4.1), the equilibrium point  $(q^*, 0)$  is asymptotically stable.

• 4.20 According to LaSalle's theorem,  $x(t)$  approaches  $M$  as  $t \rightarrow \infty$ . Equivalently, given  $\varepsilon > 0$  there is  $T > 0$  such that

$$\inf_{y \in M} \|x(t) - y\| < \varepsilon, \quad \forall t > T$$

Choose  $\varepsilon$  so small that the neighborhood  $N(p, 2\varepsilon)$  of  $p \in M$  contains no other points in  $M$ .

**Claim:**  $\|x(t) - p\| < \varepsilon$ , for all  $t > T$ , for some  $p \in M$ .

The claim can be proved by contradiction. At  $t = t_1 > T$ , let  $p_1 \in M$  be a point for which  $\|x(t_1) - p_1\| < \varepsilon$ . Suppose there is time  $t_2 > t_1$  such that  $\|x(t_2) - p_1\| = \varepsilon$ . Let  $p \neq p_1$  be any other point of  $M$ . Then

$$\begin{aligned} \|x(t_2) - p\| &= \|x(t_2) - p_1 + p_1 - p\| \\ &\geq \|p_1 - p\| - \|x(t_2) - p_1\| \geq 2\varepsilon - \varepsilon = \varepsilon \\ &\Rightarrow \inf_{y \in M} \|x(t) - y\| \geq \varepsilon \end{aligned}$$

The last statement contradicts the fact that  $\inf_{y \in M} \|x(t) - y\| < \varepsilon$  for all  $t > T$ , which proves the claim. Since this claim is true for any, sufficiently small,  $\varepsilon > 0$ , it is equivalent to  $x(t) \rightarrow p$  as  $t \rightarrow \infty$ , for some  $p \in M$ .

• 4.21

(a)

$$\dot{V}(x) = \frac{\partial V}{\partial x} \dot{x} = -(\nabla V)^T (\nabla V) \leq 0$$

$$\dot{V}(x) = 0 \Leftrightarrow \nabla V(x) = 0 \Leftrightarrow \dot{x} = 0$$

Hence,  $\dot{V}(x) = 0$  if and only if  $x$  is an equilibrium point.

(b) Every solution starts in a set  $\Omega_c$  with  $c \geq V(x_0)$ . Since  $\dot{V} \leq 0$  in  $\Omega_c$ , the solution remains in  $\Omega_c$  for all  $t \geq 0$ . Since  $\Omega_c$  is compact, we conclude by Theorem 3.3 that the solution is defined for all  $t \geq 0$ .

(c) By LaSalle's theorem,  $x(t) \rightarrow M = \{p_1, \dots, p_r\}$  as  $t \rightarrow \infty$ . Since the points  $p_1, \dots, p_r$  are isolated, we conclude from Exercise 4.20 that  $x(t) \rightarrow p_i$  as  $t \rightarrow \infty$  for some  $p_i \in M$ .

• 4.22

**Sufficiency:** Suppose there is  $P = P^T > 0$  such that

$$PA + A^T P = -C^T C$$

## 《非线性系统（第三版）》习题解答

Let  $V(x) = x^T P x$ .

$$\dot{V}(x) = -x^T C^T C x \leq 0$$

$$\dot{V}(x) = 0 \Rightarrow Cx(t) \equiv 0 \Rightarrow C \exp(At)x_0 \equiv 0 \Rightarrow x_0 = 0$$

since the pair  $(A, C)$  is observable. By LaSalle's Theorem (Corollary 4.2), the origin is globally asymptotically stable.

**Necessity:** Suppose  $A$  is Hurwitz. Let

$$P = \int_0^{\infty} \exp(A^T t) C^T C \exp(At) dt$$

$P$  is symmetric and positive semidefinite by construction. To show that it is positive definite, suppose it is not so. Then, there is  $x \neq 0$  such that  $x^T P x = 0$ . Consequently

$$\int_0^{\infty} x^T \exp(A^T t) C^T C \exp(At) x dt = 0 \Rightarrow C \exp(At)x \equiv 0 \Rightarrow x = 0$$

Hence,  $P$  is positive definite. Similar to the proof of Theorem 4.6, it can be shown that  $P$  satisfies the equation

$$PA + A^T P = -C^T C$$

and that it is the unique solution.

• 4.23

(1) Let  $V(x) = x^T P x$ .

$$\dot{V}(x) = x^T [P(A - BR^{-1}B^T P) + (A - BR^{-1}B^T P)^T P] x$$

Using the Riccati equation, we obtain

$$\dot{V}(x) = -x^T (Q + PBR^{-1}B^T P)x$$

$$Q > 0 \Rightarrow Q + PBR^{-1}B^T P > 0$$

Hence,  $\dot{V}(x)$  is negative definite and the origin is globally asymptotically stable.

(2) When  $Q = C^T C$ , we can only conclude that  $V(x)$  is negative semidefinite. But

$$\begin{aligned} \dot{V}(x) = 0 &\Rightarrow x^T(t)(Q + PBR^{-1}B^T P)x(t) \equiv 0 \\ &\Rightarrow Cx(t) \equiv 0 \text{ and } R^{-1}B^T P x(t) \equiv 0 \end{aligned}$$

Due to the second identity, the state equation simplifies to

$$\dot{x} = Ax - BR^{-1}B^T P x = Ax$$

and its solution is given by  $x(t) = C \exp(At)x_0$ . Thus

$$C \exp(At)x_0 \equiv 0 \Rightarrow x_0 \equiv 0$$

since  $(A, C)$  is observable. By LaSalle's theorem (Corollary 4.2), we conclude that the origin is globally asymptotically stable.

• 4.24

$$\dot{V}(x) = \frac{\partial V}{\partial x} f(x) - k \frac{\partial V}{\partial x} G(x) R^{-1}(x) G^T(x) \left( \frac{\partial V}{\partial x} \right)^T$$

## 《非线性系统（第三版）》习题解答

Substitute for  $[\partial V/\partial x]f$  using the Hamilton–Jacobi–Bellman equation.

$$\dot{V}(x) = -q(x) - (k - \frac{1}{4}) \frac{\partial V}{\partial x} G(x) R^{-1}(x) G^T(x) \left( \frac{\partial V}{\partial x} \right)^T$$

If  $q(x)$  is positive definite and  $k \geq 1/4$ , we conclude that  $\dot{V}(x)$  is negative definite; hence, the origin is asymptotically stable. If  $q(x)$  is only negative semidefinite and  $k > 1/4$ , we can only conclude that  $\dot{V}(x)$  is negative semidefinite. But

$$\dot{V}(x) = 0 \Rightarrow q(x) \text{ and } G^T(x) \left( \frac{\partial V}{\partial x} \right)^T = 0 \Rightarrow \dot{x} = f(x)$$

Since the only solution of  $\dot{x} = f(x)$  can stay identically in the set  $\{q(x) = 0\}$  is the zero solution, we see that

$$q(x(t)) \equiv 0 \Rightarrow x(t) \equiv 0$$

By LaSalle's theorem (Corollary 4.1), we conclude that the origin is asymptotically stable. The origin will be globally asymptotically stable if all the assumptions hold globally and  $V(x)$  is radially unbounded.

• 4.25 Since  $(A, B)$  is controllable, the controllability Gramian  $W = \int_0^T e^{-At} B B^T [e^{-At}]^T dt$  is positive definite. Hence,  $W^{-1}$  is positive definite. Note that

$$\begin{aligned} AW + WA^T &= \int_0^T \left\{ A e^{-At} B B^T [e^{-At}]^T + e^{-At} B B^T [e^{-At}]^T A^T \right\} dt \\ &= - \int_0^T \frac{d}{dt} \left\{ e^{-At} B B^T [e^{-At}]^T \right\} dt = B B^T - e^{-A^T} B B^T [e^{-A^T}]^T \end{aligned}$$

Hence,

$$(A - BK)W + W(A - BK)^T = AW + WA^T - 2BB^T = -e^{-A^T} B B^T [e^{-A^T}]^T - BB^T$$

With  $V(x) = x^T W^{-1} x$ , we have

$$\dot{V}(x) = x^T W^{-1} [(A - BK)W + W(A - BK)^T] W^{-1} x = -x^T W^{-1} \left\{ e^{-A^T} B B^T [e^{-A^T}]^T + B B^T \right\} W^{-1} x \leq 0$$

Hence, the origin of  $\dot{x} = (A - BK)x$  is stable; all eigenvalues of  $(A - BK)$  satisfy  $\text{Re}[\lambda] \leq 0$ . Now we want to show that  $\text{Re}[\lambda] < 0$ . Let  $\lambda$  have  $\text{Re}[\lambda] = 0$  and let  $\nu$  be the left eigenvector of  $(A - BK)$  corresponding to  $\lambda$ . Then

$$\nu^*(A - BK) = \lambda \nu^* \text{ and } (A - BK)^T \nu = \lambda^* \nu$$

We have

$$\begin{aligned} (A - BK)W + W(A - BK)^T &= -e^{-A^T} B B^T [e^{-A^T}]^T - B B^T \\ \nu^*(A - BK)W\nu + \nu^*W(A - BK)^T\nu &= -\nu^*e^{-A^T} B B^T [e^{-A^T}]^T\nu - \nu^*B B^T\nu \\ \Rightarrow \lambda \nu^*W\nu + \lambda^* \nu^*W\nu &= -\nu^*e^{-A^T} B B^T [e^{-A^T}]^T\nu - \nu^*B B^T\nu \\ \Rightarrow 2(\text{Re}[\lambda])\nu^*W\nu &= -\nu^*e^{-A^T} B B^T [e^{-A^T}]^T\nu - \nu^*B B^T\nu \end{aligned}$$

Thus

$$\text{Re}[\lambda] = 0 \Rightarrow \nu^*B B^T\nu = 0 \Rightarrow \nu^*B = 0$$

which contradicts the controllability of  $(A, B)$ . Thus, all the eigenvalues of  $(A - BK)$  have negative real parts.

## 《非线性系统（第三版）》习题解答

• 4.26

(a) Suppose  $x = 0$  is an isolated equilibrium point. Clearly  $z = 0$  is an equilibrium point. We can show that it is isolated by contradiction. Suppose it is not isolated. Then there is  $\bar{z} \neq 0$ , arbitrarily close to 0, such that  $\hat{f}(\bar{z}) = 0$ . Define  $\bar{x} = T^{-1}(\bar{z})$ . Then,  $f(\bar{x}) = [\partial T / \partial x]^{-1} \hat{f}(\bar{z}) = 0$ ; that is,  $\bar{x}$  is an equilibrium point. By continuity of  $T^{-1}(\cdot)$ , we can make  $\bar{x}$  arbitrarily close the origin, which contradict the fact that the origin is an isolated equilibrium point. Clearly the argument works the other way around. Hence,  $x = 0$  is an isolated equilibrium point if and only if  $z = 0$  is an isolated equilibrium point.

(b) Suppose  $x = 0$  is a stable equilibrium point. Then, given  $\varepsilon_1 > 0$  there is  $\delta_1 > 0$  such that

$$\|x(0)\| < \delta_1 \Rightarrow \|x(t)\| < \varepsilon_1, \quad \forall t \geq 0$$

By continuity of  $T(\cdot)$ : Given  $\varepsilon_2 > 0$  there is  $r > 0$  such that

$$\|x\| < r \Rightarrow \|z\| < \varepsilon_2$$

Thus, there exists  $\delta > 0$  such that

$$\|x(0)\| < \delta \Rightarrow \|x(t)\| < r \Rightarrow \|z(t)\| < \varepsilon_2, \quad \forall t \geq 0$$

By continuity of  $T^{-1}(\cdot)$ , there is  $\delta_2 > 0$  such that

$$\|z\| < \delta_2 \Rightarrow \|x\| < \delta$$

Hence

$$\|z(0)\| < \delta_2 \Rightarrow \|x(0)\| < \delta \Rightarrow \|x(t)\| < r \Rightarrow \|z(t)\| < \varepsilon_2, \quad \forall t \geq 0$$

Thus,  $z = 0$  is a stable equilibrium point.

Suppose now that  $x = 0$  is an asymptotically stable equilibrium point. Then

$$x(t) \rightarrow 0 \text{ as } t \rightarrow \infty$$

Given  $\varepsilon_1 > 0$  there is  $T_1 > 0$  such that  $\|x(t)\| < \varepsilon_1$  for all  $t > T_1$ . By continuity of  $T(\cdot)$ : Given  $\varepsilon_2 > 0$  there is  $r > 0$  such that

$$\|x\| < r \Rightarrow \|z\| < \varepsilon_2$$

There exists  $T_2 > 0$  such that

$$\|x(t)\| < r, \quad \forall t > T_2 \Rightarrow \|z(t)\| < \varepsilon_2, \quad \forall t > T_2$$

Hence

$$z(t) \rightarrow 0 \text{ as } t \rightarrow \infty$$

and  $z = 0$  is asymptotically stable. The opposite direction of the proof is done similarly. Now

$$x = 0 \text{ is stable} \Leftrightarrow z = 0 \text{ is stable}$$

is equivalent to

$$x = 0 \text{ is unstable} \Leftrightarrow z = 0 \text{ is unstable}$$

• 4.27 (a) The equilibrium points are the roots of the equations

$$0 = -x_2 x_3 + 1, \quad 0 = x_1 x_3 - x_2, \quad 0 = x_3^2(1 - x_3)$$

From the third equation,  $x_3 = 0$  or  $x_3 = 1$ . The first equation cannot be satisfied with  $x_3 = 0$ .

$$x_3 = 1 \Rightarrow x_2 = 1 \Rightarrow x_1 = x_2 = 1$$



## 《非线性系统（第三版）》习题解答

Hence, there is a unique equilibrium point at  $(1, 1, 1)$ .

(b)

$$\frac{\partial f}{\partial x} \Big|_{x=(1,1,1)} = \begin{bmatrix} 0 & -x_3 & -x_2 \\ x_3 & -1 & x_1 \\ 0 & 0 & 2x_3 - 3x_3^2 \end{bmatrix} \Big|_{x=(1,1,1)} = \begin{bmatrix} 0 & -1 & -1 \\ 1 & -1 & 1 \\ 0 & 0 & -1 \end{bmatrix}$$

The eigenvalues are  $-1$  and  $(-1 \pm j\sqrt{3})/2$ . Hence, the origin is asymptotically stable. The third state equation has equilibrium at  $x_3 = 0$ . Starting with the initial condition  $x_3(0) = 0$ , we have  $x_3(t) \equiv 0$ . Then,  $\dot{x}_1 = 1$  and  $x_1(t)$  grows unbounded. Thus, the equilibrium point is not globally asymptotically stable.

• 4.28

(a)

$$0 = x_1, \quad 0 = (x_1 x_2 - 1)x_2^3 + (x_1 x_2 - 1 + x_1^2)x_2$$

Substitution of  $x_1 = 0$  in the second equation yields

$$-x_2(1 + x_2^2) = 0 \Rightarrow x_2 = 0$$

Hence, the origin is the unique equilibrium point.

(b)

$$\frac{\partial f}{\partial x} \Big|_{x=0} = \begin{bmatrix} -1 & 0 \\ (x_2^3 + x_2^2 + 2x_1 x_2) & (4x_2^3 x_1 - 3x_2^2 + 2x_1 x_2 - 1 + x_1^2) \end{bmatrix} \Big|_{x=0} = \begin{bmatrix} -1 & 0 \\ 0 & -1 \end{bmatrix}$$

Hence, the origin is asymptotically stable.

(c) Let  $V(x) = x_1 x_2$ .

$$\dot{V}(x) = x_1 \dot{x}_2 + \dot{x}_1 x_2 = (x_1 x_2 - 1)x_1 x_2^3 + (x_1 x_2 - 1 + x_1^2)x_1 x_2 - x_1 x_2$$

$$\dot{V}(x) \Big|_{x_1 x_2 = 2} = 4x_2^2 > 0$$

which implies that  $\Gamma$  is a positively invariant set.

(d) The origin is not globally asymptotically stable since trajectories starting in  $\Gamma$  do not converge to the origin.

• 4.29 (a) The equilibrium points are the roots of the equations

$$0 = x_1 - x_1^3 + x_2, \quad 0 = 3x_1 - x_2$$

$$x_2 = 3x_1 \Rightarrow x_1(4 - x_1^2) = 0$$

The equilibrium points are  $(0, 0)$ ,  $(2, 6)$ , and  $(-2, -6)$ .

(b)

$$\frac{\partial f}{\partial x} = \begin{bmatrix} 1 - 3x_1^2 & 1 \\ 3 & -1 \end{bmatrix}$$

$$\frac{\partial f}{\partial x} \Big|_{x=(0,0)} = \begin{bmatrix} 1 & 1 \\ 3 & -1 \end{bmatrix} \Rightarrow \lambda^2 - 4 = 0 \Rightarrow \lambda = \pm 2$$

The equilibrium point  $(0, 0)$  is unstable (saddle).

$$\frac{\partial f}{\partial x} \Big|_{x=(2,6)} = \begin{bmatrix} -11 & 1 \\ 3 & -1 \end{bmatrix} \Rightarrow \lambda^2 + 12\lambda + 8 = 0 \Rightarrow \lambda = -11.29, -0.71$$

The equilibrium point  $(2, 6)$  is asymptotically stable (stable node).

$$\frac{\partial f}{\partial x} \Big|_{x=(-2,-6)} = \begin{bmatrix} -11 & 1 \\ 3 & -1 \end{bmatrix}$$

## 《非线性系统（第三版）》习题解答

The equilibrium point  $(-2, -6)$  is asymptotically stable (stable node).

(c) Let  $A = \begin{bmatrix} -11 & 1 \\ 3 & -1 \end{bmatrix}$  and  $P$  be the solution of  $PA + A^T P = -I$ . Using Matlab,  $P$  is found to be  $P = \begin{bmatrix} 0.0938 & 0.1771 \\ 0.1771 & 0.6771 \end{bmatrix}$ . The eigenvalues of  $P$  are  $\lambda_{max}(P) = 0.7266$  and  $\lambda_{min}(P) = 0.0442$ . To estimate the region of attraction of  $(2, 6)$ , shift the equilibrium point to the origin via the change of variables

$$\tilde{x}_1 = x_1 - 2, \quad \tilde{x}_2 = x_2 - 6$$

The state equation in the new coordinates is given by

$$\begin{aligned} \dot{\tilde{x}}_1 &= -11\tilde{x}_1 + \tilde{x}_2 - 6\tilde{x}_1^2 - \tilde{x}_1^3 \\ \dot{\tilde{x}}_2 &= 3\tilde{x}_1 - \tilde{x}_2 \end{aligned}$$

We use  $V = \tilde{x}^T P \tilde{x}$  as a Lyapunov function candidate. The derivative  $\dot{V}$  is given by

$$\begin{aligned} \dot{V} &= -\tilde{x}^T \tilde{x} - 2(p_{11}\tilde{x}_1 + p_{12}\tilde{x}_2)(6 + \tilde{x}_1)\tilde{x}_1^2 \\ &\leq -\|\tilde{x}\|_2^2 - 12(p_{11}\tilde{x}_1 + p_{12}\tilde{x}_2)\tilde{x}_1^2 - 2p_{12}\tilde{x}_1^3\tilde{x}_2 \\ &\leq -\|\tilde{x}\|_2^2 + 12\sqrt{p_{11}^2 + p_{12}^2}\|\tilde{x}\|_2^3 + p_{12}\|\tilde{x}\|_2^4 \\ &\leq -(1 - 2.4r - 0.1771r^2)\|\tilde{x}\|_2^2, \quad \text{for } \|\tilde{x}\|_2 \leq r \end{aligned}$$

Taking  $r = 0.4$ , we see that  $\dot{V}(\tilde{x})$  is negative in  $\{\|\tilde{x}\|_2 \leq r\}$ . Choosing  $c < \lambda_{min}(P)r^2 = 0.00707$ , ensures that  $\{V(\tilde{x}) \leq c\} \subset \{\|\tilde{x}\|_2 \leq r\}$  because  $\lambda_{min}(P)\|\tilde{x}\|_2^2 \leq V(\tilde{x})$ . Take  $c = 0.007$ . Thus, the region of attraction is estimated by  $\{\tilde{x}^T P \tilde{x} \leq 0.007\}$ . The estimate of the region of attraction of  $(-2, -6)$  is done similarly and the constant  $c$  is chosen to be 0.007. A less conservative estimate of the region of attraction can be obtained graphically by plotting the contour of  $V(\tilde{x}) = 0$  in the  $x_1$ - $x_2$  plane and then choosing  $c$  and plotting the surface  $V(\tilde{x}) = c$ , with increasing  $c$ , until we obtain the largest  $c$  for which the surface  $V(\tilde{x}) = c$  is inside the region  $\{\dot{V}(\tilde{x}) < 0\}$ . The constant  $c$  is determined to be 0.1. The two estimates of the region of attraction are shown in Figure 4.2.

(d) The phase portrait is shown in Figure 4.3 together with the estimates of the region of attraction obtained in part (c). The stable trajectories of the saddle form a separatrix that divides the plane into two halves, with the right half as the region of attraction of  $(2, 6)$  and the left half the region of attraction of  $(-2, -6)$ . Notice that the estimates of the regions of attraction are much smaller than the regions themselves.

• 4.30 (a) The equilibrium points are the roots of the equations

$$x_2 = \frac{1}{2} \tan(\pi x_1/2), \quad x_1 = \frac{1}{2} \tan(\pi x_2/2)$$

There are three equilibrium points at  $(-\frac{1}{2}, -\frac{1}{2})$ ,  $(0, 0)$ , and  $(\frac{1}{2}, \frac{1}{2})$ .

(b)

$$\begin{aligned} \frac{\partial f}{\partial x} &= \begin{bmatrix} -(\pi/4) \sec^2(\pi x_1/2) & 1 \\ 1 & -(\pi/4) \sec^2(\pi x_2/2) \end{bmatrix} \\ \frac{\partial f}{\partial x} \Big|_{(-\frac{1}{2}, -\frac{1}{2})} &= \begin{bmatrix} -(\pi/2) & 1 \\ 1 & -(\pi/2) \end{bmatrix}, \quad \text{Eigenvalues are } -(\pi/2) \pm 1 \\ \frac{\partial f}{\partial x} \Big|_{(0,0)} &= \begin{bmatrix} -(\pi/4) & 1 \\ 1 & -(\pi/4) \end{bmatrix}, \quad \text{Eigenvalues are } -(\pi/4) \pm 1 \\ \frac{\partial f}{\partial x} \Big|_{(\frac{1}{2}, \frac{1}{2})} &= \begin{bmatrix} -(\pi/2) & 1 \\ 1 & -(\pi/2) \end{bmatrix}, \quad \text{Eigenvalues are } -(\pi/2) \pm 1 \end{aligned}$$

## 《非线性系统（第三版）》习题解答

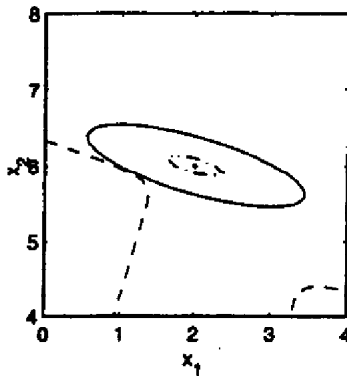

Figure 4.2: Exercise 4.29. The dotted line is the contour of  $\dot{V}(\bar{x}) = 0$ , the dash-dot line is the contour of  $V(\bar{x}) = 0.007$ , and the solid line is the contour of  $V(\bar{x}) = 0.1$ .

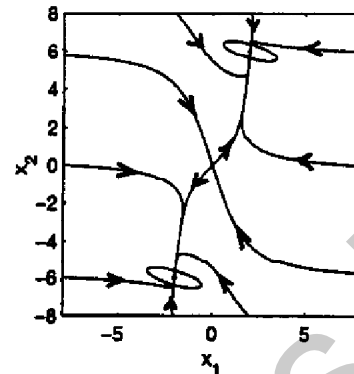

Figure 4.3: Exercise 4.29. Phase portrait with estimates of the regions of attraction.

Thus, the equilibrium points  $(-\frac{1}{2}, -\frac{1}{2})$ , and  $(\frac{1}{2}, \frac{1}{2})$  are asymptotically stable (stable nodes) while the equilibrium point  $(0, 0)$  is unstable (saddle).

(c) Let us start with the equilibrium point  $(\frac{1}{2}, \frac{1}{2})$ . Define  $y_1 = x_1 - \frac{1}{2}$  and  $y_2 = x_2 - \frac{1}{2}$ . In the  $y$ -coordinates the system is represented by

$$\dot{y} = Ay + g(y), \quad \text{where } A = \begin{bmatrix} -(\pi/2) & 1 \\ 1 & -(\pi/2) \end{bmatrix}$$

$$g(y) = \begin{bmatrix} -(1/2) \tan(\pi y_1/2 + \pi/4) + \pi y_1/2 + 1/2 \\ -(1/2) \tan(\pi y_2/2 + \pi/4) + \pi y_2/2 + 1/2 \end{bmatrix}$$

The solution of the Lyapunov equation  $PA + A^T P = -I$  is

$$P = \frac{\pi}{(\pi^2 - 4)} \begin{bmatrix} 1 & 2/\pi \\ 2/\pi & 1 \end{bmatrix}$$

Using  $V(y) = y^T P y$  as a Lyapunov function candidate, we obtain

$$\dot{V}(y) = -y^T y + 2y^T P g(y)$$

$\dot{V}(y)$  is negative in some neighborhood of  $y = 0$ . Using the “contour” command of matlab, we have plotted the contour of  $\dot{V}(y) = 0$  and the contours of  $V(y) = c$  for different values of  $c$ . We found that the choice  $c = 0.07$  results in a set  $\{V(y) \leq 0.07\}$  which is a subset of the region where  $\dot{V}(y)$  is negative as well as the rectangle  $\{-1 < x_1 < 1\}$ ; see Figure 4.4. Similarly, the region of attraction of  $(-\frac{1}{2}, -\frac{1}{2})$  is estimated by the same Lyapunov surface  $V(y) = 0.07$ , except for the fact that now  $y_1 = x_1 + \frac{1}{2}$  and  $y_2 = x_2 + \frac{1}{2}$ .

(d) The phase portrait and the estimates of the regions of attraction are shown in Figure 4.5. The exact regions of attraction are the two halves of the plane separated by the separatrix formed of the stable trajectories of the saddle equilibrium point.

### • 4.31

$$(1) \quad \left. \frac{\partial f}{\partial x} \right|_{x=0} = \begin{bmatrix} -1+x_2 & x_1 \\ 0 & -1 \end{bmatrix}_{x=0} = \begin{bmatrix} -1 & 0 \\ 0 & -1 \end{bmatrix}, \quad \lambda_{1,2} = -1, -1$$

$$(2) \quad \left. \frac{\partial f}{\partial x} \right|_{x=0} = \begin{bmatrix} -1+3x_1^2+x_2^2 & -1+2x_1x_2 \\ 1+2x_1x_2 & -1+x_1^2+3x_2^2 \end{bmatrix}_{x=0} = \begin{bmatrix} -1 & -1 \\ 1 & -1 \end{bmatrix}, \quad \lambda_{1,2} = -1 \pm j$$

《非线性系统（第三版）》习题解答

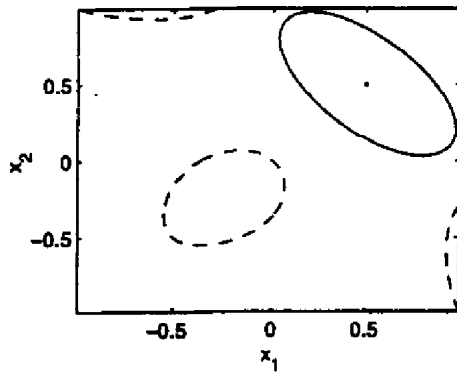

Figure 4.4: Exercise 4.30. The dotted line is the contour of  $\dot{V}(y) = 0$  and the solid line is the contour of  $V(y) = 0.07$ .

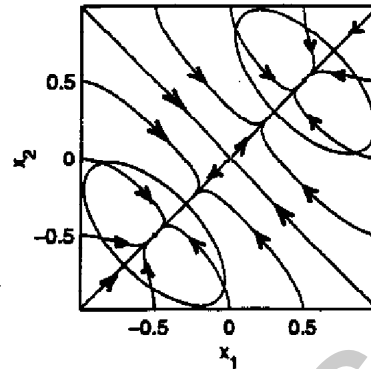

Figure 4.5: Exercise 4.30. Phase portrait with estimates of the regions of attraction.

$$(3) \quad \left. \frac{\partial f}{\partial x} \right|_{x=0} = \begin{bmatrix} -2x_1x_2 & 1-x_1^2 \\ -1+3x_1^2+2x_1x_2 & -(1-x_1^2) \end{bmatrix}_{x=0} = \begin{bmatrix} 0 & 1 \\ -1 & -1 \end{bmatrix}, \quad \lambda_{1,2} = (-1 \pm j\sqrt{3})/2$$

$$(4) \quad \left. \frac{\partial f}{\partial x} \right|_{x=0} = \begin{bmatrix} -1 & -1 \\ 2 & -3x_2^2 \end{bmatrix}_{x=0} = \begin{bmatrix} -1 & -1 \\ 2 & 0 \end{bmatrix}, \quad \lambda_{1,2} = (-1 \pm j\sqrt{7})/2$$

• 4.32 We investigate stability of the origin using linearization.

(1)

$$\frac{\partial f}{\partial x} = \begin{bmatrix} -1+2x_1 & 0 & 0 \\ 0 & -1 & 2x_3 \\ -2x_1 & 0 & 1 \end{bmatrix}, \quad A = \left. \frac{\partial f}{\partial x} \right|_{x=0} = \begin{bmatrix} -1 & 0 & 0 \\ 0 & -1 & 0 \\ 0 & 0 & 1 \end{bmatrix}$$

$A$  has an eigenvalue at 1; hence, the origin is unstable.

(2) Near the origin,  $\text{sat}(y) = y$  which implies that

$$z \stackrel{\text{def}}{=} -2x_3 - \text{sat}(y) = 2x_1 + 5x_2 - 4x_3$$

$$\frac{\partial f}{\partial x} = \begin{bmatrix} 0 & 1 & 0 \\ z^2 + 4x_1z & 10x_1z & -8x_1z - \cos x_3 \\ 2 & 5 & -4 \end{bmatrix}, \quad A = \left. \frac{\partial f}{\partial x} \right|_{x=0} = \begin{bmatrix} 0 & 1 & 0 \\ 0 & 0 & -1 \\ 2 & 5 & -4 \end{bmatrix}$$

The eigenvalues of  $A$  are  $-1, -1, -2$ ; hence, the origin is asymptotically stable.

(3)

$$\frac{\partial f}{\partial x} = \begin{bmatrix} -2+3x_1^2 & 0 & 0 \\ 2x_1 & -1 & 0 \\ 0 & 0 & -1 \end{bmatrix}, \quad A = \left. \frac{\partial f}{\partial x} \right|_{x=0} = \begin{bmatrix} -2 & 0 & 0 \\ 0 & -1 & 0 \\ 0 & 0 & -1 \end{bmatrix}$$

The eigenvalues of  $A$  are  $-2, -1, -1$ ; hence, the origin is asymptotically stable.

(4)

$$\frac{\partial f}{\partial x} = \begin{bmatrix} -1 & 0 & 0 \\ -1-x_3 & -1 & -1-x_1 \\ x_2 & 1+x_1 & 0 \end{bmatrix}, \quad A = \left. \frac{\partial f}{\partial x} \right|_{x=0} = \begin{bmatrix} -1 & 0 & 0 \\ -1 & -1 & -1 \\ 0 & 1 & 0 \end{bmatrix}$$

The eigenvalues of  $A$  are  $-1, -\frac{1}{2} \pm j\frac{\sqrt{3}}{2}$ ; hence, the origin is asymptotically stable.

## 《非线性系统（第三版）》习题解答

- **4.33** Since  $f(x)$  is twice continuously differentiable, we can represent it in some neighborhood of the origin by  $f(x) = -Bx + g(x)$ , where  $\|g(x)\|_2 \leq k\|x\|_2^2$ . The fact that the surface  $\{V(x) = c\}$  will be closed for sufficiently small  $c$  follows from continuity of  $V(x)$ .

$$\frac{\partial V}{\partial x} f(x) = \frac{\partial V}{\partial x} [-Bx + g(x)] = -x^T (PB + B^T P)x + 2x^T P g(x) = x^T x + 2x^T P g(x)$$

Using

$$\|2x^T P g(x)\|_2 \leq 2k\|P\|_2 \|x\|_2^3$$

we obtain

$$\frac{\partial V}{\partial x} f(x) \geq \|x\|_2^2 - 2k\|P\|_2 \|x\|_2^3 \geq \frac{1}{2}\|x\|_2^2 \quad \text{for } \|x\|_2 \leq \frac{1}{4k\|P\|_2}$$

Choosing  $c$  small enough so that the closed surface  $\{V(x) = c\}$  is contained in the ball  $\{\|x\|_2 \leq 1/(4k\|P\|_2)\}$ , we see that  $[\partial V/\partial x]f(x) > 0$  for all  $x \in \{V(x) = c\}$ .

- **4.34** Proof of Lemma 4.2.

- Since  $\alpha_1(\cdot)$  is continuous and strictly increasing on  $[0, a)$ , for each given  $y \in [0, \alpha_1(a))$  there is a unique  $x$  such that  $\alpha_1(x) = y$ . Define  $x = \alpha^{-1}(y)$ . The function  $\alpha^{-1}(\cdot)$  is continuous, vanishes at the origin, and is strictly increasing. Hence,  $\alpha^{-1}(\cdot)$  is a class  $\mathcal{K}$  function.
- From the previous item,  $\alpha_3^{-1}(\cdot)$  is a class  $\mathcal{K}$  function. Moreover, since  $\alpha_3(\cdot)$  is a class  $\mathcal{K}_\infty$  function,  $\alpha_3^{-1}(\cdot)$  is defined on  $[0, \infty)$  and  $\alpha_3^{-1}(r) \rightarrow \infty$  as  $r \rightarrow \infty$ . Hence  $\alpha_3^{-1}(\cdot)$  is a class  $\mathcal{K}_\infty$  function.
- Let  $\alpha(r) = \alpha_1(\alpha_2(r))$ . Then

$$\alpha(0) = 0; \quad \alpha(r) > 0, \quad \text{for } r > 0$$

$$r_2 > r_1 \Rightarrow \alpha_2(r_2) > \alpha_2(r_1) \Rightarrow \alpha_1(\alpha_2(r_2)) > \alpha_1(\alpha_2(r_1))$$

Therefore  $\alpha(\cdot)$  is strictly increasing. It is also continuous. Hence, it is a class  $\mathcal{K}$  function.

- From the previous item,  $\alpha(r) = \alpha_3(\alpha_4(r))$  is a class  $\mathcal{K}$  function. Moreover, it is defined for all  $r \geq 0$  and

$$r \rightarrow \infty \Rightarrow \alpha_4(r) \rightarrow \infty \Rightarrow \alpha(r) \rightarrow \infty$$

Hence,  $\alpha_3(\alpha_4(\cdot))$  is a class  $\mathcal{K}_\infty$  function.

- For each fixed  $s$ ,  $\beta(\alpha_2(r), s)$  is a class  $\mathcal{K}$  function of  $r$ . Thus  $\alpha_1(\beta(\alpha_2(r), s))$  is a class  $\mathcal{K}$  function of  $r$ . Now, for each fixed  $r$ ,  $\beta(\alpha_2(r), s)$  decreases as  $s$  increases. Hence,  $\alpha_1(\beta(\alpha_2(r), s))$  decreases as  $s$  increases. Moreover,  $\alpha_1(\beta(\alpha_2(r), s)) \rightarrow 0$  as  $s \rightarrow \infty$ . Hence,  $\alpha_1(\beta(\alpha_2(r), s))$  is a class  $\mathcal{KL}$  function.

- **4.35** If  $r_1 \geq r_2$ , we have  $r_1 + r_2 \leq 2r_1$ . Hence,

$$\alpha(r_1 + r_2) \leq \alpha(2r_1) \leq \alpha(2r_1) + \alpha(2r_2)$$

If  $r_2 \geq r_1$ , we have  $r_1 + r_2 \leq 2r_2$ . Hence,

$$\alpha(r_1 + r_2) \leq \alpha(2r_2) \leq \alpha(2r_1) + \alpha(2r_2)$$

Thus, the inequality

$$\alpha(r_1 + r_2) \leq \alpha(2r_1) + \alpha(2r_2)$$

is always satisfied.

- **4.36** This exercise is already dealt with in Example 4.18.

## 《非线性系统（第三版）》习题解答

• 4.37 (1) Let  $V(x) = \frac{1}{2}(x_1^2 + x_2^2)$ .

$$\begin{aligned}\dot{V} &= -x_1^2 + \alpha(t)x_1x_2 + \alpha(t)x_1x_2 - 2x_2^2 \leq -x_1^2 - 2x_2^2 + 2|x_1||x_2| \\ &= -\begin{bmatrix} |x_1| \\ |x_2| \end{bmatrix}^T \begin{bmatrix} 1 & -1 \\ -1 & 2 \end{bmatrix} \begin{bmatrix} |x_1| \\ |x_2| \end{bmatrix} \leq -0.382(x_1^2 + x_2^2)\end{aligned}$$

where 0.382 is the minimum eigenvalue of the  $2 \times 2$  matrix. By Theorem 4.10, the origin is exponentially stable.

(2) Let  $V(x) = \frac{1}{2}(x_1^2 + x_2^2)$ .

$$\dot{V} = -x_1^2 + \alpha(t)x_1x_2 - \alpha(t)x_1x_2 - 2x_2^2 = -x_1^2 - 2x_2^2$$

By Theorem 4.10, the origin is exponentially stable.

(3) Take  $V(x) = p_{11}x_1^2 + 2p_{12}x_1x_2 + p_{22}x_2^2$ , where  $p_{11}p_{22} - p_{12}^2 > 0$ , and let  $k$  be an upper bound on  $|\alpha(t)|$ .

$$\dot{V} = -2p_{12}x_1^2 + 2[p_{11} - p_{22} - \alpha(t)p_{12}]x_1x_2 + 2[p_{12} - \alpha(t)p_{22}]x_2^2$$

Take  $p_{11} = p_{22} = p > 1$  and  $p_{12} = 1$ .

$$\dot{V} \leq -2x_1^2 + 2k|x_1||x_2| - 2(2p-1)x_2^2 = -\begin{bmatrix} |x_1| \\ |x_2| \end{bmatrix}^T \begin{bmatrix} 2 & -k \\ -k & 2(2p-1) \end{bmatrix} \begin{bmatrix} |x_1| \\ |x_2| \end{bmatrix}$$

Choose  $p > (1 + k^2/4)/2$  so that  $4(2p-1) - k^2 > 0$ . Then, the  $2 \times 2$  matrix is positive definite and, by Theorem 4.10, the origin is exponentially stable.

(4) Take  $V(x) = p_{11}x_1^2 + 2p_{12}x_1x_2 + p_{22}x_2^2$ , where  $p_{11}p_{22} - p_{12}^2 > 0$ , and let  $k$  be an upper bound on  $|\alpha(t)|$ .

$$\dot{V} = -2[p_{11} - \alpha(t)p_{12}]x_1^2 + 2[-p_{12} + \alpha(t)p_{22} - 2p_{12}]x_1x_2 - 4p_{22}x_2^2$$

Take  $p_{12} = 0$  and  $p_{22} = 1$ .

$$\dot{V} \leq -2p_{11}x_1^2 + 2k|x_1||x_2| - 4x_2^2 = -\begin{bmatrix} |x_1| \\ |x_2| \end{bmatrix}^T \begin{bmatrix} 2p_{11} & -k \\ -k & 4 \end{bmatrix} \begin{bmatrix} |x_1| \\ |x_2| \end{bmatrix}$$

Choose  $p_{11} > k^2/8$  so that  $8p_{11} - k^2 > 0$ . Then, the  $2 \times 2$  matrix is positive definite and, by Theorem 4.10, the origin is exponentially stable.

• 4.38

(a) Using the bounds on  $L(t)$ ,  $C(t)$  and  $R(t)$ , we can show that

$$\begin{aligned}k_5 + \frac{2k_1}{k_6k_4} &\leq R(t) + \frac{2L(t)}{R(t)C(t)} \leq k_6 + \frac{2k_2}{k_5k_3} \\ \frac{2}{k_6} &\leq \frac{2}{R(t)} \leq \frac{2}{k_5}\end{aligned}$$

Using the upper bounds, it is clear that  $V(t, x)$  is decrescent. If we try to use the lower bounds to show that  $V(t, x)$  is positive definite, we will have to restrict the constants to satisfy

$$\frac{2k_5}{k_6} + \frac{4k_1}{k_6^2k_4} - 1 > 0$$

Instead of making this restriction, we work directly with  $V(t, x)$ , which can be written as

$$V(t, x) = x^T P x = x^T \begin{bmatrix} R(t) + \frac{2L(t)}{R(t)C(t)} & 1 \\ 1 & \frac{2}{R(t)} \end{bmatrix} x \geq x^T \begin{bmatrix} R(t) & 1 \\ 1 & \frac{2}{R(t)} \end{bmatrix} x \stackrel{\text{def}}{=} x^T \tilde{P} x$$

## 《非线性系统（第三版）》习题解答

It can be shown that the minimum eigenvalue of  $\tilde{P}$  is given by

$$\lambda_{\min}(\tilde{P}) = \frac{1}{2}(a - \sqrt{a^2 - 4})$$

where

$$a = R + \frac{2}{R}$$

It can be easily seen that there are positive constants  $c_1$  and  $c_2$  such that  $a^2 - 4 \geq c_1$  and  $\lambda_{\min}(\tilde{P}(t)) \geq c_2$ , for all  $t \geq 0$ , which shows that  $V(t, x)$  is positive definite.

(b)

$$\dot{V}(t, x) = -\frac{2}{C} \left[ 1 + \dot{R} \left( \frac{L}{R^2} - \frac{C}{2} \right) + \frac{L\dot{C}}{RC} - \frac{\dot{L}}{R} \right] x_1^2 - \frac{2}{L} \left( 1 + \frac{L\dot{R}}{R^2} \right) x_2^2$$

Suppose  $\dot{L}$ ,  $\dot{C}$ , and  $\dot{R}$  satisfy

$$1 + \dot{R} \left( \frac{L}{R^2} - \frac{C}{2} \right) + \frac{L\dot{C}}{RC} - \frac{\dot{L}}{R} \geq c_1$$

$$1 + \frac{L\dot{R}}{R^2} \geq c_2$$

for all  $t \geq 0$ , for some positive constants  $c_1$  and  $c_2$ . Then

$$\dot{V}(t, x) \leq -\frac{2c_1}{k_3} x_1^2 - \frac{2c_2}{k_1} x_2^2$$

Hence,  $\dot{V}(t, x)$  is negative definite. This shows that the origin is uniformly asymptotically stable. By linearity, it is exponentially stable. Alternatively, we can conclude that the origin is exponentially stable by noting that  $V(t, x)$  satisfies the conditions of Theorem 4.10.

### • 4.39

(a) Since  $g(t) \geq \alpha > a$ ,

$$1 + ag(t) - a^2 \geq 1 + a\alpha - a^2 > 1$$

Hence

$$V(t, x) \geq \frac{1}{2}(a \sin x_1 + x_2)^2 + 1 - \cos x_1$$

which shows that  $V$  is positive definite in the region  $|x_1| < 2\pi$ . Since  $g(t) \leq \beta$ ,

$$V(t, x) \leq \frac{1}{2}(a \sin x_1 + x_2)^2 + (1 + a\beta + a^2)|1 - \cos x_1|$$

which shows that  $V(t, x)$  is decrescent.

(b)

$$\begin{aligned} \dot{V} &= -[g(t) - a \cos x_1]x_2^2 - a \sin^2 x_1 - a^2(1 - \cos x_1)x_2 \sin x_1 + ag(t)(1 - \cos x_1) \\ &\leq -(\alpha - a)x_2^2 + a\gamma(1 - \cos x_1) - a \sin^2 x_1 + O(\|x\|^3) \\ &= -(\alpha - a)x_2^2 - a(2 - \gamma)(1 - \cos x_1) + a[2(1 - \cos x_1) - \sin^2 x_1] + O(\|x\|^3) \end{aligned}$$

The term  $[2(1 - \cos x_1) - \sin^2 x_1]$  is  $O(|x_1|^3)$ . Hence

$$\dot{V} \leq -(\alpha - a)x_2^2 - a(2 - \gamma)(1 - \cos x_1) + O(\|x\|^3)$$

(c) The preceding inequality shows that  $\dot{V}$  is negative definite, since near the origin the negative definite quadratic term dominates the cubic order term. Thus, the origin is uniformly asymptotically stable.

## 《非线性系统（第三版）》习题解答

• 4.40

(a)

$$\begin{aligned}
 P(t+T) &= \exp(Bt+BT)\Phi(0,t+T) \\
 &= \exp(Bt)\exp(BT)\Phi(0,T)\Phi(T,t+T) = \exp(Bt)\Phi(T,t+T)
 \end{aligned}$$

since  $\Phi(0,T) = [\Phi(T,0)]^{-1} = [\exp(BT)]^{-1}$ .

$$A(t+T) = A(t) \Rightarrow \Phi(T,t+T) = \Phi(0,t) \Rightarrow P(t+T) = \exp(Bt)\Phi(0,t) = P(t)$$

(b)

$$\begin{aligned}
 P^{-1}(t)\exp[(t-\tau)B]P(\tau) &= \Phi(t,0)\exp(-Bt)\exp(Bt-B\tau)\exp(B\tau)\Phi(0,\tau) \\
 &= \Phi(t,0)\Phi(0,\tau) = \Phi(t,\tau)
 \end{aligned}$$

(c)  $P(t)$  and  $P^{-1}(t)$  are continuous functions of  $t$ . Hence, they are bounded on  $[0, T]$ . Since they are periodic, they are bounded for all  $t \geq 0$ . Let  $\|P(t)\| \leq k_1$  and  $\|P^{-1}(t)\| \leq k_2$ . Then

$$\|\Phi(t,\tau)\| \leq k_1 k_2 \|\exp[(t-\tau)B]\|$$

and

$$\|\exp[(t-\tau)B]\| \leq k_1 k_2 \|\Phi(t,\tau)\|$$

Hence,  $\|\Phi(t,\tau)\|$  is bounded by  $ke^{-\gamma(t-\tau)}$  if and only if  $B$  is Hurwitz.

• 4.41

(a)

$$x_2 = 1 = \dot{x}_1$$

$$2x_1x_2 + 3t + 2 - 3x_1 - 2(t+1)x_2 = 2t + 3t + 2 - 3t - 2(t+1) = 0 = \dot{x}_2$$

Thus,  $x(t) = \begin{bmatrix} t \\ 1 \end{bmatrix}$  is a solution.

(b) Recall from the discussion at the beginning of Section 4.5 that to show asymptotic stability of a solution we shift it to the origin and then show asymptotic stability of the origin. Let  $z_1 = x_1 - t$  and  $z_2 = x_2 - 1$ . Then

$$\dot{z}_1 = z_2, \quad \dot{z}_2 = 2z_1z_2 - z_1 - 2z_2$$

We need to show that the origin  $z = 0$  is uniformly asymptotically stable.

$$\frac{\partial f}{\partial z} = \begin{bmatrix} 0 & 1 \\ -1 + 2z_2 & -2 + 2z_1 \end{bmatrix}, \quad A = \frac{\partial f}{\partial z} \Big|_{z=0} = \begin{bmatrix} 0 & 1 \\ -1 & -2 \end{bmatrix}$$

The matrix  $A$  is Hurwitz; hence, the origin is uniformly asymptotically stable.

• 4.42 Let  $V(x) = \frac{1}{2}x^T x$ .

$$\dot{V} = x^T \dot{x} = -a[x^T x + x^T S(x)x + (x^T x)^2] = -a(1 + x^T x)x^T x \leq -a x^T x$$

where we used the property  $x^T S(x)x = 0$ . By Theorem 4.10, the origin is globally exponentially stable.

• 4.43 The closed-loop system is  $\dot{x} = f(x) - \sigma G(x)G^T(x)Px$ . Use  $V(x) = x^T Px$  as a Lyapunov function candidate.

$$\dot{V} = 2x^T P\dot{x} = 2x^T Pf(x) - 2\sigma x^T PG(x)G^T(x)Px \leq -\gamma x^T Px - W(x) \leq -\gamma V(x)$$

By Theorem 4.10, the origin is globally exponentially stable.



## 《非线性系统（第三版）》习题解答

- 4.44 Let  $V(x) = \frac{1}{2}(x_1^2 + x_2^2)$ .

$$\begin{aligned}
 \dot{V} &= -x_1^2 + x_1x_2 + x_1(x_1^2 + x_2^2)\sin t - x_1x_2 - x_2^2 + x_2(x_1^2 + x_2^2)\cos t \\
 &= -(x_1^2 + x_2^2) + (x_1^2 + x_2^2)(x_1\sin t + x_2\cos t) \\
 &\leq -\|x\|_2^2 + \|x\|_2^3\sqrt{(\sin t)^2 + (\cos t)^2} = -\|x\|_2^2 + \|x\|_2^3 \\
 &\leq -(1-r)\|x\|_2^2, \quad \forall \|x\|_2 \leq r, \text{ for any } r < 1
 \end{aligned}$$

Hence, by Theorem 4.10, the origin is exponentially stable. Since  $V(x) = \frac{1}{2}\|x\|_2^2$ , the region of attraction can be estimated by the set  $\{\|x\|_2 \leq r\}$  for any  $r < 1$ .

- 4.45 (a) Use  $V(x) = \frac{1}{2}(x_1^2 + x_2^2)$  as a Lyapunov function candidate.

$$\dot{V} = x_1[h(t)x_2 - g(t)x_1^3] + x_2[-h(t)x_1 - g(t)x_2^3] = -g(t)(x_1^4 + x_2^4) \leq -k(x_1^4 + x_2^4)$$

Hence, the origin is uniformly asymptotically stable. Since all assumptions hold globally and  $V(x)$  is radially unbounded, the origin is globally uniformly asymptotically stable, which answers part (c).

(b) The conditions of Theorem 4.10 are not satisfied. Let us linearize the system

$$A(t) = \frac{\partial f}{\partial x}(t, 0) = \begin{bmatrix} 0 & h(t) \\ -h(t) & 0 \end{bmatrix}$$

Use  $V(x) = \frac{1}{2}(x_1^2 + x_2^2)$  as a Lyapunov function candidate for the linear system.

$$\dot{V} = x_1h(t)x_2 - x_2h(t)x_1 = 0$$

This shows that solutions starting on the surface  $V(x) = c$  remain on that surface for all  $t$ . Hence, the origin of the linear system is not exponentially stable. This implies that the origin of the nonlinear system is not exponentially stable.

(d) No.

- 4.46 Linearization at the origin yields the matrix

$$\left. \frac{\partial f}{\partial x} \right|_{x=0} = \begin{bmatrix} -1 + 3x_1^2 + x_2^2 & -1 + 2x_1x_2 \\ 1 + 2x_1x_2 & -1 + x_1^2 + 3x_2^2 \end{bmatrix}_{x=0} = \begin{bmatrix} -1 & -1 \\ 1 & -1 \end{bmatrix}$$

whose eigenvalues are  $-1 \pm j$ . Hence, the matrix is Hurwitz and the origin is exponentially stable. Consequently, it is asymptotically stable.

- 4.47 Let  $V(x) = \frac{1}{2}(bx_1^2 + ax_2^2)$ .

$$\dot{V} = -b\phi(t)(x_1 - ax_2)^2 - ac\psi(t)x_2^4 \leq -b\phi_0(x_1 - ax_2)^2 - ac\psi_0x_2^4 \stackrel{\text{def}}{=} -W_3(x)$$

It can be verified that  $W_3(x)$  is positive definite for all  $x$ . Hence, by Theorem 4.9, the origin is globally uniformly asymptotically stable. Linearization at the origin yields the linear system

$$\dot{y}_1 = -\phi(t)y_1 + a\phi(t)y_2, \quad \dot{y}_2 = b\phi(t)y_1 - ab\phi(t)y_2$$

The invertible change of variables

$$\begin{bmatrix} z_1 \\ z_2 \end{bmatrix} = \begin{bmatrix} b & 1 \\ 0 & 1 \end{bmatrix} \begin{bmatrix} y_1 \\ y_2 \end{bmatrix}$$

results in the system

$$\dot{z}_1 = 0, \quad \dot{z}_2 = \phi(t)z_1 - \phi(t)(1 + ab)z_2$$

which has the solution  $z_1(t) \equiv \text{constant}$ . This shows that the linear system is not exponentially stable. Therefore, the origin of the nonlinear system is not exponentially stable.

## 《非线性系统（第三版）》习题解答

• 4.48 Let  $A_1 = \frac{\partial f}{\partial x}(0)$  be the linearization of  $\dot{x} = f(x)$ . To find the linearization of  $\dot{x} = h(x)f(x)$ , set  $g(x) = h(x)f(x)$ . Then

$$\frac{\partial g_i}{\partial x_j} = h(x) \frac{\partial f_i}{\partial x_j} + \frac{\partial h}{\partial x_j} f_i(x)$$

Hence

$$\frac{\partial g_i}{\partial x_j}(0) = h(0) \frac{\partial f_i}{\partial x_j}(0) + \frac{\partial h}{\partial x_j}(0) f_i(0) = h(0) \frac{\partial f_i}{\partial x_j}(0)$$

Hence

$$A_2 = \frac{\partial g}{\partial x}(0) = h(0)A_1$$

Since  $h(0) > 0$ ,  $A_1$  is Hurwitz if and only if  $A_2$  is Hurwitz. By Theorem 4.15,

$$\dot{x} = f(x) \text{ is exp. stable} \Leftrightarrow A_1 \text{ is Hurwitz} \Leftrightarrow A_2 \text{ is Hurwitz} \Leftrightarrow \dot{x} = h(x)f(x) \text{ is exp. stable}$$

• 4.49 Equilibrium points:

$$\begin{aligned} 0 &= -a\bar{x}_1 + b \Rightarrow \bar{x}_1 = b/a \\ 0 &= -c\bar{x}_2 + \bar{x}_1(\alpha - \beta\bar{x}_1\bar{x}_2) \end{aligned}$$

Substituting  $\bar{x}_1 = b/a$  in the second equation, we obtain

$$\bar{x}_2 = \frac{\alpha b/a}{c + \beta(b/a)^2}$$

Thus the system has a unique equilibrium point at  $(\bar{x}_1, \bar{x}_2)$ . Let

$$y_1 = x_1 - \bar{x}_1, \quad y_2 = x_2 - \bar{x}_2$$

It can be verified that

$$\dot{y}_1 = -ay_1, \quad \dot{y}_2 = -[c + \beta(y_1 + \bar{x}_1)^2]y_2 + y_1\alpha - \beta\bar{x}_2 y_1^2 - 2\beta\bar{x}_1\bar{x}_2 y_1$$

Let

$$V = \frac{1}{2}y_1^2 + \frac{\gamma}{2}y_2^2 + \frac{1}{4}y_1^4, \quad \gamma > 0$$

$$\begin{aligned} \dot{V} &= -ay_1^2 - \gamma[c + \beta(y_1 + \bar{x}_1)^2]y_2^2 + \gamma(\alpha - 2\beta\bar{x}_1\bar{x}_2)y_1y_2 - \beta\gamma\bar{x}_2 y_1^2 y_2 - ay_1^4 \\ &\leq -ay_1^2 - \gamma c y_2^2 + \gamma c_1 |y_1| |y_2| + \gamma c_2 y_1^2 |y_2| - ay_1^4, \quad c_1 > 0, \quad c_2 > 0 \\ &= -\frac{a}{2}y_1^2 - \frac{\gamma c}{2}y_2^2 - \frac{a}{4}y_1^4 - \begin{bmatrix} |y_1| \\ |y_2| \end{bmatrix}^T Q_1 \begin{bmatrix} |y_1| \\ |y_2| \end{bmatrix} - \begin{bmatrix} |y_1|^2 \\ |y_2| \end{bmatrix}^T Q_2 \begin{bmatrix} |y_1|^2 \\ |y_2| \end{bmatrix} \end{aligned}$$

where

$$Q_1 = \begin{bmatrix} a/2 & -\gamma c_1/2 \\ -\gamma c_1/2 & \gamma c/4 \end{bmatrix}, \quad Q_2 = \begin{bmatrix} 3a/4 & -\gamma c_2/2 \\ -\gamma c_2/2 & \gamma c/4 \end{bmatrix}$$

Choosing  $\gamma < \min\{ac/2c_1^2, 3ac/4c_2^2\}$  ensures that  $Q_1$  and  $Q_2$  are positive definite. Then

$$\begin{aligned} \dot{V} &\leq -\frac{a}{2}y_1^2 - \frac{\gamma c}{2}y_2^2 - \frac{a}{4}y_1^4 \\ &\leq -\min\{a, c\} \left( \frac{1}{2}y_1^2 + \frac{\gamma}{2}y_2^2 + \frac{1}{4}y_1^4 \right) \\ &= -a_0 V, \quad a_0 = \min\{a, c\} \end{aligned}$$

which shows that the origin is globally exponentially stable.

## 《非线性系统（第三版）》习题解答

• 4.50

(a) Since the origin of the linearization is exponentially stable, by Theorem 4.13, the origin is exponentially stable. Therefore, there exist positive constants  $k_1$ ,  $\gamma$ , and  $c_1$  such that

$$\|x(t)\| \leq k_1 e^{-\gamma(t-t_0)} \|x(t_0)\|, \quad \forall \|x(t_0)\| \leq c_1$$

Suppose that  $c_1 < \|x(t_0)\| < c$ . Then

$$\|x(t)\| \leq \beta(\|x(t_0)\|, t - t_0)$$

Since  $\beta(\cdot, t)$  is a decreasing function of  $t$ , there is  $T > 0$  such that  $\beta(c, T - t_0) = c_1$ . Thus

$$\|x(t)\| \leq \begin{cases} \beta(\|x(t_0)\|, t - t_0), & \text{for } t_0 \leq t \leq T \\ \|x(T)\| k_1 e^{-\gamma(t-T)}, & \text{for } t > T \end{cases}$$

which implies that

$$\|x(t)\| \leq \beta(\|x(t_0)\|, 0) k_1 e^{\gamma(T-t_0)} e^{-\gamma(t-t_0)}, \quad \forall t \geq t_0, \forall c_1 < \|x(t_0)\| < c$$

Notice that the foregoing inequality is also valid for  $\|x(t_0)\| \leq c_1$  since  $\beta(\|x(t_0)\|, 0) \geq 1$ . Define

$$\alpha(r) = k_1 e^{\gamma(T-t_0)} \beta(r, 0)$$

Clearly,  $\alpha(\cdot)$  is a class  $\mathcal{K}$  function and

$$\|x(t)\| \leq \alpha(\|x(t_0)\|) e^{-\gamma(t-t_0)}, \quad \forall t \geq t_0, \forall \|x(t_0)\| < c$$

(b) Let  $M_1 = \max_{c_1 \leq r \leq c} \{\alpha(r)\}$ . Then,

$$\frac{\alpha(r)}{r} \leq \frac{M_1}{c_1}, \quad \forall c_1 \leq r \leq c$$

For  $\|x(t_0)\| \leq c_1$ , we have

$$\|x(t)\| \leq k_1 \|x(t_0)\| e^{-\gamma(t-t_0)}$$

For  $c_1 < \|x(t_0)\| < c$ , we have

$$\|x(t)\| \leq \alpha(\|x(t_0)\|) e^{-\gamma(t-t_0)} \leq \frac{M_1}{c_1} \|x(t_0)\| e^{-\gamma(t-t_0)}$$

Taking  $M = \max\{k_1, M_1/c_1\}$ , we obtain

$$\|x(t)\| \leq M \|x(t_0)\| e^{-\gamma(t-t_0)}, \quad \forall t \geq t_0, \forall \|x(t_0)\| < c$$

(c) The answer is no, because the constant  $M_1$  of part (b) depends on  $c$  and could approach  $\infty$  as  $c \rightarrow \infty$ .

• 4.51 Using the inequalities

$$k_1 \|x\|^a \leq V \leq k_2 \|x\|^a \quad \text{and} \quad \dot{V} \leq -k_3 \|x\|^a, \quad \forall \|x\| \geq \mu > 0$$

we see that as long as  $V \geq k_2 \mu^a$ , we have  $\|x\| \geq \mu$  and

$$\dot{V} \leq -\frac{k_3}{k_2} V \Rightarrow V(t, x(t)) \leq e^{-(k_3/k_2)(t-t_0)} V(t_0, x(t_0))$$

## 《非线性系统（第三版）》习题解答

Hence,

$$\begin{aligned}
 \|x(t)\| &\leq \left( \frac{V(t, x(t))}{k_1} \right)^{1/a} \leq \left( \frac{1}{k_1} e^{-(k_3/k_2)(t-t_0)} V(t_0, x(t_0)) \right)^{1/a} \\
 &\leq \left( \frac{1}{k_1} e^{-(k_3/k_2)(t-t_0)} k_2 \|x(t_0)\|^a \right)^{1/a} \\
 &= \left( \frac{k_2}{k_1} \right)^{1/a} e^{-(k_3/ak_2)(t-t_0)} \|x(t_0)\| = k e^{-\gamma(t-t_0)} \|x(t_0)\|
 \end{aligned}$$

The foregoing inequality will hold over the interval  $[t_0, t_0 + T]$  during which  $V \geq k_2 \mu^a$ . For  $t \geq t_0 + T$ , we have

$$\|x(t)\| \leq \left( \frac{V(t, x(t))}{k_1} \right)^{1/a} \leq \left( \frac{k_2 \mu^a}{k_1} \right)^{1/a} = k \mu$$

• 4.52 Let  $\varepsilon = \max_{W_4(x) \leq \mu} V(x)$ . The assumption  $\varepsilon < c$  ensures that  $\{W_4(x) \leq \mu\}$  is in the interior of  $\{V(x) \leq c\}$ . Hence,  $\dot{V}$  is negative on the boundary  $\{V(x) = c\}$  and the set  $\{V(x) \leq c\}$  is positively invariant. Let  $\Lambda = \{\varepsilon \leq V(x) \leq c\}$ . As argued on page 170 of the text, we can show that there is a finite  $T > 0$  such that for  $t_0 \leq t \leq t_0 + T$ ,  $x(t)$  will be in  $\Lambda$ , while for  $t \geq t_0 + T$ , it will be in  $\{V(x) \leq \varepsilon\}$ . Hence, in  $[t_0, t_0 + T]$ ,  $x(t)$  satisfies inequality (4.42). For  $t \geq t_0 + T$ ,  $x(t) \in \{V(x) \leq \varepsilon\}$ . Since positive definite functions are bounded from below and above by class  $\mathcal{K}$  functions (Lemma 4.3), any  $x$  in  $\{V(x) \leq \varepsilon\}$  can be bounded by a class  $\mathcal{K}$  function of  $\mu$ . In general, the function will not be  $\alpha_1^{-1}(\alpha_2(\mu))$  as in (4.43).

• 4.53 The proof is exactly the same as that of Theorem 4.18. Notice that the argument used in the proof of Theorem 4.18 holds outside a ball that contains the origin.

• 4.54 (1) The system is not input-to-state stable since with  $u(t) \equiv c > 1$  and  $x(0) > 0$ ,  $x(t) \rightarrow \infty$  as  $t \rightarrow \infty$ .

(2) Let  $V(x) = \frac{1}{2}x^2$ .

$$\dot{V} = -x^4 + ux^4 - x^6 \leq -x^4, \quad \forall |x| \geq \sqrt{u}$$

By Theorem 4.19, the system is input-to-state stable.

(3) The system is not input-to-state stable since with  $u(t) \equiv 1$  and  $x(0) > 0$ ,  $x(t) \rightarrow \infty$  as  $t \rightarrow \infty$ .

(4) With  $u = 0$ , the origin of  $\dot{x} = x - x^3$  is unstable. Hence, the system is not input-to-state stable.

• 4.55 (1) Take  $V = \frac{1}{2}(x_1^2 + x_2^2)$ .

$$\begin{aligned}
 \dot{V} &= -(x_1^2 + x_2^2) + x_2 u \leq -\|x\|_2^2 + \|x\|_2 |u| \\
 &= -(1 - \theta)\|x\|_2^2 - \theta\|x\|_2^2 + \|x\|_2 |u| \leq -(1 - \theta)\|x\|_2^2, \quad \forall \|x\|_2 \geq |u|/\theta
 \end{aligned}$$

where  $0 < \theta < 1$ . Hence, the system is input-to-state stable.

(2) Take  $V = (1/4)x_1^4 + (1/2)x_2^2$ .

$$\dot{V} = -x_1^4 - x_2^2 + x_2 u = -x_1^4 - (1 - \theta)x_2^2 - \theta x_2^2 + x_2 u \leq -x_1^4 - (1 - \theta)x_2^2, \quad \text{for } |x_2| \geq |u|/\theta$$

where  $0 < \theta < 1$ . When  $|x_2| \leq |u|/\theta$ , we have

$$\dot{V} \leq -(1 - \theta)x_1^4 - \theta x_1^4 - x_2^2 + u^2/\theta \leq -(1 - \theta)x_1^4 - x_2^2, \quad \text{for } |x_1| \geq \sqrt{|u|/\theta}$$

## 《非线性系统（第三版）》习题解答

Thus,  $\dot{V} \leq -(1-\theta)[x_1^4 + x_2^2]$  for all  $\|x\|_\infty \geq \rho(|u|)$ , where  $\rho(r) = \max\{r/\theta, \sqrt{r/\theta}\}$ . Hence, the system is input-to-state stable.

(3) Take  $V = x_1^2 + 2x_1x_2 + 2x_2^2 + x_1^4$ .

$$\dot{V} = -2x_1^4 - 2x_2^2 + 2x_1u + 4x_2u \leq -2x_1^4 - 2x_2^2 + 2|x_1||u| + 4|x_2||u|$$

We have

$$4|x_2||u| = 2|x_2||2u| \leq |x_2|^2 + |2u|^2$$

Using Young's inequality, we have

$$2|x_1||u| = |x_1||2u| \leq |x_1|^4 + (2|u|)^{4/3}$$

Thus

$$\dot{V} \leq -x_1^4 - x_2^2 + (2|u|)^{4/3} + 4|u|^2$$

Define the class  $\mathcal{K}$  function  $\phi(r) = (2r)^{4/3} + 4r^2$ . Then,

$$\dot{V} \leq -x_1^4 - x_2^2 + \phi(|u|)$$

Since  $x_1^4 + x_2^2$  is positive definite and radially unbounded, by Lemma 4.3, there exists a class  $\mathcal{K}_\infty$  function  $\alpha_3$  such that

$$\dot{V} \leq -\alpha_3(\|x\|) + \psi(|u|) = -(1-\theta)\alpha_3(\|x\|) - \theta\alpha_3(\|x\|) + \psi(|u|) \leq -(1-\theta)\alpha_3(\|x\|), \quad \forall |x| \geq \alpha_3^{-1}\left(\frac{\phi(|u|)}{\theta}\right)$$

where  $0 < \theta < 1$ . It follows from Theorem 4.19 that the system is input-to-state stable.

(4) With  $u = 0$ , the system

$$\dot{x}_1 = (x_1 - x_2)(x_1^2 - 1), \quad \dot{x}_2 = (x_1 + x_2)(x_1^2 - 1)$$

has an equilibrium set  $\{x_1^2 = 1\}$ . Hence, the origin is not globally asymptotically stable. It follows that the system is not input-to-state stable.

(5) The unforced system (with  $u = 0$ ) has equilibrium points at  $(0, 0)$ ,  $(1, 1)$  and  $(-1, -1)$ . Hence, the origin is not globally asymptotically stable. Consequently, the system is not input-to-state stable.

(6) Let  $V(x) = \frac{1}{2}(x_1^2 + x_2^2)$ .

$$\begin{aligned} \dot{V} &= -x_1^2 - x_1x_2 + x_1u_1 + x_1x_2 - x_2^2 + x_2u_2 \\ &= -x_1^2 - x_2^2 + x_1u_1 + x_2u_2 \\ &\leq -(1-\theta)x_1^2 - (1-\theta)x_2^2 - \theta x_1^2 - \theta x_2^2 + |x_1||u|_\infty + |x_2||u|_\infty, \quad 0 < \theta < 1 \\ &\leq -(1-\theta)x_1^2 - (1-\theta)x_2^2, \quad \text{for } |x_1| \geq \frac{\|u\|_\infty}{\theta} \text{ and } |x_2| \geq \left(\frac{\|u\|_\infty}{\theta}\right)^{1/3} \end{aligned}$$

For  $|x_2| < (\|u\|_\infty/\theta)^{1/3}$ , we have

$$\begin{aligned} \dot{V} &\leq -x_1^2 - x_2^2 + |x_1||u|_\infty + \frac{(\|u\|_\infty)^{4/3}}{\theta^{1/3}} \\ &= -(1-\theta)x_1^2 - x_2^2 - \theta x_1^2 + |x_1||u|_\infty + \frac{(\|u\|_\infty)^{4/3}}{\theta^{1/3}} \end{aligned}$$

Let  $\rho_1(r)$  be the largest positive real root of the polynomial equation

$$-\theta y^2 + ry + \frac{r^{4/3}}{\theta^{1/3}} = 0, \quad r \geq 0$$

## 《非线性系统（第三版）》习题解答

It can be seen that  $\rho_1(r)$  is a class  $\mathcal{K}_\infty$  function of  $r$  and  $\rho_1(r) \geq r/\theta$ . Hence, for  $|x_2| < (\|u\|_\infty/\theta)^{1/3}$ , we have

$$\dot{V} \leq -(1-\theta)x_1^2 - x_2^4, \quad \text{for } |x_1| \geq \rho_1(\|u\|_\infty)$$

For  $|x_1| < \|u\|_\infty/\theta$ , we have

$$\begin{aligned} \dot{V} &\leq -x_1^2 - x_2^4 + \frac{\|u\|_\infty^2}{\theta} + |x_2| \|u\|_\infty \\ &= -x_1^2 - (1-\theta)x_2^4 - \theta x_2^4 + |x_2| \|u\|_\infty + \frac{\|u\|_\infty^2}{\theta} \end{aligned}$$

Let  $\rho_2(r)$  be the largest positive real root of the polynomial equation

$$-\theta y^4 + ry + \frac{r^2}{\theta} = 0, \quad r \geq 0$$

It can be seen that  $\rho_2(r)$  is a class  $\mathcal{K}_\infty$  function of  $r$  and  $\rho_2(r) \geq (r/\theta)^{1/3}$ . Hence, for  $|x_1| < \|u\|_\infty/\theta$ , we have

$$\dot{V} \leq -x_1^2 - (1-\theta)x_2^4, \quad \text{for } |x_2| \geq \rho_2(\|u\|_\infty)$$

Define  $\rho(r) = \max\{\rho_1(r), \rho_2(r)\}$ . Then,  $\rho(r)$  is a class  $\mathcal{K}_\infty$  function of  $r$  and

$$\dot{V} \leq -(1-\theta)x_1^2 - (1-\theta)x_2^4, \quad \forall \|x\|_\infty \geq \rho(\|u\|_\infty)$$

From Theorem 4.19, we conclude that the system is input-to-state stable.

(7) Let  $V(x) = \frac{1}{2}x_1^2 + \int_0^{x_1} \sigma(y) dy + \frac{1}{2}x_2^2$ .

$$\begin{aligned} \dot{V} &= [x_1 + \sigma(x_1)](-x_1 + x_2) + x_2[-x_1 - \sigma(x_1) - x_2 + u] \\ &= -x_1^2 - x_1\sigma(x_1) - x_2^2 + x_2u \leq -\|x\|_2^2 + \|x\|_2|u| \leq -(1-\theta)\|x\|_2, \quad \forall \|x\|_2 \geq |u|/\theta \end{aligned}$$

where  $0 < \theta < 1$ . From Theorem 4.19, we conclude that the system is input-to-state stable.

• 4.56 The system  $\dot{x}_1 = -x_1^3 + x_2$ , with  $x_2$  as input, is input-to-state stable. The system  $\dot{x}_2 = -x_2^3$  has an asymptotically stable equilibrium point at the origin. It follows from Lemma 4.7 that the origin of the full system is globally asymptotically stable.

• 4.57  $\psi(u) \leq |\psi(u)|$ , where  $|\psi(u)|$  is continuous and positive definite. It follows from Lemma 4.3 that there is a class  $\mathcal{K}$  function  $\phi$  such that  $|\psi(u)| \leq \phi(\|u\|)$ . Hence

$$\begin{aligned} \dot{V} &\leq -(1-\theta)\alpha_3(\|x\|) - \theta\alpha_3(\|x\|) + \phi(\|u\|), \quad 0 < \theta < 1 \\ &\leq -(1-\theta)\alpha_3(\|x\|), \quad \forall \|x\| \geq \alpha_3^{-1}\left(\frac{\phi(\|u\|)}{\theta}\right) \end{aligned}$$

Now we can apply Theorem 4.19 to conclude that the system is input-to-state stable.

• 4.58 Given  $\varepsilon > 0$ , find  $\varepsilon_1 > 0$  such that  $\gamma(\varepsilon_1) \leq \varepsilon/2$ . Since  $\lim_{t \rightarrow \infty} u(t) = 0$ , given  $\varepsilon_1$  there is  $T_1 > 0$  such that  $\|u(t)\| \leq \varepsilon_1$  for all  $t \geq T_1$ . Take  $t_0 \geq T_1$ . For  $t \geq t_0$ , we have

$$\|x(t)\| \leq \beta(\|x(t_0)\|, t - t_0) + \gamma(\varepsilon_1) \leq \beta(c, t - t_0) + \varepsilon/2$$

for some  $c > 0$ , where we used the fact that  $x(t)$  is bounded. Since  $\beta(c, t - t_0) \rightarrow 0$  as  $t \rightarrow \infty$ , there is  $T_2 > 0$  such that  $\beta(c, t - t_0) \leq \varepsilon/2$  for all  $t \geq T_2$ . Thus,

$$\|x(t)\| \leq \varepsilon, \quad \forall t \geq T = \max\{T_1, T_2\}$$

which shows that  $\lim_{t \rightarrow \infty} x(t) = 0$ .

## 《非线性系统（第三版）》习题解答

- 4.59 It follows from Exercise 4.58, but an independent solution is given next. Let  $V(x) = \frac{1}{4}x^4$ .

$$\dot{V} = -x^6 + x^3 e^{-t}$$

Starting from any time  $t_0$ , we have  $e^{-t} \leq e^{-t_0}$  for all  $t \geq t_0$ . Hence

$$\dot{V} \leq -x^6 + |x|^3 e^{-t_0} \leq -(1 - \theta)x^6, \quad \forall |x| \geq \left(\frac{e^{-t_0}}{\theta}\right)^{1/3}$$

where  $0 < \theta < 1$ . It follows from Theorem 4.18 that there is a finite time  $t_1 \geq t_0$  such that

$$\|x(t)\| \leq \left(\frac{e^{-t_0}}{\theta}\right)^{1/3}, \quad \forall t \geq t_1$$

Given  $0 < \epsilon < 1$ , take  $t_0 = \ln(1/\theta\epsilon^3)$ . Then there exists a finite time  $T$  such that  $\|x(t)\| \leq \epsilon$  for all  $t \geq T$ . This shows that  $x(t)$  converges to zero as  $t$  tends to infinity.

- 4.60 Applying the non-global version of Theorem 4.18 shows that for any  $x(t_0)$  and any input  $u(t)$  such that

$$\|x(t_0)\| < \alpha_2^{-1}(\alpha_1(r)), \quad \rho(\sup_{t \geq t_0} \|u(t)\|) < \min\{\alpha_2^{-1}(\alpha_1(r)), \rho(r_u)\}$$

the solution  $x(t)$  exists and satisfies

$$\|x(t)\| \leq \beta(\|x(t_0)\|, t - t_0) + \gamma\left(\sup_{\tau \geq t_0} \|u(\tau)\|\right), \quad \forall t \geq t_0$$

Since the solution  $x(t)$  depends only on  $u(\tau)$  for  $t_0 \leq \tau \leq t$ , the supremum on the right-hand side can be taken over  $[t_0, t]$ , which yields (4.47).

- 4.61

(a) Asymptotic stability can be shown by linearization which yields the Hurwitz matrix  $[\partial f / \partial x](0) = -I$ . Global asymptotic stability can be shown as follows. First we note that there is no finite escape time because  $\|f(x)\| \leq k\|x\|$ ; see Exercise 3.6. We have  $x_2(t) = e^{-t}x_2(0)$ . Therefore, there exists a finite time  $T > 0$  such that

$$\left[\sin\left(\frac{\pi x_2}{2}\right)\right]^2 \leq \beta < 1, \quad \forall t \geq T$$

Consequently

$$x_1 \dot{x}_1 \leq -(1 - \beta)x_1^2, \quad \forall t \geq T \Rightarrow x_1(t) \rightarrow 0 \text{ as } t \rightarrow \infty$$

- (b) The linear system  $\dot{x}_2 = -x_2 + u$  is input-to-state stable. Hence, for any bounded  $u(t)$ ,  $x_2(t)$  is bounded.

$$x_1(t) = x_1(0) + \int_0^t x_1(\tau) \left[ \left(\sin \frac{\pi x_2(\tau)}{2}\right)^2 - 1 \right] d\tau$$

$$|x_1(t)| \leq |x_1(0)| + \int_0^t |x_1(\tau)| d\tau$$

By Gronwall-Bellman inequality

$$|x_1(t)| \leq |x_1(0)|e^t$$

Let  $T$  be as defined in part (a).

$$x_1 \dot{x}_1 \leq -(1 - \beta)x_1^2, \quad \forall t \geq T \Rightarrow |x_1(t)| \leq |x_1(T)|, \quad \forall t \geq T \Rightarrow |x_1(t)| \leq |x_1(0)|e^T, \quad \forall t \geq 0$$

## 《非线性系统（第三版）》习题解答

which shows that  $x_1(t)$  is bounded.

(c) With  $u(t) \equiv 1$  and  $x_2(0) = 1$ , we have  $x_2(t) \equiv 1$ . Then

$$\dot{x}_1 = x_1 \left[ \left( \sin \frac{\pi}{2} \right)^2 - 1 \right] = 0 \Rightarrow x_1(t) \equiv x_1(0) = a$$

(d) Suppose the system is input-to-state stable, then there exist a class  $\mathcal{KL}$  function  $\beta$  and a class  $\mathcal{K}$  function  $\gamma$  such that

$$\|x(t)\| \leq \beta(\|x(0)\|, t) + \gamma \left( \sup_{t \geq 0} \|u(t)\| \right), \quad \forall t \geq 0$$

Applying this inequality to the solution of part (c), we obtain

$$\|x(t)\| \leq \beta(\|x(0)\|, t) + \gamma(1), \quad \forall t \geq 0$$

Since  $\beta(\|x(0)\|, t)$  tends to zero as  $t$  tends to infinity, there exists a finite time  $T_1$  such that

$$\|x(t)\| \leq 2\gamma(1), \quad \forall t \geq T_1$$

But  $\|x(t)\|_2 \equiv \sqrt{a^2 + 1}$  can be made arbitrarily large by choosing  $a$  large enough. This is a contradiction. hence, the system is not input-to-state stable.

• 4.62 The equilibrium point  $x = 0$  of  $x(k+1) = f(x(k))$  is

- stable, if for each  $\varepsilon > 0$ , there is  $\delta > 0$  such that

$$\|x(0)\| < \delta \Rightarrow \|x(k)\| < \varepsilon, \quad \forall k \geq 0$$

- unstable, if not stable.
- asymptotically stable, if stable and  $\delta$  can be chosen such that

$$\|x(0)\| < \delta \Rightarrow \lim_{k \rightarrow \infty} x(k) = 0$$

• 4.63 The proof proceeds exactly as in the proofs of Theorems 4.1 and 4.2.

• 4.64 Since  $\Delta V \leq -c_3 \|x\|^2 \leq -(c_3/c_2)V$ ,  $V_k \stackrel{\text{def}}{=} V(x(k))$  satisfies the inequality  $V_{k+1} - V_k \leq -(c_3/c_2)V_k$ . By applying this inequality recursively, it can be shown that  $V_k \leq \left(1 - \frac{c_3}{c_2}\right)^k V_0$ . It can be seen that the constant  $(c_3/c_2) < 1$ , for if this was not the case  $V_k$  would go negative which is impossible. Therefore,  $\left(1 - \frac{c_3}{c_2}\right) < 1$ . Now

$$\|x(k)\| \leq \left( \frac{V(x(k))}{c_1} \right)^{1/c} \leq \left[ \frac{1}{c_1} \left(1 - \frac{c_3}{c_2}\right)^k c_2 \|x(0)\|^c \right]^{1/c} = \left( \frac{c_2}{c_1} \right)^{1/c} \left(1 - \frac{c_3}{c_2}\right)^{k/c} \|x(0)\|$$

Set  $\alpha = \left(\frac{c_2}{c_1}\right)^{1/c}$  and  $\gamma = \left(1 - \frac{c_3}{c_2}\right)^{1/c}$  to obtain  $\|x(k)\| \leq \alpha \|x(0)\| \gamma^k$ , where  $\alpha \geq 1$  and  $0 < \gamma < 1$ . The origin will be globally exponentially stable if the inequalities satisfied by  $V$  and  $\Delta V$  hold globally.

• 4.65 The proof proceeds as in the proof of LaSalle's theorem (Theorem 4.4).



## 《非线性系统（第三版）》习题解答

• 4.66

(3)  $\Rightarrow$  (1) Consider the Lyapunov function candidate  $V(x) = x^T P x$ . Then

$$\Delta V(x) = x^T (A^T P A - P)x = -x^T Q x < 0, \forall x \neq 0$$

Hence, the origin is asymptotically stable.

(1)  $\Leftrightarrow$  (2) The solution of the state equation is

$$x(k) = A^k x(0) = M J^k M^{-1} x(0)$$

where

$$J = \text{block diag}[J_1, J_2, \dots, J_N]$$

is the Jordan form of  $A$ . If  $J_i = \lambda_i$ , then

$$J_i^k = \lambda_i^k \rightarrow 0, \text{ as } k \rightarrow \infty \iff |\lambda_i| < 1$$

If  $J_i = \lambda_i I + N$ , where  $N$  is a Nilpotent matrix, then

$$J_i^k = (\lambda_i I + N)^k = \sum_{l=0}^k \binom{k}{l} \lambda_i^k N^{k-l} \rightarrow 0, \text{ as } k \rightarrow \infty \iff |\lambda_i| < 1$$

Thus

$$x(k) = A^k x(0) = M J^k M^{-1} x(0) \rightarrow 0, \text{ as } k \rightarrow \infty \iff |\lambda_i| < 1$$

for all eigenvalues of  $A$ .

(2)  $\Rightarrow$  (3) Let

$$P = \sum_{k=0}^{\infty} (A^k)^T Q (A^k)$$

From (2),  $\|A\| \leq C\gamma^k$ , for  $0 < \gamma < 1$  and  $C > 0$ . Therefore

$$\|P\| \leq \sum_{k=0}^{\infty} \|Q\| \|A\|^{2k} \leq \sum_{k=0}^{\infty} \|Q\| C^2 \gamma^{2k} \leq \frac{\|Q\| C^2}{1 - \gamma^2}$$

Hence, the infinite summation exists. On the other hand

$$V(x) = x^T P x = x^T Q x + x \left[ \sum_{k=1}^{\infty} (A^k)^T Q (A^k) \right] x \geq x^T Q x$$

Hence,  $P$  is positive definite. Now

$$\begin{aligned} A^T P A - P &= \sum_{k=0}^{\infty} (A^{k+1})^T Q (A^{k+1}) - \sum_{k=0}^{\infty} (A^k)^T Q (A^k) \\ &= \sum_{r=1}^{\infty} (A^r)^T Q (A^r) - \sum_{k=0}^{\infty} (A^k)^T Q (A^k) = Q \end{aligned}$$

• 4.67 Suppose the eigenvalues of  $A$  have magnitudes less than one, and let  $P$  be the solution of  $A^T P A - P = -Q$ , where  $Q = Q^T > 0$ . It follows from the previous exercise that  $P = P^T > 0$ . Take  $V(x) = x^T P x$  as a Lyapunov function candidate.

$$\begin{aligned} \Delta V(x) &= V(f(x)) - V(x) = f^T(x) P f(x) - x^T P x \\ &= [Ax + g(x)]^T P [Ax + g(x)] - x^T P x \\ &= -x^T Q x + 2g^T(x) P A x + g^T(x) P g(x) \end{aligned}$$

## 《非线性系统（第三版）》习题解答

Given  $\gamma > 0$ , there is  $r > 0$  such that  $\|g(x)\|_2 \leq \gamma\|x\|_2$  for all  $\|x\|_2 \leq r$ . Hence,

$$\Delta V(x) \leq -\lambda_{\min}(Q)\|x\|_2^2 + 2\gamma\|PA\|_2\|x\|_2^2 + \gamma^2\|P\|_2\|x\|_2^2$$

Choose  $\gamma$  small enough that

$$2\gamma\|PA\|_2 + \gamma^2\|P\|_2 \leq \frac{1}{2}\lambda_{\min}(Q)$$

Then

$$\Delta V(x) \leq -\frac{1}{2}\lambda_{\min}(Q)\|x\|_2^2$$

which shows that the origin is asymptotically stable.

• 4.68 Let  $\phi(k, x)$  be the solution of  $x(k+1) = f(x(k))$  that starts at  $x$  at time  $k=0$ . Let

$$V(x) = \sum_{k=0}^{N-1} \phi^T(k, x)\phi(k, x)$$

Then

$$V(x) = x^T x + \sum_{k=1}^{N-1} \phi^T(k, x)\phi(k, x) \geq x^T x$$

On the other hand

$$V(x) \leq \sum_{k=0}^{N-1} C^2 \gamma^{2k} \|x\|_2^2 \leq C^2 \left( \frac{1 - \gamma^{2N}}{1 - \gamma^2} \right) \|x\|_2^2$$

Thus, the first inequality is satisfied with  $c_1 = 1$  and  $c_2 = C^2(1 - \gamma^{2N})/(1 - \gamma^2)$ .

$$\begin{aligned} \Delta V(x) &= V(f(x)) - V(x) = \sum_{k=0}^{N-1} \phi^T(k+1, x)\phi(k+1, x) - \sum_{k=0}^{N-1} \phi^T(k, x)\phi(k, x) \\ &= \sum_{j=1}^N \phi^T(j, x)\phi(j, x) - \sum_{k=0}^{N-1} \phi^T(k, x)\phi(k, x) = \phi^T(N, x)\phi(N, x) - x^T x \\ &\leq C^2 \gamma^{2N} \|x\|_2^2 - \|x\|_2^2 = -(1 - C^2 \gamma^{2N}) \|x\|_2^2 \end{aligned}$$

where we have used the fact that

$$\phi(k, f(x)) = \phi(k, \phi(1, x)) = \phi(k+1, x)$$

Choose  $N$  large enough to ensure that  $1 - C^2 \gamma^{2N} > 0$ . Thus, the second inequality is satisfied with  $c_3 = 1 - C^2 \gamma^{2N} > 0$ . Finally, from the continuous differentiability of  $f(x)$  we know that  $f(x)$  is Lipschitz over the bounded domain  $D$ . Let  $L$  be a Lipschitz constant such that

$$\|f(x) - f(y)\|_2 \leq L\|x - y\|_2$$

Then

$$\|\phi(k+1, x) - \phi(k+1, y)\|_2 = \|f(\phi(k, x)) - f(\phi(k, y))\|_2 \leq L\|\phi(k, x) - \phi(k, y)\|_2$$

and by induction we obtain

$$\|\phi(k, x) - \phi(k, y)\|_2 \leq L^k \|x - y\|_2$$

## 《非线性系统（第三版）》习题解答

Consider

$$\begin{aligned}
 |V(x) - V(y)| &= \left| \sum_{k=0}^{N-1} [\phi^T(k, x)\phi(k, x) - \phi^T(k, y)\phi(k, y)] \right| \\
 &= \left| \sum_{k=0}^{N-1} \{ \phi^T(k, x) [\phi(k, x) - \phi(k, y)] + \phi^T(k, y) [\phi(k, x) - \phi(k, y)] \} \right| \\
 &\leq \sum_{k=0}^{N-1} [ \|\phi(k, x)\|_2 \|\phi(k, x) - \phi(k, y)\|_2 + \|\phi(k, y)\|_2 \|\phi(k, x) - \phi(k, y)\|_2 ] \\
 &\leq \sum_{k=0}^{N-1} [ \|\phi(k, x)\|_2 + \|\phi(k, y)\|_2 ] L^k \|x - y\|_2 \\
 &\leq \sum_{k=0}^{N-1} (C\gamma^k \|x\|_2 + C\gamma^k \|y\|_2) L^k \|x - y\|_2 \leq \left( \sum_{k=0}^{N-1} C\gamma^k L^k \right) (\|x\|_2 + \|y\|_2) \|x - y\|_2
 \end{aligned}$$

Thus the last inequality is satisfied with  $c_4 = \left( \sum_{k=0}^{N-1} C\gamma^k L^k \right)$ .

## 《非线性系统（第三版）》习题解答

---

Controlengineers.ir

## 《非线性系统（第三版）》习题解答

### Chapter 5

• 5.1 Let  $(u_1, y_1)$  and  $(u_2, y_2)$  be the input-output pairs of the two systems. We have  $u = u_1$ ,  $y = y_2$ ,  $u_2 = y_1$ , and

$$\|y_{i\tau}\|_{\mathcal{L}} \leq \alpha_i (\|u_{i\tau}\|_{\mathcal{L}}) + \beta_i, \quad i = 1, 2$$

Then

$$\begin{aligned} \|y_{2\tau}\|_{\mathcal{L}} &\leq \alpha_2 (\|y_{1\tau}\|_{\mathcal{L}}) + \beta_2 \\ &\leq \alpha_2 (\alpha_1 (\|u_{1\tau}\|_{\mathcal{L}}) + \beta_1) + \beta_2 \\ &\leq \alpha_2 (2\alpha_1 (\|u_{1\tau}\|_{\mathcal{L}})) + \alpha_2 (2\beta_1) + \beta_2 \end{aligned}$$

where we have used Exercise 4.35. Set  $\alpha = \alpha_2 \circ 2\alpha_1$  and  $\beta = \alpha_2 (2\beta_1) + \beta_2$ , to obtain

$$\|y_{\tau}\|_{\mathcal{L}} \leq \alpha (\|u_{\tau}\|_{\mathcal{L}}) + \beta$$

To show finite-gain  $\mathcal{L}$  stability, start from

$$\|y_{i\tau}\|_{\mathcal{L}} \leq \gamma_i \|u_{i\tau}\|_{\mathcal{L}} + \beta_i, \quad i = 1, 2$$

In this case

$$\|y_{2\tau}\|_{\mathcal{L}} \leq \gamma_2 [\gamma_1 \|u_{1\tau}\|_{\mathcal{L}} + \beta_1] + \beta_2 \leq \gamma_1 \gamma_2 \|u_{1\tau}\|_{\mathcal{L}} + \gamma_2 \beta_1 + \beta_2$$

Set  $\gamma = \gamma_1 \gamma_2$  and  $\beta = \gamma_2 \beta_1 + \beta_2$ , to obtain

$$\|y_{\tau}\|_{\mathcal{L}} \leq \gamma \|u_{\tau}\|_{\mathcal{L}} + \beta$$

• 5.2 Let  $(u_1, y_1)$  and  $(u_2, y_2)$  be the input-output pairs of the two systems. We have  $u_1 = u_2 = u$ ,  $y = y_1 + y_2$ , and

$$\|y_{i\tau}\|_{\mathcal{L}} \leq \alpha_i (\|u_{i\tau}\|_{\mathcal{L}}) + \beta_i, \quad i = 1, 2$$

Then

$$\|y_{\tau}\|_{\mathcal{L}} \leq \|y_{1\tau}\|_{\mathcal{L}} + \|y_{2\tau}\|_{\mathcal{L}} \leq \alpha_1 (\|u_{\tau}\|_{\mathcal{L}}) + \beta_1 + \alpha_2 (\|u_{\tau}\|_{\mathcal{L}}) + \beta_2$$

Set  $\alpha = \alpha_1 + \alpha_2$  and  $\beta = \beta_1 + \beta_2$ , to obtain

$$\|y_{\tau}\|_{\mathcal{L}} \leq \alpha (\|u_{\tau}\|_{\mathcal{L}}) + \beta$$

To show finite-gain  $\mathcal{L}$  stability, start from

$$\|y_{i\tau}\|_{\mathcal{L}} \leq \gamma_i \|u_{i\tau}\|_{\mathcal{L}} + \beta_i, \quad i = 1, 2$$

In this case

$$\|y_{\tau}\|_{\mathcal{L}} \leq \gamma_1 \|u_{\tau}\|_{\mathcal{L}} + \beta_1 + \gamma_2 \|u_{\tau}\|_{\mathcal{L}} + \beta_2$$

Set  $\gamma = \gamma_1 + \gamma_2$  and  $\beta = \beta_1 + \beta_2$ , to obtain

$$\|y_{\tau}\|_{\mathcal{L}} \leq \gamma \|u_{\tau}\|_{\mathcal{L}} + \beta$$

## 《非线性系统（第三版）》习题解答

• 5.3

(a) Let  $\alpha(r) = r^{1/3}$ ;  $\alpha$  is a class  $\mathcal{K}_\infty$  function. We have

$$|y| \leq |u|^{1/3} \Rightarrow \|y_\tau\|_{\mathcal{L}_\infty} \leq (\|u_\tau\|_{\mathcal{L}_\infty})^{1/3} \Rightarrow \|y_\tau\|_{\mathcal{L}_\infty} \leq \alpha(\|u_\tau\|_{\mathcal{L}_\infty})$$

Hence, the system is  $\mathcal{L}_\infty$  stable with zero bias.

(b) The two curves  $|y| = |u|^{1/3}$  and  $|y| = a|u|$  intersect at the point  $|u| = (1/a)^{3/2}$ . Therefore, for  $|u| \leq (1/a)^{3/2}$  we have  $|y| \leq (1/a)^{1/2}$ , while for  $|u| > (1/a)^{3/2}$  we have  $|y| \leq a|u|$ . Thus,

$$|y| \leq a|u| + (1/a)^{1/2}, \quad \forall |u| \geq 0$$

Setting  $\gamma = a$  and  $\beta = (1/a)^{1/2}$ , we obtain

$$\|y_\tau\|_{\mathcal{L}_\infty} \leq \gamma \|u_\tau\|_{\mathcal{L}_\infty} + \beta$$

(c) To show finite-gain stability, we must use nonzero bias. This example shows that a nonzero bias term may be used to achieve finite-gain stability in situations where it is not possible to have finite-gain stability with zero bias.

• 5.4

(1)  $h(0) = 0 \Rightarrow |h(u)| \leq L|u|, \forall u$ . For  $p = \infty$ , we have

$$\sup_{t \geq 0} |y(t)| \leq L \sup_{t \geq 0} |u(t)|$$

which shows that the system is finite-gain  $\mathcal{L}_\infty$  stable with zero bias. For  $p \in [1, \infty)$ , we have

$$\int_0^\tau |y(t)|^p dt \leq L^p \int_0^\tau |u(t)|^p dt \Rightarrow \|y_\tau\|_{\mathcal{L}_p} \leq L \|u_\tau\|_{\mathcal{L}_p}$$

Hence, for each  $p \in [1, \infty)$ , the system is finite-gain  $\mathcal{L}_p$  stable with zero bias.

(2) Let  $|h(0)| = k > 0$ . Then,  $|h(u)| \leq L|u| + k$ . For  $p = \infty$ , we have

$$\sup_{t \geq 0} |y(t)| \leq L \sup_{t \geq 0} |u(t)| + k$$

which shows that the system is finite-gain  $\mathcal{L}_\infty$  stable. For  $p \in [1, \infty)$ , the integral  $\int_0^\tau (L|u(t)| + k)^p dt$  diverges as  $\tau \rightarrow \infty$ . The system is not  $\mathcal{L}_p$  stable for  $p \in [1, \infty)$ , as it can be seen by taking  $u(t) \equiv 0$ .

• 5.5 The relay characteristics of parts (a), (b), and (d) satisfy  $|y(t)| \leq k|u(t)|$  for some  $k > 0$ . Therefore,  $\sup_{t \geq 0} |y(t)| \leq k \sup_{t \geq 0} |u(t)|$  and  $\int_0^\infty y^2(t) dt \leq k^2 \int_0^\infty u^2(t) dt$ . Thus, in these three cases the system is both finite-gain  $\mathcal{L}_\infty$  and finite-gain  $\mathcal{L}_2$  stable. In case (c), the system is clearly  $\mathcal{L}_\infty$  stable since the output is always bounded. However, it is not  $\mathcal{L}_2$  stable. For example, the  $\mathcal{L}_2$  input  $u(t) = e^{-t}$  produces the output  $y(t) \equiv 1$  which is not  $\mathcal{L}_2$ .

• 5.6 Let  $V(t, x(t)) = 0$ .

$$\begin{aligned} D_+W &= \limsup_{h \rightarrow 0^+} \frac{1}{h} [W(t+h, x(t+h)) - W(t, x(t))] \\ &= \limsup_{h \rightarrow 0^+} \frac{1}{h} \sqrt{V(t+h, x(t+h))} \end{aligned}$$

We have

$$V(t+h, x(t+h)) \leq \frac{c_4}{2} \|x(t+h)\|^2$$

## 《非线性系统（第三版）》习题解答

$$x(t+h) = h[f(t,0) + g(t,0)] + o(h) \Rightarrow \|x(t+h)\|^2 = h^2\|g(t,0)\|^2 + ho(h)$$

$$\frac{1}{h^2} V(t+h, x(t+h)) \leq \frac{c_4}{2} \|g(t,0)\|^2 + \frac{o(h)}{h} \leq \frac{c_4}{2} \delta^2(t) + \frac{o(h)}{h}$$

$$\limsup_{h \rightarrow 0^+} \frac{1}{h} \sqrt{V(t+h, x(t+h))} \leq \sqrt{\frac{c_4}{2}} \delta(t) \leq \sqrt{\frac{c_4}{2c_1}} \sqrt{\frac{c_4}{2}} \delta(t)$$

since  $\sqrt{c_4/2c_1} \geq 1$ . Thus

$$D_+ W \leq \frac{c_4}{2\sqrt{c_1}} \delta(t)$$

which agrees with the right hand side of (5.12) at  $W = 0$ .

• 5.7 Following the proof of Theorem 5.1, it can be shown that

$$\|x(t)\| \leq \gamma_1 \sup_{t \geq 0} \|u(t)\| + \beta_1, \quad \text{where } \gamma_1 = \frac{c_2 c_4 L}{c_1 c_3}, \quad \beta_1 = \sqrt{\frac{c_2}{c_1}} \|x_0\|$$

Consequently,

$$\|y(t)\| \leq (\eta_1 \gamma_1 + \eta_2) \sup_{t \geq 0} \|u(t)\| + \beta_1 + \eta_3$$

which shows that (5.11) is satisfied with  $p = \infty$  and

$$\gamma = \eta_2 + \frac{\eta_1 c_2 c_4 L}{c_1 c_3}, \quad \beta = \eta_1 \|x_0\| \sqrt{\frac{c_2}{c_1}} + \eta_3$$

• 5.8 Following the proof of Theorem 5.1, it can be shown that

$$\|x(t)\| \leq \gamma_1 \sup_{t \geq 0} \|u(t)\| + \beta_1, \quad \text{where } \gamma_1 = \frac{c_2 c_4 L}{c_1 c_3}, \quad \beta_1 = \sqrt{\frac{c_2}{c_1}} \|x_0\|$$

Using (5.20), we obtain

$$\begin{aligned} \|y(t)\| &\leq \alpha_1 \left( \gamma_1 \sup_{t \geq 0} \|u(t)\| + \beta_1 \right) + \alpha_2 \left( \sup_{t \geq 0} \|u(t)\| \right) + \eta \\ &\leq \alpha_1 \left( 2\gamma_1 \sup_{t \geq 0} \|u(t)\| \right) + \alpha_1 (2\beta_1) + \alpha_2 \left( \sup_{t \geq 0} \|u(t)\| \right) + \eta \end{aligned}$$

which shows that (5.22) is satisfied with

$$\gamma_0(r) = \alpha_1 (2\gamma_1 r) + \alpha_2(r), \quad \beta_0 = \alpha_1 (2\beta_1) + \eta$$

• 5.9 Consider the system

$$\dot{x} = A(t)x + B(t)u$$

$$y = C(t)x + D(t)u$$

Assume that all matrices are uniformly bounded; that is,

$$\|A(t)\| \leq c_1, \quad \|B(t)\| \leq c_2, \quad \|C(t)\| \leq c_3, \quad \|D(t)\| \leq c_4, \quad \forall t \geq t_0$$

and the origin of  $\dot{x} = A(t)x$  is exponentially stable so that the transition matrix  $\Phi(t, t_0)$  satisfies

$$\|\Phi(t, t_0)\| \leq ke^{-a(t-t_0)}, \quad \forall t \geq t_0$$

It can be easily shown that

$$\|y(t)\| \leq c_3 ke^{-a(t-t_0)} \|x_0\| + \int_{t_0}^t c_2 c_3 ke^{-a(t-\tau)} \|u(\tau)\| d\tau + c_4 \|u(t)\|$$

From this point on, proceed as in Corollary 5.2.

## 《非线性系统（第三版）》习题解答

- 5.10 (1) Let  $V(x) = \frac{1}{2}x^2$ .

$$\dot{V} = -(1+u)x^4 \leq -(1-r_u)x^4, \quad \forall |u| \leq r_u < 1$$

By Theorem 5.2, we conclude that the system is small-signal  $\mathcal{L}_\infty$  stable for sufficiently small  $|x(0)|$ . Taking  $u(t) \equiv -2$ , it can be seen that the system is not  $\mathcal{L}_\infty$  stable. The origin of the unforced system is not exponentially stable. However, the origin of the forced system is asymptotically stable for  $|u| < 1$ , which implies that  $|y(t)| \leq \beta(|x_0|, t)$ . Therefore, the system is small-signal finite-gain  $\mathcal{L}_\infty$  stable.

(2) We saw in Exercise 4.54 that the system is input-to-state stable. Using Theorem 5.3, we conclude that the system is  $\mathcal{L}_\infty$  stable. The origin of the unforced system is not exponentially stable. However, the origin of the forced system is asymptotically stable for  $|u| < 1$ , which implies that  $|y(t)| \leq \beta(|x_0|, t) + |u(t)|$ . Therefore, the system is small-signal finite-gain  $\mathcal{L}_\infty$  stable.

(3) Since  $|y| \leq \frac{1}{2}$ , the system is finite-gain  $\mathcal{L}_\infty$  stable.

(4) With  $V = \frac{1}{2}x^2$ , we have

$$\dot{V} = -x^2 - x^4 + x^3u \leq -x^2, \quad \forall |x| \geq |u|$$

By Theorem 4.19 we conclude that the system is input-to-state stable. Using  $|y| = |x \sin(u)| \leq |x|$ , we conclude by Theorem 5.3 that the system is  $\mathcal{L}_\infty$  stable.

• 5.11 (1) We saw in Exercise 4.55(1) that the system is input-to-state stable. By Theorem 5.3, it is  $\mathcal{L}_\infty$  stable. Take  $V = \frac{1}{2}(x_1^2 + x_2^2)$  and set  $u = 0$ . Then,  $\dot{V} = -2V$ , which shows that the origin is globally exponentially stable. All the assumptions of Theorem 5.1 are satisfied globally. Therefore, the system is finite-gain  $\mathcal{L}_\infty$  stable.

(2) We saw in Exercise 4.55(2) that the system is input-to-state stable. By Theorem 5.3, it is  $\mathcal{L}_\infty$  stable. By linearization, it can be seen that the origin of the unforced system is exponentially stable and all the assumptions of Theorem 5.1 are satisfied locally. Hence, the system is small-signal finite-gain  $\mathcal{L}_\infty$  stable for sufficiently small  $\|x(0)\|$ .

(3) Let  $V = \frac{1}{2}(x_1^2 + x_2^2)$ . When  $u = 0$ , we have

$$\dot{V} = 2V(2V - 1) > 0 \quad \text{when } V > 1/2$$

Thus, solutions starting in  $\|x\|_2 > 1$  grow unbounded. This shows that the system is not  $\mathcal{L}_\infty$  stable. By linearization, it can be seen that the origin of the unforced system is exponentially stable and all the assumptions of Theorem 5.1 are satisfied locally. Hence, the system is small-signal finite-gain  $\mathcal{L}_\infty$  stable for sufficiently small  $\|x(0)\|$ .

(4) We saw in Exercise 4.55(6) that the system is input-to-state stable. By Theorem 5.3, it is  $\mathcal{L}_\infty$  stable. By linearization, it can be seen that the origin of the unforced system is exponentially stable and all the assumptions of Theorem 5.1 are satisfied locally. Hence, the system is small-signal finite-gain  $\mathcal{L}_\infty$  stable for sufficiently small  $\|x(0)\|$ .

(5) With  $u = 0$ , the system has three equilibrium points at  $(0, 0)$ ,  $(1, 1)$  and  $(-1, -1)$ . By linearization, it can be seen that the equilibrium points at  $(1, 1)$  and  $(-1, -1)$  are saddles. By sketching the phase portrait, we can see that there are trajectories that diverge to infinity. Hence, the system is not  $\mathcal{L}_\infty$  stable. By linearization, it can be seen that the origin of the unforced system is exponentially stable and all the assumptions of Theorem 5.1 are satisfied locally. Hence, the system is small-signal finite-gain  $\mathcal{L}_\infty$  stable for sufficiently small  $\|x(0)\|$ .

(6) We saw in Exercise 4.55(3) that the system is input-to-state stable. By Theorem 5.3, it is  $\mathcal{L}_\infty$  stable. By linearization, it can be seen that the origin of the unforced system is not exponentially stable. Therefore, we cannot apply Theorem 5.1.

(7) We view the system as a cascade connection of the linear system

$$\dot{x}_1 = -x_1 - x_2, \quad \dot{x}_2 = x_1 - x_3 + u, \quad y_1 = x_1$$

and the delay element  $y(t) = y_1(t - T)$ . The linear system has a Hurwitz matrix. Hence, by Corollary 5.2, it is finite-gain  $\mathcal{L}_\infty$  stable. The time-delay element is finite-gain  $\mathcal{L}_\infty$  stable. Hence, the cascade connection is finite-gain  $\mathcal{L}_\infty$  stable.



## 《非线性系统（第三版）》习题解答

• 5.12 We start by investigating stability of the unforced system

$$\dot{x}_1 = x_2, \quad \dot{x}_2 = -(x_1 + x_2) - h(x_1 + x_2)$$

We use the variable gradient method to find a Lyapunov function.  $\dot{V} = g^T(x)f(x) = g_1(x)f_1(x) + g_2(x)f_2(x)$ . Since  $f_2(x) = -(x_1 + x_2) - h(x_1 + x_2)$ , let us take  $g_2 = x_1 + x_2$ . From the symmetry condition  $\partial g_1/\partial x_2 = \partial g_2/\partial x_1 = 1$ , we take  $g_1 = bx_1 + x_2$ . Then  $V(x) = \frac{1}{2}bx_1^2 + x_1x_2 + \frac{1}{2}x_2^2$ . The quadratic function  $V(x)$  is positive definite for  $b > 1$ .

$$\dot{V} = (bx_1 + x_2)x_2 - (x_1 + x_2)^2 - (x_1 + x_2)h(x_1 + x_2) = -x_1^2 + (b-2)x_1x_2 - (x_1 + x_2)h(x_1 + x_2)$$

Taking  $b = 2$  yields

$$\dot{V} = -x_1^2 - (x_1 + x_2)h(x_1 + x_2) \leq -x_1^2 - a(x_1 + x_2)^2 = -x^T Q x$$

where  $Q = \begin{bmatrix} 1+a & -a \\ -a & a \end{bmatrix}$ . The matrix  $Q$  is positive definite; hence, the equilibrium point at the origin is globally exponentially stable. Now consider the forced system. The Lyapunov function  $V$  satisfies inequalities (5.6)-(5.8) globally. It is easy to see that (5.9) and (5.10) are satisfied globally. It follows from Theorem 5.1 that the system is  $\mathcal{L}_p$  stable for each  $p \in [1, \infty]$ .

• 5.13 Since  $W(x)$  is positive definite and radially unbounded, it follows from Lemma 4.3 that there is a class  $\mathcal{K}_\infty$  function  $\alpha$  such that  $W(x) \geq \alpha(\|x\|)$  for all  $x \in R^n$ . Since  $|\psi(u)|$  is positive definite, it follows from Lemma 4.3 that there is a class  $\mathcal{K}$  function  $\rho_0$  such that  $|\psi(u)| \leq \rho_0(\|u\|)$  for all  $u \in R^m$ . Hence,

$$\frac{\partial V}{\partial x} f(x, u) \leq -\alpha(\|x\|) + \rho_0(\|u\|) \leq -\frac{1}{2}\alpha(\|x\|), \quad \forall \|x\| \geq \alpha^{-1}(2\rho_0(\|u\|))$$

We conclude from Theorem 4.19 that the system is input-to-state stable. Furthermore,  $\|h(x, u)\|$  is a positive definite function of  $\begin{bmatrix} x \\ u \end{bmatrix}$ . It follows from Lemma 4.3 that there is a class  $\mathcal{K}_\infty$  function  $\rho_1$  such that

$$\|h(x, u)\| \leq \rho_1\left(\left\|\begin{bmatrix} x \\ u \end{bmatrix}\right\|\right) \leq \rho_1(2\|x\|) + \rho_1(2\|u\|), \quad \forall (x, u)$$

Thus, (5.23) is satisfied globally with  $\eta = 0$ . We conclude from Theorem 5.3 that the system is  $\mathcal{L}_\infty$  stable.

• 5.14 From Example 5.2, we know that

$$\|y_r\|_{\mathcal{L}_2} \leq \|h\|_{\mathcal{L}_1} \|u_r\|_{\mathcal{L}_2}$$

This inequality implies that the  $\mathcal{L}_2$  gain is less than or equal to  $\|h\|_{\mathcal{L}_1} = \int_0^\infty |h(t)| dt$ . From Theorem 5.4, we know that the  $\mathcal{L}_2$  gain is  $\sup_{\omega \in R} |H(j\omega)|$ . Hence,

$$\sup_{\omega \in R} |H(j\omega)| \leq \int_0^\infty |h(t)| dt$$

• 5.15 (1)

$$f(x) = \begin{bmatrix} x_2 \\ -a \sin x_1 - kx_2 \end{bmatrix}, \quad G = \begin{bmatrix} 0 \\ 1 \end{bmatrix}, \quad h(x) = x_2$$

Let  $W(x) = a(1 - \cos x_1) + \frac{1}{2}x_2^2$ .  $W(x) \geq 0$  for all  $x \in R^2$ .

$$\frac{\partial W}{\partial x} f(x) = \begin{bmatrix} a \sin x_1 & x_2 \end{bmatrix} \begin{bmatrix} x_2 \\ -a \sin x_1 - kx_2 \end{bmatrix} = -kx_2^2 = -kh^2(x)$$

## 《非线性系统（第三版）》习题解答

$$\frac{\partial W}{\partial x} G = [ a \sin x_1 \quad x_2 ] \begin{bmatrix} 0 \\ 1 \end{bmatrix} = x_2 = h(x)$$

Thus,  $W(x)$  satisfies (5.32)–(5.33) globally. It follows from Example 5.9 that the system is finite-gain  $\mathcal{L}_2$  stable and its  $\mathcal{L}_2$  gain is less than or equal to  $1/k$ .

(2)

$$f(x) = \begin{bmatrix} -x_2 \\ x_1 - x_2 \operatorname{sat}(x_2^2 - x_3^2) \\ x_3 \operatorname{sat}(x_2^2 - x_3^2) \end{bmatrix}, \quad G = \begin{bmatrix} 0 \\ x_2 \\ -x_3 \end{bmatrix}, \quad h(x) = x_2^2 - x_3^2$$

Let  $W(x) = \frac{1}{2}x^T x$ .

$$\frac{\partial W}{\partial x} f(x) = [ x_1 \quad x_2 \quad x_3 ] \begin{bmatrix} -x_2 \\ x_1 - x_2 \operatorname{sat}(x_2^2 - x_3^2) \\ x_3 \operatorname{sat}(x_2^2 - x_3^2) \end{bmatrix} = -(x_2^2 - x_3^2) \operatorname{sat}(x_2^2 - x_3^2) = -h \operatorname{sat}(h)$$

$$\frac{\partial W}{\partial x} G = [ x_1 \quad x_2 \quad x_3 ] \begin{bmatrix} 0 \\ x_2 \\ -x_3 \end{bmatrix} = x_2^2 - x_3^2 = h(x)$$

Let  $D = \{x \in \mathbb{R}^2 \mid |h(x)| \leq 1\}$ .  $W(x)$  satisfies (5.32)–(5.33) in  $D$  with  $k = 1$ . Taking  $V(x) = W(x)$  and  $\gamma = 1$ , it can be verified that (5.28) is satisfied in  $D$ . Consider now the unforced system.

$$\begin{aligned} h(x(t)) \equiv 0 &\Rightarrow \dot{x}_3(t) \equiv 0 \Rightarrow x_3(t) \equiv \text{constant} \Rightarrow \dot{x}_2(t) \equiv 0 \\ &\Rightarrow x_1(t) \equiv 0 \Rightarrow \dot{x}_1(t) \equiv 0 \Rightarrow x_2(t) \equiv 0 \Rightarrow x_3(t) \equiv 0 \end{aligned}$$

Using of Lemma 5.2, we conclude that, for sufficiently small  $\|x_0\|$ , the system is small-signal finite-gain  $\mathcal{L}_2$  stable and its  $\mathcal{L}_2$  gain is less than or equal to 1.

(3) Let  $D = \{x \in \mathbb{R}^2 \mid |2x_1 + x_2| < 1\}$ . For  $x \in D$ , the system is given by

$$\dot{x} = Ax + Bu, \quad y = Cx$$

where

$$A = \begin{bmatrix} 0 & 1 \\ -1 & -1 \end{bmatrix}, \quad B = \begin{bmatrix} 0 \\ 1 \end{bmatrix}, \quad C = [ 1 \quad 0 ]$$

Since  $A$  is Hurwitz, there exist positive constants  $k_1$  and  $k_2$  such that for all  $\|x(0)\| < k_1$  and  $\sup_{t \geq 0} |u(t)| \leq k_2$ ,  $x(t) \in D$  for all  $t \geq 0$ . The system is linear time-invariant and its  $\mathcal{L}_2$  gain can be determined using Theorem 5.4. The transfer function is

$$H(s) = \frac{1}{s^2 + s + 1} = \frac{\omega_n^2}{s^2 + 2\zeta\omega_n s + \omega_n^2}, \quad \omega_n = 1, \quad \zeta = 0.5$$

$$\sup_{\omega \in \mathbb{R}} |H(j\omega)| = \frac{1}{2\zeta\sqrt{1-\zeta^2}} = \frac{2}{\sqrt{3}}$$

Thus, for sufficiently small  $\|x_0\|$ , the system is small-signal finite-gain  $\mathcal{L}_2$  stable and its  $\mathcal{L}_2$  gain is  $2/\sqrt{3}$ .

(4)

$$f(x) = \begin{bmatrix} x_2 \\ -(1+x_1^2)x_2 - x_1^3 \end{bmatrix}, \quad G = \begin{bmatrix} 0 \\ x_1 \end{bmatrix}, \quad h(x) = x_1 x_2$$

Let  $W(x) = \frac{1}{4}x_1^4 + \frac{1}{2}x_2^2$ .

$$\frac{\partial W}{\partial x} f(x) = [ x_1^3 \quad x_2 ] \begin{bmatrix} x_2 \\ -(1+x_1^2)x_2 - x_1^3 \end{bmatrix} = -(1+x_1^2)x_2^2 \leq -x_1^2 x_2^2 = -h^2(x)$$

## 《非线性系统（第三版）》习题解答

$$\frac{\partial W}{\partial x} G = \begin{bmatrix} x_1^3 & x_2 \end{bmatrix} \begin{bmatrix} 0 \\ x_1 \end{bmatrix} = x_1 x_2 = h(x)$$

Thus,  $W(x)$  satisfies (5.32)–(5.33) globally with  $k = 1$ . It follows from Example 5.9 that the system is finite-gain  $\mathcal{L}_2$  stable and its  $\mathcal{L}_2$  gain is less than or equal to 1.

• 5.16 (a) Let  $V(x) = \int_0^{x_1} \sigma(y) dy + \frac{1}{2}(x_1^2 + x_2^2)$ .

$$\begin{aligned} \dot{V} &= -x_1^2 - x_1\sigma(x_1) - x_2^2 + x_2 u \leq -x_1^2 - x_2^2 + x_2 u \\ &\leq -(1-\theta)\|x\|_2^2 - \theta\|x\|_2^2 + \|x\|_2|u| \leq -(1-\theta)\|x\|_2^2; \quad \forall \|x\|_2 \geq |u|/\theta \end{aligned}$$

where  $0 < \theta < 1$ . It follows from Theorem 4.19 that the system is input-to-state stable. Since  $|y| = |x_2| \leq \|x\|_2$ , we conclude from Theorem 5.3 that the the system is  $\mathcal{L}_\infty$  stable.

(b) Let  $V(x) = \alpha[\int_0^{x_1} \sigma(y) dy + \frac{1}{2}(x_1^2 + x_2^2)]$ .

$$\begin{aligned} \mathcal{H} &= \frac{\partial V}{\partial x} f + \frac{1}{2\gamma^2} \frac{\partial V}{\partial x} G G^T \left( \frac{\partial V}{\partial x} \right)^T + \frac{1}{2} h^T h \\ &= \alpha[-x_1^2 - x_1\sigma(x_1) - x_2^2] + \frac{\alpha^2}{2\gamma^2} x_2^2 + \frac{1}{2} x_2^2 \leq \left( -\alpha + \frac{\alpha^2}{2\gamma^2} + \frac{1}{2} \right) x_2^2 \end{aligned}$$

Choosing  $\alpha = \gamma = 1$  yields  $\mathcal{H} \leq 0$ . Hence, the system is finite-gain  $\mathcal{L}_2$  stable with  $\mathcal{L}_2$  gain less than or equal to one.

• 5.17

$$\begin{aligned} \frac{\partial V}{\partial x} f + \frac{\partial V}{\partial x} G u &= \frac{\partial V}{\partial x} f + \frac{\partial V}{\partial x} G u - \frac{1}{2}(L + W u)^T (L + W u) + \frac{1}{2}(L + W u)^T (L + W u) \\ &= -\frac{1}{2}(L + W u)^T (L + W u) + \frac{\partial V}{\partial x} f + \frac{\partial V}{\partial x} G u + \frac{1}{2} L^T L + L^T W u + \frac{1}{2} u^T W^T W u \\ &= -\frac{1}{2}(L + W u)^T (L + W u) + \left\{ \frac{\partial V}{\partial x} f + \frac{1}{2} L^T L + \frac{1}{2} h^T h \right\} \\ &\quad - \frac{1}{2} h^T h + \frac{\partial V}{\partial x} G u - h^T J u - \frac{\partial V}{\partial x} G u + \frac{1}{2} u^T (\gamma^2 I - J^T J) u \\ &= -\frac{1}{2}(L + W u)^T (L + W u) + \mathcal{H} - \frac{1}{2} h^T h - h^T J u + \frac{1}{2} \gamma^2 u^T u - \frac{1}{2} u^T J^T J u \\ &= -\frac{1}{2}(L + W u)^T (L + W u) + \mathcal{H} + \frac{1}{2} \gamma^2 u^T u - \frac{1}{2} y^T y \end{aligned}$$

$\mathcal{H} \leq 0$  implies

$$\frac{\partial V}{\partial x} f + \frac{\partial V}{\partial x} G u \leq \frac{1}{2} \gamma^2 u^T u - \frac{1}{2} y^T y$$

From this point on, proceed as in the proof of Theorem 5.5 (starting from (5.29)).

• 5.18 The closed-loop system is given by

$$\dot{x} = f - G G^T \left( \frac{\partial V}{\partial x} \right)^T + K w$$

The closed-loop map from  $w$  to  $\begin{bmatrix} y \\ u \end{bmatrix}$  is given by

$$\begin{aligned} \dot{x} &= f_c(x) + G_c(x) w \\ y_c &= h_c(x) \end{aligned}$$

## 《非线性系统（第三版）》习题解答

where

$$f_c = f - GG^T \left( \frac{\partial V}{\partial x} \right)^T, \quad G_c = K, \quad y_c = \begin{bmatrix} y \\ u \end{bmatrix}, \quad h_c = \begin{bmatrix} h \\ -G^T \left( \frac{\partial V}{\partial x} \right)^T \end{bmatrix}$$

For the closed-loop system, the left-hand side of (5.28) is given by

$$\begin{aligned} \mathcal{H}_c &= \frac{\partial V}{\partial x} f_c + \frac{1}{2\gamma^2} \left( \frac{\partial V}{\partial x} \right) G_c G_c^T \left( \frac{\partial V}{\partial x} \right)^T + \frac{1}{2} h_c^T h_c \\ &= \frac{\partial V}{\partial x} \left[ f - GG^T \left( \frac{\partial V}{\partial x} \right)^T \right] + \frac{1}{2\gamma^2} \left( \frac{\partial V}{\partial x} \right) K K^T \left( \frac{\partial V}{\partial x} \right)^T + \frac{1}{2} h^T h + \frac{1}{2} \left( \frac{\partial V}{\partial x} \right) G G^T \left( \frac{\partial V}{\partial x} \right)^T \\ &= \frac{\partial V}{\partial x} f + \frac{1}{2} \left( \frac{\partial V}{\partial x} \right) \left[ \frac{1}{\gamma^2} K K^T - G G^T \right] \left( \frac{\partial V}{\partial x} \right)^T + \frac{1}{2} h^T h \\ &\leq 0 \end{aligned}$$

From Theorem 5.5, we conclude that the closed-loop map from  $w$  to  $\begin{bmatrix} y \\ u \end{bmatrix}$  is finite-gain  $\mathcal{L}_2$  stable with  $\mathcal{L}_2$  gain less than or equal to  $\gamma$ .

• 5.19 (a) The existence of  $\delta$  follows from the fact that

$$\lim_{\delta \rightarrow 0} \frac{1 - \epsilon/2 - \sqrt{\delta}}{\sqrt{1 - \delta}} = 1 - \frac{\epsilon}{2} > 1 - \epsilon$$

Thus, by choosing  $\delta$  small enough, we can make  $(1 - \epsilon/2 - \sqrt{\delta})/\sqrt{1 - \delta} \geq 1 - \epsilon$ .

(b) By definition of the  $\mathcal{L}_{2R}$  gain, we can find  $u \in \mathcal{L}_{2R}$  such that  $\|u\|_{\mathcal{L}_{2R}} = 1$  and  $\|y\|_{\mathcal{L}_{2R}} \geq \gamma_{2R}(1 - \epsilon/2)$ . If there was no such  $u$ , we would have  $\|y\|_{\mathcal{L}_{2R}} \leq \gamma_{2R}(1 - \epsilon/2)$  for all  $\|u\|_{\mathcal{L}_{2R}} = 1$ , which contradicts the claim that  $\gamma_{2R}$  is the  $\mathcal{L}_{2R}$  gain. By choosing  $\delta$  of part (a) less than one, there exists time  $t_1$  such that  $\int_{-\infty}^{t_1} u^T(t)u(t) dt = \delta$ .

(c) We have

$$\begin{aligned} \int_{-\infty}^{\infty} u_2^T(t)u_2(t) dt &= \int_{-\infty}^{t_1} u^T(t)u(t) dt = \delta \Rightarrow \|u_2\|_{\mathcal{L}_{2R}} = \sqrt{\delta} \\ \int_{-\infty}^{\infty} u_1^T(t)u_1(t) dt &= \int_{t_1}^{\infty} u^T(t)u(t) dt = 1 - \delta \Rightarrow \|u_1\|_{\mathcal{L}_{2R}} = \sqrt{1 - \delta} \end{aligned}$$

Consequently,

$$\|y_2\|_{\mathcal{L}_{2R}} \leq \gamma_{2R}\sqrt{\delta}$$

and

$$\|y_1\|_{\mathcal{L}_{2R}} \geq \|y\|_{\mathcal{L}_{2R}} - \|y_2\|_{\mathcal{L}_{2R}} \geq \gamma_{2R} \left( 1 - \frac{\epsilon}{2} \right) - \sqrt{\delta}\gamma_{2R}$$

Therefore,

$$\frac{\|y_1\|_{\mathcal{L}_{2R}}}{\|u_1\|_{\mathcal{L}_{2R}}} \geq \frac{1 - \epsilon/2 - \sqrt{\delta}}{\sqrt{1 - \delta}} \gamma_{2R} \geq (1 - \epsilon)\gamma_{2R}$$

(d) Let  $u(t) = u_1(t + t_1)$  and  $y(t) = y_1(t + t_1)$

$$\int_0^{\infty} u^T(t)u(t) dt = \int_0^{\infty} u_1^T(t + t_1)u_1(t + t_1) dt = \int_{t_1}^{\infty} u_1^T(\tau)u_1(\tau) d\tau$$

Which implies that  $\|u\|_{\mathcal{L}_2} = \|u_1\|_{\mathcal{L}_{2R}}$ . Similarly,  $\|y\|_{\mathcal{L}_2} = \|y_1\|_{\mathcal{L}_{2R}}$ . The fact that  $y(t)$  is the output corresponding to  $u(t)$  follows from linearity. Finally,  $\|y\|_{\mathcal{L}_2} \geq (1 - \epsilon)\gamma_{2R}\|u\|_{\mathcal{L}_2}$  follows from part (c).

## 《非线性系统（第三版）》习题解答

- 5.20 The closed-loop transfer functions are given by

$$\begin{bmatrix} Y_1 \\ Y_2 \end{bmatrix} = \begin{bmatrix} \frac{s-1}{s+2} & \frac{-1}{s+2} \\ \frac{1}{s+2} & \frac{s+1}{(s-1)(s+2)} \end{bmatrix} \begin{bmatrix} U_1 \\ U_2 \end{bmatrix}, \quad \begin{bmatrix} E_1 \\ E_2 \end{bmatrix} = \begin{bmatrix} \frac{s+1}{s+2} & \frac{-(s+1)}{(s-1)(s+2)} \\ \frac{s-1}{s+2} & \frac{s+1}{s+2} \end{bmatrix} \begin{bmatrix} U_1 \\ U_2 \end{bmatrix}$$

The closed-loop transfer function from  $(u_1, u_2)$  to  $(y_1, y_2)$  (or  $(e_1, e_2)$ ) has four components. Due to pole-zero cancellation of the unstable pole  $s = 1$ , three of these components do not contain the unstable pole; thus, each component by itself is input-output stable. If we restrict our attention to any one of these components, we miss the unstable hidden mode. By studying all four components we will be sure that unstable hidden modes must appear in at least one component.

- 5.21

$$y_{1\tau} = (H_1 e_1)_\tau, \quad y_{2\tau} = (H_2 e_2)_\tau$$

$$\begin{aligned} \|y_{1\tau}\|_{\mathcal{L}} &\leq \gamma_1 \|e_{1\tau}\|_{\mathcal{L}} + \beta_1 \\ &\leq \gamma_1 \left[ \frac{1}{1 - \gamma_1 \gamma_2} (\|u_{1\tau}\|_{\mathcal{L}} + \gamma_2 \|u_{2\tau}\|_{\mathcal{L}} + \beta_2 + \gamma_2 \beta_1) \right] + \beta_1 \\ &= \frac{\gamma_1}{1 - \gamma_1 \gamma_2} \|u_{1\tau}\|_{\mathcal{L}} + \frac{\gamma_1 \gamma_2}{1 - \gamma_1 \gamma_2} \|u_{2\tau}\|_{\mathcal{L}} + \frac{\gamma_1 (\beta_2 + \gamma_2 \beta_1)}{1 - \gamma_1 \gamma_2} + \beta_1 \\ &= \frac{\gamma_1}{1 - \gamma_1 \gamma_2} \|u_{1\tau}\|_{\mathcal{L}} + \frac{\gamma_1 \gamma_2}{1 - \gamma_1 \gamma_2} \|u_{2\tau}\|_{\mathcal{L}} + \frac{\gamma_1 \beta_2 + \beta_1}{1 - \gamma_1 \gamma_2} \end{aligned}$$

The expression for  $\|y_{2\tau}\|_{\mathcal{L}}$  can be derived in the same way.

- 5.22 (a) Let the underlying space be  $\mathcal{L}_\infty$ . We have  $d_2, \dot{d}_2 \in \mathcal{L}_\infty$ . From the analysis of Example 5.14, we have  $e_1, e_2, x \in \mathcal{L}_\infty$ , provided  $\epsilon < 1/\gamma_1 \gamma_f$ . From the equation

$$\epsilon \dot{\eta} = A\eta + \epsilon A^{-1} B e_2$$

we see that  $\eta \in \mathcal{L}_\infty$ . Thus, for sufficiently small  $\epsilon$ , the state of the closed-loop system is uniformly bounded.

- (b) From (5.44), we see that one of the terms on the right-hand side is  $\epsilon \gamma_f \|d_2\|_{\mathcal{L}_\infty}$ . For  $d_2(t) = a \sin \omega t$ , this term is given by

$$\epsilon \gamma_f \|d_2\|_{\mathcal{L}_\infty} = \epsilon \omega a \gamma_f$$

When the product  $\epsilon \omega$  is small, the term is negligible. However, as we increase  $\omega$ , the product  $\epsilon \omega$  will no longer be small. At frequencies of the order  $O(1/\epsilon)$ , the product  $\epsilon \omega$  will be of order  $O(1)$ . While the system remains  $\mathcal{L}_\infty$  stable, the bound on  $x$ , given by (5.44), will not be close to the bound  $\gamma \|d\|_\infty + \beta + \gamma \beta_2$ , as concluded in the example. The conclusion of the example is valid only for frequencies of the order  $O(1)$  (or frequencies for which  $\epsilon \omega$  is small).

- 5.23 (a) Using

$$\begin{aligned} e_1 &= u_1 - y_2 = u - \frac{1}{2} x_3^3 \\ e_2 &= u_2 + y_1 = x_2 \end{aligned}$$

we obtain

$$\begin{aligned} \dot{x}_1 &= -x_1 + x_2 \\ \dot{x}_2 &= -x_1^3 - x_2 - \frac{1}{2} x_3^3 + u \\ \dot{x}_3 &= x_2 - x_3^3 \\ y &= x_2 \end{aligned}$$

## 《非线性系统（第三版）》习题解答

(b) We search for functions  $V_1$  and  $V_2$  that satisfy the Hamilton–Jacobi inequality for the systems  $H_1$  and  $H_2$ , respectively. For  $H_1$ , let  $V_1 = \alpha_1(\frac{1}{4}x_1^4 + \frac{1}{2}x_2^2)$ ,  $\alpha_1 > 0$ .

$$\mathcal{H} = -\alpha_1(x_1^4 + x_2^2) + \frac{\alpha_1^2}{2\gamma_1^2}x_2^2 + \frac{1}{2}x_2^2 \leq \left(-\alpha_1 + \frac{\alpha_1^2}{2\gamma_1^2} + \frac{1}{2}\right)x_2^2$$

Choosing  $\alpha_1$  to minimize  $\gamma_1$ , we end up with  $\alpha_1 = \gamma_1 = 1$ . For  $H_2$ , let  $V_2 = (\alpha_2/4)x_3^4$ ,  $\alpha_2 > 0$ .

$$\mathcal{H} = \left(-\alpha_2 + \frac{\alpha_2^2}{2\gamma_2^2} + \frac{1}{8}\right)x_3^6$$

Choosing  $\alpha_2$  to minimize  $\gamma_2$ , we end up with  $\alpha_2 = \gamma_2 = \frac{1}{4}$ . Since  $\gamma_1\gamma_2 = \frac{1}{4} < 1$ , we conclude by the small-gain theorem that the closed-loop system is finite-gain  $\mathcal{L}_2$  stable. To find an upper bound on the  $\mathcal{L}_2$  gain, we search for a function  $V$  that satisfies the Hamilton–Jacobi identity. We consider

$$V(x) = V_1 + V_2 = \alpha_1\left(\frac{1}{4}x_1^4 + \frac{1}{2}x_2^2\right) + \frac{\alpha_2}{4}x_3^4$$

and we allow ourselves the freedom to change the choice of the positive constants  $\alpha_1$  and  $\alpha_2$ .

$$\frac{\partial V}{\partial x}f = -\alpha_1x_1^4 - \alpha_1x_2^2 - \frac{\alpha_1}{2}x_2x_3^3 + \alpha_2x_2x_3^3 - \alpha_2x_3^6$$

Choose  $\alpha_2 = \alpha_1/2$  to cancel the cross product term.

$$\frac{\partial V}{\partial x}G = \alpha_1x_2$$

$$\mathcal{H} = -\alpha_1x_1^4 - \alpha_1x_2^2 - \frac{\alpha_1}{2}x_3^6 + \frac{\alpha_1^2}{2\gamma^2} + \frac{1}{2}x_2^2 \leq \left(-\alpha_1 + \frac{\alpha_1^2}{2\gamma^2}x_2^2 + \frac{1}{2}\right)x_2^2$$

Choosing  $\alpha_1$  to minimize  $\gamma$ , we end up with  $\alpha_1 = \gamma = 1$ . Thus, the  $\mathcal{L}_2$  gain is less than or equal to one. Note that a more conservative upper bound can be obtained by applying (5.40). According to (5.40), an upper bound on the  $\mathcal{L}_2$  gain from  $u = u_1$  to  $y = y_1$  is given by

$$\frac{\gamma_1}{1 - \gamma_1\gamma_2} = \frac{1}{1 - \frac{1}{4}} = \frac{4}{3}$$

## 《非线性系统（第三版）》习题解答

### Chapter 6

- 6.1 Define  $\hat{u}$ ,  $\hat{u}$ , and  $\hat{y}$  as shown in the next figure. Then,

$$\hat{y} = h(t, u) - K_1 u, \quad \hat{u} = Ku, \quad \hat{u} = \hat{u} + \hat{y}$$

From

$$[h(t, u) - K_1 u]^T [h(t, u) - K_2 u] \leq 0$$

we have

$$\hat{y}^T (\hat{y} - Ku) \leq 0 \Rightarrow \hat{y}^T (\hat{y} - \hat{u}) \leq 0 \Rightarrow \hat{y}^T (-\hat{u}) \leq 0 \Leftrightarrow \hat{y}^T \hat{u} \geq 0$$

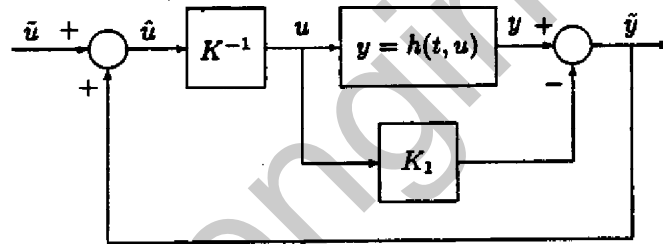

Figure 6.1: Exercise 6.1

- 6.2

$$\dot{V} = ah(x)\dot{x} = h(x) \left[ -x + \frac{1}{k}h(x) + u \right] = \frac{1}{k}h(x)[h(x) - kx] + h(x)u \leq yu$$

- 6.3 Take  $V(x) = \frac{\delta}{2}[ka^2x_1^2 + 2kax_1x_2 + x_2^2] + \delta \int_0^{x_1} h(y) dy$ , where  $\delta > 0$  and  $0 < k < 1$ .  $V(x)$  is positive definite and radially unbounded.

$$\begin{aligned} \dot{V} &= \delta[ka^2\dot{x}_1 + kax_2 + h(x_1)]x_2 + \delta(kax_1 + x_2)[-h(x_1) - ax_2 + u] \\ &= -\delta kax_1h(x_1) + \delta(ka - a)x_2^2 + \delta(kax_1 + x_2)u \end{aligned}$$

$$yu - \dot{V} = (\alpha x_1 + x_2)u + \delta kax_1h(x_1) - \delta(ka - a)x_2^2 - \delta(kax_1 + x_2)u$$

Take  $\delta = 1$  and  $k = \alpha/a < 1$ .

$$yu - \dot{V} = \alpha x_1 h(x_1) + \delta(a - \alpha)x_2^2$$

The right-hand side is a positive definite function. Hence, the system is strictly passive.

## 《非线性系统（第三版）》习题解答

- 6.4 Since  $0 < p_{12} < ak/2$ ,  $P$  is positive definite.

$$\begin{aligned}
 \dot{V} &= kh(x_1)\dot{x}_1 + 2x^T P \dot{x} \\
 &= kh(x_1)x_2 + (2ap_{12}x_1 + 2p_{12}x_2)x_2 + (2p_{12}x_1 + kx_2)[-h(x_1) - ax_2 + u] \\
 &= 2p_{12}x_2^2 - 2p_{12}x_1h(x_1) + 2p_{12}x_1u - kax_2^2 + kx_2u
 \end{aligned}$$

Hence,

$$\begin{aligned}
 yu &= \dot{V} + u^2 - 2p_{12}x_2^2 + 2p_{12}x_1h(x_1) - 2p_{12}x_1u + kax_2^2 \\
 &= \dot{V} + (u - p_{12}x_1)^2 - p_{12}^2x_1^2 + 2p_{12}x_1h(x_1) + (ka - 2p_{12})x_2^2 \\
 &\geq \dot{V} - p_{12}^2x_1^2 + 2\alpha_1p_{12}x_1^2 + (ka - 2p_{12})x_2^2 = \dot{V} + \psi(x)
 \end{aligned}$$

Since  $p_{12} < \min\{2\alpha_1, ak/2\}$ ,  $\psi(x)$  is positive definite. Hence, the system is strictly passive.

- 6.5 We have  $X(s) = (Ms + K)^{-1}U(s)$  or  $(Ms + K)X(s) = U(s)$ . Thus, the state model for the dynamical system is

$$M\dot{x} = -Kx + u$$

Let  $V(x) = \int_0^x h^T(\sigma)M d\sigma \geq 0$ .

$$\dot{V} = h^T(x)M\dot{x} = h^T(x)(-Kx + u) \leq -h^T(x)h(x) + h^T(x)u = -y^T y + y^T u$$

Hence, the system is output strictly passive.

- 6.6 We have  $u_1 = u_2 = u$  and  $y = y_1 + y_2$ . Let

$$\begin{aligned}
 u^T y_1 &\geq \frac{\partial V_1}{\partial x_1} f_1(x_1, u) + u^T \varphi_1(u) + y_1^T \rho_1(y_1) + \psi_1(x_1) \\
 u^T y_2 &\geq \frac{\partial V_2}{\partial x_2} f_2(x_2, u) + u^T \varphi_2(u) + y_2^T \rho_2(y_2) + \psi_2(x_2)
 \end{aligned}$$

where  $V_1 = V_1(x_1)$  and  $V_2 = V_2(x_2)$ . Then,

$$u^T y = u^T (y_1 + y_2) \geq \frac{\partial V}{\partial x} f(x, u) + u^T \varphi(u) + y_1^T \rho_1(y_1) + y_2^T \rho_2(y_2) + \psi(x)$$

where  $V(x) = V_1(x_1) + V_2(x_2)$ ,  $\varphi(u) = \varphi_1(u) + \varphi_2(u)$ ,  $\psi(x) = \psi_1(x_1) + \psi_2(x_2)$ , and  $f(x, u) = \begin{bmatrix} f_1(x_1, u) \\ f_2(x_2, u) \end{bmatrix}$ .

The proof follows from this inequality for the cases of passivity, strict passivity, and input strict passivity. For output strict passivity, we require  $y_i^T \rho_i(y_i) \geq \delta_i y_i^T y_i$ , for all  $y_i$ , for some  $\delta_i > 0$ . Then

$$y_1^T \rho_1(y_1) + y_2^T \rho_2(y_2) \geq \frac{1}{2} \min\{\delta_1, \delta_2\} y^T y$$

where we used the fact that

$$(y_1 + y_2)^T (y_1 + y_2) \leq 2(y_1^T y_1 + y_2^T y_2)$$

- 6.7  $G(s)$  is Hurwitz if and only if  $a_1$  and  $a_2$  are positive.

$$\operatorname{Re}[G(j\omega)] = \operatorname{Re} \left[ \frac{b_1 + jb_0\omega}{a_2 - \omega^2 + ja_1\omega} \right] = \frac{b_1 a_2 + (b_0 a_1 - b_1)\omega^2}{(a_2 - \omega^2)^2 + a_1^2 \omega^2}$$

$\operatorname{Re}[G(j\omega)] > 0$  for all  $\omega \in \mathbb{R}$  if and only if  $b_1 > 0$  and  $b_0 a_1 \geq b_1$ .

$$\lim_{\omega \rightarrow \infty} \omega^2 \operatorname{Re}[G(j\omega)] = b_0 a_1 - b_1$$

Thus,  $G(s)$  is strictly positive real if and only if all coefficients are positive and  $b_1 < b_0 a_1$ .



## 《非线性系统（第三版）》习题解答

• 6.8 For any strictly positive real transfer function,  $D + D^T \geq 0$ . Since,  $D + D^T$  is nonsingular, we have  $D + D^T > 0$ . Hence,  $W$  is a square nonsingular matrix. Thus,

$$L^T L = L^T W (D + D^T)^{-1} W^T L$$

Substituting for  $W^T L$  from (6.15) we obtain

$$L^T L = (C^T - PB)(D + D^T)^{-1}(C - B^T P)$$

Substituting this expression in (6.14) yields

$$P[(\varepsilon/2)I + A] + [(\varepsilon/2)I + A]^T P + (C^T - PB)(D + D^T)^{-1}(C - B^T P) = 0$$

Factoring out the quadratic term, we obtain the given Riccati equation.

• 6.9 Since the system is input strictly passive with  $\varphi(u) = \varepsilon u$ , we have

$$u^T y \geq \frac{\partial V}{\partial x} f(x, u) + \varepsilon u^T u, \quad \varepsilon > 0$$

Since the system is finite-gain  $\mathcal{L}_2$  stable, we have

$$\int_{\tau_1}^{\tau_2} y^T(t)y(t) dt \leq \gamma_1 \int_{\tau_1}^{\tau_2} u^T(t)u(t) dt + \beta_1, \quad \gamma_1 > 0, \beta_1 \geq 0$$

To arrive at the desired inequality, we need to assume that  $\beta_1 = 0$ . From the first inequality, we have

$$\begin{aligned} V(x(\tau_2)) - V(x(\tau_1)) &\leq \int_{\tau_1}^{\tau_2} [u^T(t)y(t) - \varepsilon u^T(t)u(t)] dt \\ &= \int_{\tau_1}^{\tau_2} u^T(t)y(t) dt - \frac{\varepsilon}{2} \int_{\tau_1}^{\tau_2} u^T(t)u(t) dt - \frac{\varepsilon}{2} \int_{\tau_1}^{\tau_2} u^T(t)u(t) dt \\ &\leq \int_{\tau_1}^{\tau_2} u^T(t)y(t) dt - \frac{\varepsilon}{2} \int_{\tau_1}^{\tau_2} u^T(t)u(t) dt - \frac{\varepsilon}{2\gamma_1} \int_{\tau_1}^{\tau_2} y^T(t)y(t) dt \end{aligned}$$

Since this inequality is valid for all  $\tau_2 \geq \tau_1 \geq 0$ , we have

$$\frac{\partial V}{\partial x} f(x, u) \leq u^T y - \frac{\varepsilon}{2} u^T u - \frac{\varepsilon}{2\gamma_1} y^T y \Rightarrow u^T y \geq \frac{\partial V}{\partial x} f(x, u) + \frac{\varepsilon}{2} u^T u + \frac{\varepsilon}{2\gamma_1} y^T y$$

• 6.10 (a) The equations of motion are

$$M(q)\ddot{q} + C(q, \dot{q})\dot{q} + D\dot{q} + g(q) = u, \quad y = \dot{q}$$

The derivative of  $V = \frac{1}{2}\dot{q}^T M(q)\dot{q} + P(q)$  is given by

$$\begin{aligned} \dot{V} &= \dot{q}^T M(q)\dot{q} + \frac{1}{2}\dot{q}^T \dot{M}\dot{q} + \frac{\partial P}{\partial q} \dot{q} \\ &= \dot{q}^T [u - C(q, \dot{q})\dot{q} - D\dot{q} - g(q)] + \frac{1}{2}\dot{q}^T \dot{M}\dot{q} + \dot{q}^T g(q) = y^T u - y^T D y \leq y^T u \end{aligned}$$

where we have used the property that  $\dot{M} - 2C$  is a skew-symmetric matrix. The inequality  $\dot{V} \leq y^T u$  shows that the system is passive.

(b) In this case

$$\dot{V} \leq y^T (-K_d y + v)$$

## 《非线性系统（第三版）》习题解答

which shows that the map from  $v$  to  $y$  is output strictly passive.

(c) With  $v = 0$ , we have

$$\begin{aligned}\dot{V} &\leq -y^T K_d y = -\dot{q}^T K_d \dot{q} \leq 0 \\ \dot{V} = 0 &\Rightarrow \dot{q}(t) \equiv 0 \Rightarrow \ddot{q}(t) \equiv 0 \Rightarrow g(q(t)) \equiv 0 \Rightarrow q(t) \equiv 0\end{aligned}$$

Hence, the origin is asymptotically stable. It will be globally asymptotically stable if  $q = 0$  is the unique root of  $g(q) = 0$  and  $P(q)$  is radially unbounded.

• 6.11 (a) Let  $V = \frac{1}{2}J_1\omega_1^2 + \frac{1}{2}J_2\omega_2^2 + \frac{1}{2}J_3\omega_3^2$

$$\begin{aligned}\dot{V} &= J_1\omega_1\dot{\omega}_1 + J_2\omega_2\dot{\omega}_2 + J_3\omega_3\dot{\omega}_3 \\ &= (J_2 - J_3)\omega_1\omega_2\omega_3 + \omega_1u_1 + (J_3 - J_1)\omega_1\omega_2\omega_3 + \omega_2u_2 + (J_1 - J_2)\omega_1\omega_2\omega_3 + \omega_3u_3 = \omega^T u\end{aligned}$$

which shows that the system is lossless.

(b) With  $u = -K\omega + v$ , we have

$$\dot{V} = -\omega^T K\omega + v^T \omega \Rightarrow v^T \omega \geq \dot{V} + \lambda_{\min}(K)\|\omega\|_2^2$$

Hence, the map from  $v$  to  $\omega$  is finite gain  $\mathcal{L}_2$  stable with  $\mathcal{L}_2$  gain less than or equal to  $1/\lambda_{\min}(K)$ .

(c) With  $u = -K\omega$ , we have  $\dot{V} = -\omega^T K\omega$ .  $V$  is positive definite and radially unbounded and  $\dot{V}$  is negative definite for all  $\omega$ . Hence, the origin is globally asymptotically stable.

• 6.12

$$\begin{aligned}e_1 &= u_1 - y_2 = u_1 - h_2(x_2) - J_2(x_2)e_2 \\ e_2 &= u_2 + y_1 = u_2 + h_1(x_1) + J_1(x_1)e_1\end{aligned}$$

Substitute  $e_2$  from the second equation into the first one.

$$\begin{aligned}e_1 &= u_1 - h_2(x_2) - J_2(x_2)[u_2 + h_1(x_1) + J_1(x_1)e_1] \\ [I + J_2(x_2)J_1(x_1)]e_1 &= u_1 - h_2(x_2) - J_2(x_2)u_2 - J_2(x_2)h_1(x_1) \\ e_1 &= [I + J_2(x_2)J_1(x_1)]^{-1}[u_1 - h_2(x_2) - J_2(x_2)u_2 - J_2(x_2)h_1(x_1)] \\ e_2 &= u_2 + h_1(x_1) + J_1(x_1)[I + J_2(x_2)J_1(x_1)]^{-1}[u_1 - h_2(x_2) - J_2(x_2)u_2 - J_2(x_2)h_1(x_1)]\end{aligned}$$

Similarly, Substituting  $e_1$  from the first equation into the second one, we obtain

$$e_2 = [I + J_1(x_1)J_2(x_2)]^{-1}[u_2 + h_1(x_1) + J_1(x_1)u_1 - J_1(x_1)h_2(x_2)]$$

Substitute the expressions for  $e_1$  and  $e_2$  into the equations

$$\dot{x}_1 = f_1(x_1) + G_1(x_1)e_1, \quad \dot{x}_2 = f_2(x_2) + G_2(x_2)e_2$$

• 6.13 Let us start with (6.26)–(6.27).

$$e_1 = u_1 - h_2(x_2, e_2), \quad e_2 = u_2 + h_1(x_1)$$

substitute  $e_2$  from the second equation into the first one.

$$e_1 = u_1 - h_2(x_2, u_2 + h_1(x_1))$$

The pair  $(e_1, e_2)$  is uniquely determined. Consider now (6.30)–(6.31).

$$e_1 = u_1 - h_2(t, e_2), \quad e_2 = u_2 + h_1(x_1)$$

substitute  $e_2$  from the second equation into the first one.

$$e_1 = u_1 - h_2(t, u_2 + h_1(x_1))$$

The pair  $(e_1, e_2)$  is uniquely determined.

## 《非线性系统（第三版）》习题解答

- 6.14 (a) Take  $V_1 = (1/2)(x_1^2 + x_2^2)$  and  $V_2 = \int_0^{x_3} h_2(s) ds$ .

$$\dot{V}_1 = -x_2 h_1(x_2) + x_2 e_1 \Rightarrow y_1 e_1 = \dot{V}_1 + y_1 h_1(y_1)$$

Since  $h_1 \in (0, \infty]$ ,  $H_1$  is output strictly passive.

$$\dot{V}_2 = -x_3 h_2(x_3) + e_2 h_2(x_3) \Rightarrow y_2 e_2 = \dot{V}_2 + x_3 h_2(x_3)$$

Since  $h_2 \in (0, \infty]$ ,  $H_2$  is strictly passive. Thus, the feedback connection is passive.

(b) With  $e_1 = 0$ , we have

$$y_1(t) \equiv 0 \Rightarrow x_2(t) \equiv 0 \Rightarrow \dot{x}_2(t) \equiv 0 \Rightarrow x_1(t) \equiv 0$$

Hence,  $H_1$  is zero-state observable and the origin of the feedback connection is asymptotically stable. It is globally asymptotically stable if  $V_1$  and  $V_2$  are radially unbounded.  $V_1$  is radially unbounded because it is a quadratic form and  $V_2$  is radially unbounded because

$$\int_0^{x_3} h_2(s) ds \geq \int_0^{x_3} \frac{s}{1+s^2} ds = \frac{1}{2} \ln(1+x_3^2) \rightarrow \infty \text{ as } |x_3| \rightarrow \infty$$

Thus, the origin is globally asymptotically stable.

- 6.15 (a) Let  $V_1 = \frac{1}{4}x_1^4 + \frac{1}{2}x_2^2$ .

$$\dot{V}_1 = -x_1^4 - x_2^2 + y_1 e_1$$

Hence,  $H_1$  is strictly passive. Let  $V_2 = \frac{1}{4}x_3^4$ .

$$\dot{V}_2 = -x_3^4 + y_2 e_2$$

Hence,  $H_2$  is strictly passive. It follows from Theorem 6.1 that the feedback connection is passive.

(b) Since both systems are strictly passive with radially unbounded storage functions, it follows from Theorem 6.3 that the origin is globally asymptotically stable.

- 6.16 To study asymptotic stability, take  $u_1 = 0$  and  $u_2 = 0$ . Then,  $e_1 = -y_2$ ,  $e_2 = y_1$ . Suppose  $H_2$  is input strictly passive.

$$\dot{V}_1 \leq e_1^T y_1 = -y_2^T y_1, \quad V_2 \leq e_2^T y_2 - e_2^T \varphi_2(e_2) = y_1^T y_2 - e_2^T \varphi_2(e_2), \quad e_2^T \varphi_2(e_2) > 0 \quad \forall e_2 \neq 0$$

Take  $V = V_1 + V_2$ .

$$\dot{V} \leq -e_2^T \varphi_2(e_2) \leq 0 \text{ and } \dot{V} = 0 \Rightarrow e_2 = 0 \Rightarrow y_1 = 0$$

By zero-state observability of  $H_1(-H_2)$ ,

$$y_1(t) \equiv 0 \Rightarrow x(t) \equiv 0$$

Hence, by LaSalle's invariance principle, the origin is asymptotically stable. Similarly, suppose  $H_1$  is output strictly passive.

$$\dot{V}_1 \leq e_1^T y_1 - y_1^T \rho_1(y_1) = -y_2^T y_1 - y_1^T \rho_1(y_1), \quad V_2 \leq e_2^T y_2 = y_1^T y_2, \quad y_1^T \rho_1(y_1) > 0 \quad \forall y_1 \neq 0$$

Take  $V = V_1 + V_2$ .

$$\dot{V} \leq -y_1^T \rho_1(y_1) \leq 0 \text{ and } \dot{V} = 0 \Rightarrow y_1 = 0$$

By zero-state observability of  $H_1(-H_2)$ ,

$$y_1(t) \equiv 0 \Rightarrow x(t) \equiv 0$$

## 《非线性系统（第三版）》习题解答

• 6.17 To study asymptotic stability, take  $u_2 = 0$  and  $u_1 = 0$ . Then,  $e_2 = y_1$ ,  $e_1 = -y_2$ . Suppose  $H_1$  is input strictly passive.

$$\dot{V}_2 \leq e_2^T y_2 = y_1^T y_2, \quad \dot{V}_1 \leq e_1^T y_1 - e_1^T \varphi_1(e_1) = -y_2^T y_1 - e_1^T \varphi_1(e_1), \quad e_1^T \varphi_1(e_1) > 0 \quad \forall e_1 \neq 0$$

Take  $V = V_2 + V_1$ .

$$\dot{V} \leq -e_1^T \varphi_1(e_1) \leq 0 \quad \text{and} \quad \dot{V} = 0 \Rightarrow e_1 = 0 \Rightarrow y_2 = 0$$

By zero-state observability of  $H_2H_1$ ,

$$y_2(t) \equiv 0 \Rightarrow x(t) \equiv 0$$

Hence, by LaSalle's invariance principle, the origin is asymptotically stable. Similarly, suppose  $H_2$  is output strictly passive.

$$\dot{V}_2 \leq e_2^T y_2 - y_2^T \rho_2(y_2) = y_1^T y_2 - y_2^T \rho_2(y_2), \quad \dot{V}_1 \leq e_1^T y_1 = -y_2^T y_1, \quad y_2^T \rho_2(y_2) > 0 \quad \forall y_2 \neq 0$$

Take  $V = V_2 + V_1$ .

$$\dot{V} \leq -y_2^T \rho_2(y_2) \leq 0 \quad \text{and} \quad \dot{V} = 0 \Rightarrow y_2 = 0$$

By zero-state observability of  $H_2H_1$ ,

$$y_2(t) \equiv 0 \Rightarrow x(t) \equiv 0$$

• 6.18 To study asymptotic stability, take  $u_2 = 0$  and  $u_1 = 0$ . Then,  $e_2 = y_1$ ,  $e_1 = -y_2$ .

$$\dot{V}_1 \leq y_1^T Q_1 y_1 + 2y_1^T S_1 e_1 + e_1^T R_1 e_1, \quad \dot{V}_2 \leq y_2^T Q_2 y_2 + 2y_2^T S_2 e_2 + e_2^T R_2 e_2$$

Take  $V = V_1 + \alpha V_2$ ,  $\alpha > 0$ .

$$\dot{V} \leq y_1^T Q_1 y_1 - 2y_1^T S_1 y_2 + y_2^T R_1 y_2 + \alpha(y_2^T Q_2 y_2 + 2y_2^T S_2 y_1 + y_1^T R_2 y_1)$$

$$\dot{V} \leq \begin{bmatrix} y_1 \\ y_2 \end{bmatrix}^T \begin{bmatrix} Q_1 + \alpha R_2 & -S_1 + \alpha S_2^T \\ -S_1^T + \alpha S_2 & R_1 + \alpha Q_2 \end{bmatrix} \begin{bmatrix} y_1 \\ y_2 \end{bmatrix}$$

If the matrix is negative semidefinite, the origin is stable. If the matrix is negative definite,

$$\dot{V} = 0 \Rightarrow y = 0$$

By zero-state observability

$$y(t) \equiv 0 \Rightarrow x(t) \equiv 0$$

• 6.19 When  $u = 0$ , we have  $e_1 = u_1 - y_2 = -y_2$ ,  $e_2 = u_2 + y_2 = y_2$ , and  $e_1^T y_1 + e_2^T y_2 = u_1^T y_1 + u_2^T y_2 = 0$ . Use  $V = V_1 + V_2$  as a Lyapunov function candidate for the closed-loop system.

$$\begin{aligned} \dot{V} &\leq e_1^T y_1 - e_1^T \varphi_1(e_1) - y_1^T \rho_1(y_1) + e_2^T y_2 - e_2^T \varphi_2(e_2) - y_2^T \rho_2(y_2) \\ &= -[y_1^T \rho_1(y_1) + y_1^T \varphi_2(y_1)] - [y_2^T \rho_2(y_2) - y_2^T \varphi_1(-y_2)] \leq 0 \end{aligned}$$

$$\dot{V} = 0 \Rightarrow y_1[\rho_1(y_1) + \varphi_2(y_1)] = 0 \quad \text{and} \quad y_2^T[\rho_2(y_2) - \varphi_2(-y_2)] = 0 \Rightarrow y_1 = 0 \quad \text{and} \quad y_2 = 0$$

Now

$$y_1(t) \equiv 0 \Rightarrow e_2(t) \equiv 0 \quad \text{and} \quad y_2(t) \equiv 0 \Rightarrow e_1(t) \equiv 0$$

By zero-state observability,

$$y_1(t) \equiv 0 \Rightarrow x_1(t) \equiv 0 \quad \text{and} \quad y_2(t) \equiv 0 \Rightarrow x_2(t) \equiv 0$$

Hence, by the invariance principle, the origin is asymptotically stable. It will be globally asymptotically stable if  $V_1$  and  $V_2$  are radially unbounded.

## 《非线性系统（第三版）》习题解答

### Chapter 7

• 7.1 (1) The Nyquist plot of  $G(s)$  for  $\omega > 0$  is shown in Figure 7.1. It is a circle centered at  $(-\frac{1}{2}, 0)$  with radius equal to  $\frac{1}{2}$ . The plot for  $\omega < 0$  is identical; that is, the Nyquist plot traverses the circle twice as  $\omega$  changes from  $-\infty$  to  $\infty$ . The transfer function has two poles in the right-half plane. Thus, for absolute stability, the disk  $D(\alpha, \beta)$  must be inside the circle, so that the Nyquist plot encircles the disk twice in the counterclockwise direction. Clearly, the largest disk is the circle itself. Thus taking

$$\frac{-1}{\beta} = -\varepsilon_2, \text{ and } \frac{-1}{\alpha} = \frac{-1}{1 + \varepsilon_1}$$

where  $\varepsilon_1 > 0$  and  $\varepsilon_2 > 0$  are arbitrarily small, we conclude that the system is absolutely stable for the sector  $[1 + \varepsilon_1, 1/\varepsilon_2]$ .

(2) The Nyquist plot of  $G(s)$  for  $\omega > 0$  is shown in Figure 7.2. Since  $G(s)$  is Hurwitz we can apply case 2 or case 3 of the circle criterion. For case 2, we see that the Nyquist plot lies to the right of the vertical line through  $(-0.021, 0)$ . Thus the system is absolutely stable for the sector  $[0, 47.62]$ . For case 3, the Nyquist plot should be contained inside the disk  $D(\alpha, \beta)$ . We chose a circle of radius 0.114 centered at 0.0732. Thus,  $\alpha = -1/0.1871 = -5.34$ ,  $\beta = 1/0.0408 = 24.51$ , and the system is absolutely stable for the sector  $[-5.34, 24.51]$ .

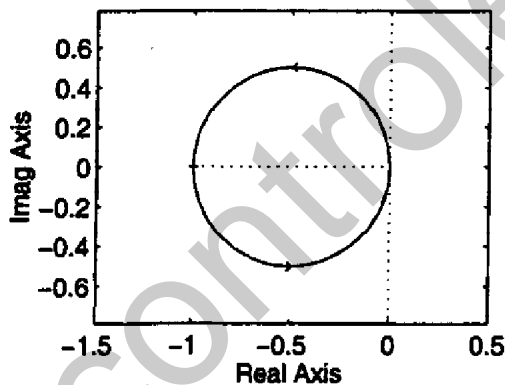

Figure 7.1: Exercise 7.1(1).

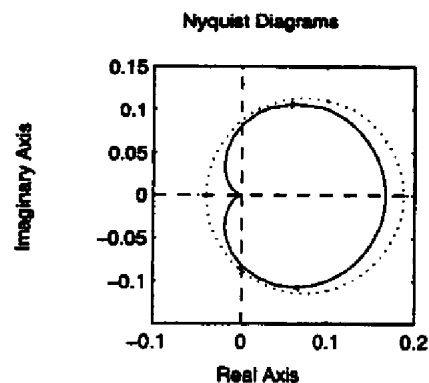

Figure 7.2: Exercise 7.1(2).

(3) The Nyquist plot is shown in Figure 7.3. Since  $G(s)$  is Hurwitz we can apply case 2 or case 3 of the circle criterion. For case 2, we see that the Nyquist plot lies to the right of the vertical line through  $(-0.35, 0)$ . Thus the system is absolutely stable for the sector  $[0, 2.857]$ . For case 3, the Nyquist plot should be contained inside the disk  $D(\alpha, \beta)$ . We chose a circle of radius 1.07 centered at 0.35. Thus,  $\alpha = -1/1.42 = -0.704$ ,  $\beta = 1/0.72 = 1.389$ , and the system is absolutely stable for the sector  $[-0.704, 1.389]$ .

## 《非线性系统（第三版）》习题解答

(4) The transfer function can be simplified to

$$G(s) = \frac{s-1}{s^2+1}$$

It has poles on the imaginary axis. We close the loop around  $G(s)$  with  $\alpha$ . the transformed transfer function

$$G_T(s) = \frac{G(s)}{1+\alpha G(s)} = \frac{1-s}{s^2+(\alpha-1)s+1}$$

is Hurwitz for  $0 < \alpha < 1$ . Take  $\alpha = 0.1$ . The Nyquist plot of  $G_T(s)$  is shown in Figure 7.4. It lies to the right of the vertical line through  $(-2.76, 0)$ . Thus the system is absolutely stable for the sector  $[0.1, 0.4632]$ .

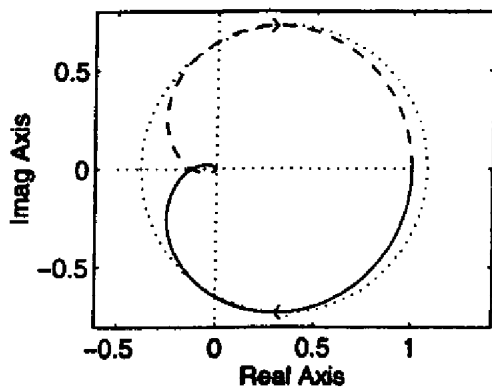

Figure 7.3: Exercise 7.1(3).

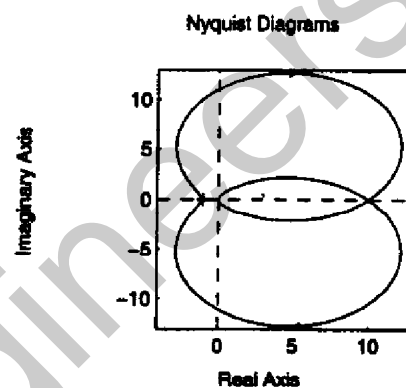

Figure 7.4: Exercise 7.1(4).

(5) The Nyquist plot is shown in Figure 7.5. The transfer function is Hurwitz. Therefore, we can apply cases 2 and 3 of the circle criterion. We start with case 2. From the Nyquist plot we find that  $\min\{\text{Re}\{G(j\omega)\}\} > -0.6$ . So we choose  $\beta = 1/0.6 = 1.67$  and conclude that the system is absolutely stable for the sector  $[0, 1.67]$ . Now we apply case 3 of the circle criterion. The Nyquist plot should be inside the disk  $D(\alpha, \beta)$ . We locate the center of the disk at  $(0.2, 0)$  and take the radius as 0.9. The circle is shown in Figure 7.5 (dotted line). Thus,  $1/\alpha = -1.1 \Rightarrow \alpha = -0.91$ ,  $1/\beta = 0.7 \Rightarrow \beta = 1.43$ , and the system is absolutely stable for the sector  $[-0.91, 1.43]$ .

(6) The Nyquist plot is shown in Figure 7.6. Since  $G(s)$  has one pole in the right-half plane, we apply case 1 of the circle criterion. The Nyquist plot should encircle the disk  $D(\alpha, \beta)$  once CCW. We chose a circle of radius 0.09 centered at  $(-0.16, 0)$ . Thus,  $\alpha = 1/0.25 = 4$ ,  $\beta = 1/0.07 = 14.29$ , and the system is absolutely stable for the sector  $[4, 14.29]$ .

(7) The Nyquist plot is shown in Figure 7.7. The transfer function is Hurwitz. Therefore, we can apply cases 2 and 3 of the circle criterion. We start with case 2. From the Nyquist plot we find that  $\min\{\text{Re}\{G(j\omega)\}\} > -0.341$ . So we choose  $\beta = 1/0.341 = 2.93$  and conclude that the system is absolutely stable for the sector  $[0, 2.93]$ . Now we apply case 3 of the circle criterion. The Nyquist plot should be inside the disk  $D(\alpha, \beta)$ . We locate the center of the disk at  $(0.3, 0)$  and take the radius as 0.8. The circle is shown in Figure 7.7 (dotted line). Thus,  $1/\alpha = -1.1 \Rightarrow \alpha = -0.91$ ,  $1/\beta = 0.5 \Rightarrow \beta = 2$ , and the system is absolutely stable for the sector  $[-0.91, 2]$ .

(8) The Nyquist plot is shown in Figure 7.8. The transfer function is Hurwitz. Therefore, we can apply cases 2 and 3 of the circle criterion. We start with case 2. From the Nyquist plot we find that  $\min\{\text{Re}\{G(j\omega)\}\} > -0.08$ . So we choose  $\beta = 1/0.08 = 12.5$  and conclude that the system is absolutely stable for the sector  $[0, 12.5]$ . Now we apply case 3 of the circle criterion. The Nyquist plot should be inside the disk  $D(\alpha, \beta)$ .

## 《非线性系统（第三版）》习题解答

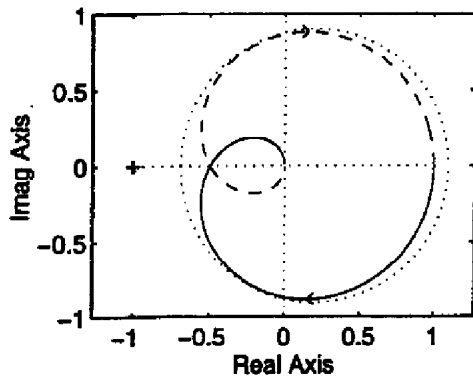

Figure 7.5: Exercise 7.1(5).

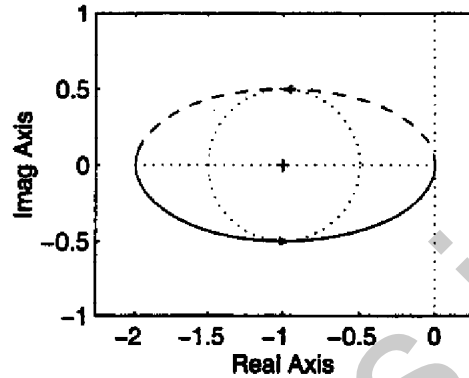

Figure 7.6: Exercise 7.1(6).

We locate the center of the disk at  $(0.1, 0)$  and take the radius as  $0.21$ . The circle is shown in Figure 7.8 (dotted line). Thus,  $1/\alpha = -0.31 \Rightarrow \alpha = -3.223$ ,  $1/\beta = 0.11 \Rightarrow \beta = 9.1$ , and the system is absolutely stable for the sector  $[-0.31, 9.1]$ .

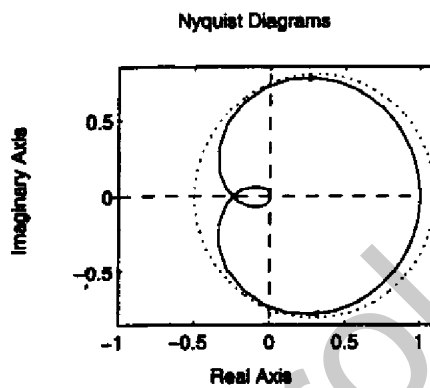

Figure 7.7: Exercise 7.1(7).

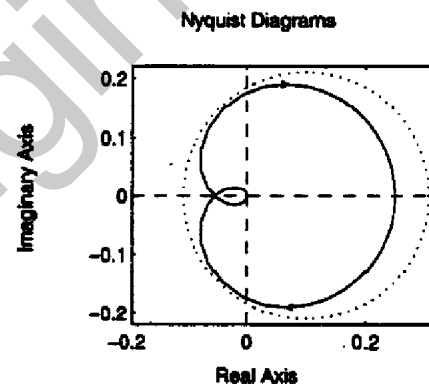

Figure 7.8: Exercise 7.1(8).

### • 7.2

(a) The Nyquist plot is shown in Figure 7.9. The plot lies entirely in the right-half plane. By case 2 of the circle criterion, we conclude that the system is absolutely stable for the sector  $[0, \beta]$ , where  $\beta$  can be made arbitrarily large. Consequently, the system is absolutely stable for the sector  $[0, 1]$ .

(b) The nonlinearity  $\text{sat}(y)$  belongs to the sector  $[0, 1]$ . Hence, the system has a globally exponentially stable equilibrium point at the origin. This implies that there can be no periodic solutions, since every solution must converge to the origin.

• 7.3 (a) The equilibrium points are the roots of the equations

$$0 = -x_1 - h(x_1 + x_2), \quad 0 = x_1 - x_2 - 2h(x_1 + x_2)$$

Multiply the first equation by  $-2$  and add to the second equation to obtain the equation

$$0 = -(x_1 + x_2) - 4h(x_1 + x_2)$$

## 《非线性系统（第三版）》习题解答

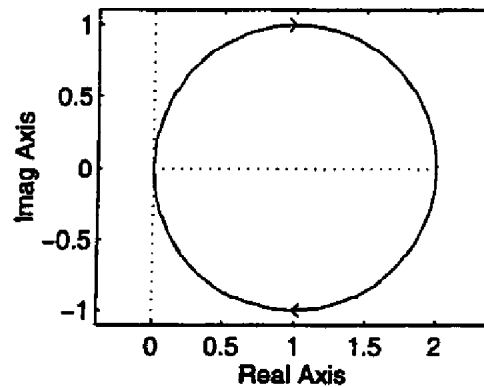

Figure 7.9: Exercise 7.2.

which has the unique solution  $x_1 + x_2 = 0$  due to the properties of  $h$ .

$$x_1 + x_2 = 0 \Rightarrow h(x_1 + x_2) = 0 \Rightarrow x_1 = 0 \Rightarrow x_2 = 0$$

Hence, the origin is the unique equilibrium point.

(b) Let  $y = x_1 + x_2$  and  $u = -h(x_1 + x_2)$ . Rewrite the system equation as

$$\begin{aligned} \dot{x}_1 &= -x_1 + u \\ \dot{x}_2 &= x_1 - x_2 + 2u \\ y &= x_1 + x_2 \\ u &= -h(x_1 + x_2) \end{aligned}$$

The system is now modeled as a feedback connection with the transfer function

$$G(s) = \frac{3s + 4}{(s + 1)^2}$$

and the nonlinear element  $\psi(y) = h(y)$ . The Nyquist plot of  $G(s)$  lies completely in the right-half plane. Hence, by the circle criterion, the system is absolutely stable for the sector  $[0, \beta]$ , where  $\beta$  can be arbitrarily large. This sector includes the nonlinearity  $h$ . Thus, the origin is globally asymptotically stable.

• 7.4 Let  $y = x_1$  and  $u = -q \cos \omega t x_1$ . Rewrite the system equation as

$$\begin{aligned} \dot{x}_1 &= x_2 \\ \dot{x}_2 &= -(\mu^2 + a^2)x_1 - 2\mu x_2 + u \\ y &= x_1 \\ u &= -q \cos \omega t y \end{aligned}$$

The system is now modeled as a feedback connection with

$$G(s) = \frac{1}{s^2 + 2\mu s + \mu^2 + a^2}$$

and  $\psi(t, y) = q \cos \omega t y$ . The function  $\psi$  belongs to the sector  $[-q, q]$ . We will apply the result of Example 7.1. We have  $|\psi(t, y)| \leq \gamma_2 |y|$  with  $\gamma_2 = q$ . We also have

$$|G(j\omega)|^2 = \frac{1}{(\mu^2 + a^2)^2 + 2\omega^2(\mu^2 - a^2) + \omega^4}$$



## 《非线性系统（第三版）》习题解答

It can be verified that

$$\gamma_1 = \sup_{\omega \in \mathbb{R}} |G(j\omega)| = \begin{cases} \frac{1}{\mu^2 + a^2}, & \text{for } \mu \geq a \\ \frac{1}{2\mu a}, & \text{for } \mu < a \end{cases}$$

The system is absolutely stable if  $q\gamma_1 < 1$ . Since the system is linear, this condition ensures that the origin is exponentially stable.

• 7.5 Represent the system as

$$\dot{x} = Ax + Bu, \quad y = Cx, \quad u = E(t)Cx = E(t)y \stackrel{\text{def}}{=} -\psi(t, y)$$

This problem is a special case of Example 7.1, with

$$\|\psi(t, y)\|_2 \leq \|E(t)\|_2 \|y\|_2 \leq \|y\|_2 \Rightarrow \gamma_2 = 1$$

and

$$\gamma_1 = \sup_{\omega \in \mathbb{R}} \sigma_{\max}[G(j\omega)] < 1$$

The condition for absolute stability ( $\gamma_1\gamma_2 < 1$ ) is satisfied. Hence, the origin is uniformly asymptotically stable.

• 7.6

(a) The closed-loop state equation is

$$\dot{x} = Ax + BL\text{sat}(-Fx/L) = (A - BF)x + B[Fx - L\text{sat}(Fx/L)]$$

Setting  $y = Fx$  and  $\psi(y) = L\text{sat}(y/L) - y$ , we represent the system as

$$\dot{x} = (A - BF)x - B\psi(y), \quad y = Fx$$

which is in the form of Figure 7.1 of the text, with  $G(s) = F(sI - A + BF)^{-1}B$ .

(b) We have

$$|\psi_i(y)| \leq \frac{\delta}{1 + \delta} |y_i|, \quad \forall |y_i| \leq L(1 + \delta)$$

Hence

$$\|\psi(y)\|_2 = \sqrt{\sum_{i=1}^m |\psi_i(y)|^2} \leq \frac{\delta}{1 + \delta} \|y\|_2$$

This is a special case of Example 7.1, with

$$\gamma_2 = \frac{\delta}{1 + \delta}, \quad \text{and } \gamma_1 = \sup_{\omega \in \mathbb{R}} \|G(j\omega)\|_2$$

Hence, the system is absolutely stable with a finite domain if

$$\frac{\delta}{1 + \delta} \sup_{\omega \in \mathbb{R}} \|G(j\omega)\|_2 < 1$$

(c)

$$G(s) = \frac{2s + 1}{s^2 + s + 0.5}$$

It can be checked that  $\sup |G(j\omega)| \leq 2.55$ . Hence, the system is absolutely stable with a finite domain if

$$\frac{\delta}{1 + \delta} < \frac{1}{2.55} \Rightarrow \delta < 0.6452$$

## 《非线性系统（第三版）》习题解答

To estimate the region of attraction, we apply the loop transformation of Figure 7.3 of the text.

$$u = \bar{u} - K_1 y = \bar{u} + \gamma_2 y, \quad \bar{y} = Ky + \hat{u} = 2\gamma_2 y + \bar{u}$$

The state model of the transformed system is

$$\begin{aligned} \dot{x} &= (A - BF + \gamma_2 BF)x + B\bar{u} \\ \bar{y} &= 2\gamma_2 Fx + \bar{u} \\ \bar{u} &= -\bar{\psi}(\bar{y}) \end{aligned}$$

where  $\bar{\psi} \in [0, \infty]$ . We need to find a matrix  $P$  that satisfies (7.6)–(7.8) for the transformed system. Equations (7.6)–(7.8) take the form

$$\begin{aligned} P(A - BF + \gamma_2 BF) + (A - BF + \gamma_2 BF)^T P &= -L^T L - \varepsilon P \\ PB &= 2\gamma_2 F^T - \sqrt{2}L^T \end{aligned}$$

It can be verified that

$$\varepsilon = 0.002, \quad P = \begin{bmatrix} 0.4638 & 0.3757 \\ 0.3757 & 2.2338 \end{bmatrix}, \quad \text{and } L = \begin{bmatrix} 0.2859 & -0.4764 \end{bmatrix}$$

satisfy (7.6)–(7.8). The region of attraction can be estimated using  $V(x) = x^T P x$ , as in Example 7.4.

• **7.7 (1)** The transfer function has poles in the right-half plane. Therefore, we start by applying a loop transformation. We close the loop around  $G(s)$  with  $\alpha$ . The transformed transfer function is

$$G_T(s) = \frac{G(s)}{1 + \alpha G(s)} = \frac{s}{s^2 + (\alpha - 1)s + 1}$$

Take  $\alpha = 1.1$ . The Popov plot of  $G_T(s)$  is shown in Figure 7.10. The largest sector is obtained with  $\gamma = 0$  so that the line of slope  $1/\gamma$  is vertical and intersects the horizontal axis at a point arbitrarily close to zero. The transformed system is absolutely stable for the sector  $[0, k]$ , where  $k$  can be arbitrarily large. Hence, the original system is absolutely stable for the sector  $[1.1, \beta]$ , where  $\beta$  can be arbitrarily large.

(2)  $G(s)$  is Hurwitz. Its Popov plot is shown in Figure 7.11. The Popov plot approaches the origin tangent to a line whose slope is 4.926. We take  $\gamma = 1/4.926 = 0.203$  and  $k > 0$  can be arbitrarily large. Let us verify that  $\gamma = 0.203$  is acceptable. Since  $G(s)$  has relative degree two, the product  $CB$  is zero in any state-space realization of  $G(s)$ . Thus, the condition  $2/k + \gamma CB + \gamma B^T C^T \geq 0$  is always satisfied. The poles of  $G(s)$  are  $-2$  and  $-3$ . Thus the condition  $1 + \gamma\lambda \neq 0$  is satisfied for  $\gamma = 0.203$ . We conclude that the given system is absolutely stable for the sector  $[0, k]$  where  $k$  is arbitrarily large.<sup>1</sup>

(3)  $G(s)$  is Hurwitz. Its Popov plot is shown in Figure 7.12. The Popov plot approaches the origin tangent to a line whose slope is 1. We take  $\gamma = 1$  and  $k > 0$  can be arbitrarily large. Let us verify that  $\gamma = 1$  is acceptable. Since  $G(s)$  has relative degree two, the product  $CB$  is zero in any state-space realization of  $G(s)$ . Thus, the condition  $2/k + \gamma CB + \gamma B^T C^T \geq 0$  is always satisfied. The poles of  $G(s)$  are  $-0.5 \pm j0.5\sqrt{3}$ . Thus the condition  $1 + \gamma\lambda \neq 0$  is satisfied for  $\gamma = 1$ . We conclude that the given system is absolutely stable for the sector  $[0, k]$  where  $k$  is arbitrarily large. We can obtain a sector with  $\alpha < 0$  by applying a loop transformation. Using the Routh-Hurwitz criterion, it can be shown that  $G_T(s) = G(s)/[1 + \alpha G(s)]$  is Hurwitz if  $\alpha > -1$ . Take  $\alpha = -0.9$  to obtain  $G_T(s) = 1/(s^2 + s + 0.1)$ . The Popov plot of  $G_T(s)$  is shown in Figure 7.13. The Popov plot approaches the origin tangent to a line whose slope is 1. We take  $\gamma = 1$  and  $k > 0$  can be arbitrarily large. Let us verify that  $\gamma = 1$  is acceptable. Since  $G_T(s)$  has relative degree two, the product  $CB$  is zero in any state-space realization of  $G_T(s)$ . Thus, the condition  $2/k + \gamma CB + \gamma B^T C^T \geq 0$  is always satisfied. The poles of  $G_T(s)$  are  $-0.1127$  and  $-0.8873$ . Thus the condition  $1 + \gamma\lambda \neq 0$  is satisfied for  $\gamma = 1$ . We conclude that the given system is absolutely stable for the sector  $[-0.9, k]$  where  $k$  is arbitrarily large. Compare these sectors with the ones obtained using the circle criterion in Exercise 7.1.

## 《非线性系统（第三版）》习题解答

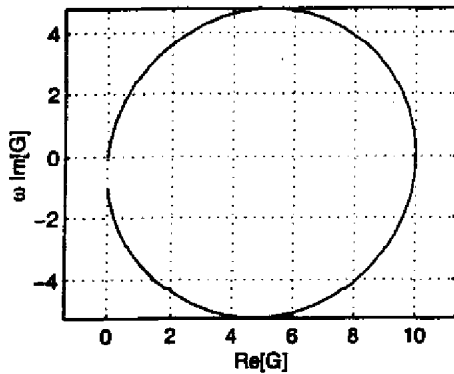

Figure 7.10: Exercise 7.7(1).

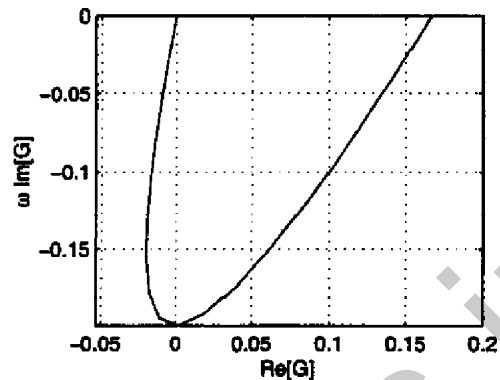

Figure 7.11: Exercise 7.7(2).

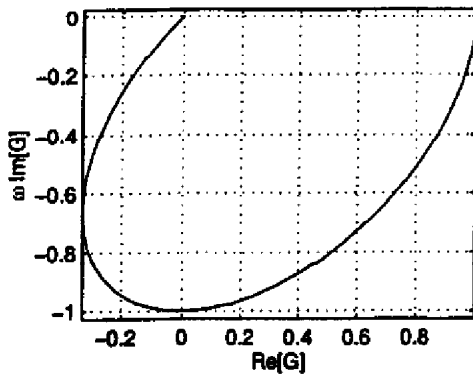

Figure 7.12: Exercise 7.7(3).

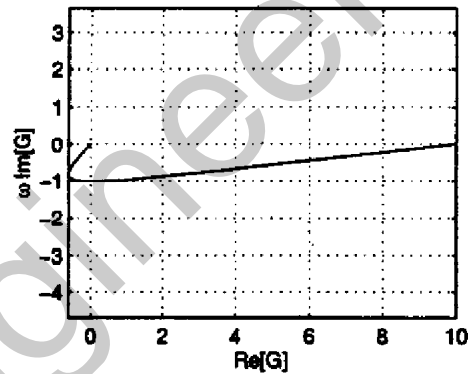

Figure 7.13: Exercise 7.7(3).

(4) The transfer function can be simplified to

$$G(s) = \frac{s-1}{s^2+1}$$

It has poles on the imaginary axis. We close the loop around  $G(s)$  with  $\alpha$ . the transformed transfer function

$$G_T(s) = \frac{G(s)}{1+\alpha G(s)} = \frac{1-s}{s^2+(\alpha-1)s+1}$$

is Hurwitz for  $0 < \alpha < 1$ . Take  $\alpha = 0.1$ . The Popov plot is shown in Figure 7.14. The Popov plot lies to the right of the vertical line through  $(-2.76, 0)$ . Thus, we take  $\gamma = 0$  and  $k = 1/2.76 = 0.3623$ . Therefore, the system is absolutely stable for the sector  $[0.1, 0.4623]$ . This is the same sector obtained by using the circle criterion because  $\gamma = 0$ .

(5) The Popov plot is shown in Figure 7.15. It lies to the right of (and tangent to) a line through  $(-0.5, 0)$  whose slope is 3. Thus, we take  $\gamma = 1/3$  and  $k = 1/0.505 = 1.98$ . Let us verify that  $\gamma = 1/3$  is acceptable. Expanding  $G(s)$  as a power series in  $1/s$ , it can be seen that the coefficient of  $1/s$  is  $-1$ . Therefore, in any state-space realization of  $G(s)$ ,  $CB = -1$ . Thus,  $2/k + \gamma CB + \gamma B^T C^T = 0.3433 > 0$ . The poles of  $G(s)$  are  $-1$  and  $-1$ . Thus,  $1 + \gamma\lambda = 2/3 \neq 0$ . Hence, the system is absolutely stable for the sector  $[0, 1.98]$ .

<sup>1</sup>We can also show absolute stability with a sector  $[\alpha, \beta]$  where  $\alpha$  is negative by applying a loop transformation. See the solution of part (3).

## 《非线性系统（第三版）》习题解答

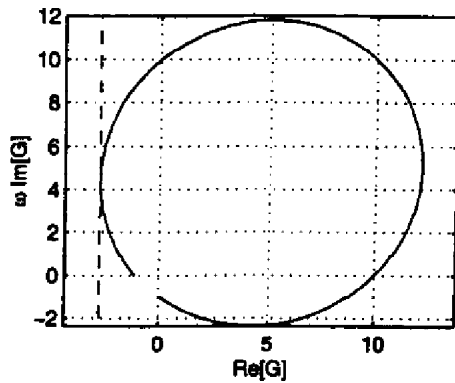

Figure 7.14: Exercise 7.7(4).

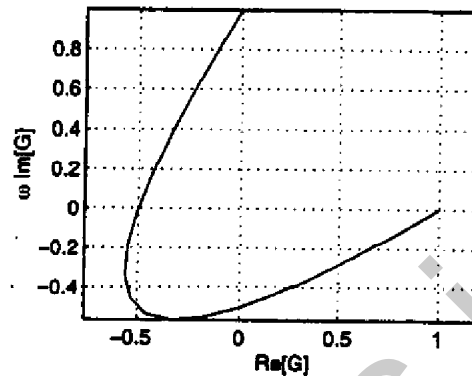

Figure 7.15: Exercise 7.7(5).

(6)  $G(s)$  is not Hurwitz. We need to apply a loop transformation with  $\alpha > 0$  such that  $G_T(s) = G(s)/[1 + \alpha G(s)]$  is Hurwitz. Using the Routh-Hurwitz criterion, it can be shown that  $G_T(s)$  is Hurwitz if  $\alpha > 4$ . Take  $\alpha = 4.1$  to obtain  $G_T(s) = (s+1)/(s^3 + 3s^2 + 4.1s + 0.1)$ . The Popov plot of  $G_T(s)$  is shown in Figure 7.16. The Popov plot approaches the origin tangent to a line whose slope is 2. We take  $\gamma = 0.5$  and  $k > 0$  can be arbitrarily large. Let us verify that  $\gamma = 0.5$  is acceptable. Since  $G_T(s)$  has relative degree two, the product  $CB$  is zero in any state-space realization of  $G_T(s)$ . Thus, the condition  $2/k + \gamma CB + \gamma B^T C^T \geq 0$  is always satisfied. The poles of  $G_T(s)$  are  $-0.0248$  and  $-1.4876 \pm j1.3466$ . Thus the condition  $1 + \gamma\lambda \neq 0$  is satisfied for  $\gamma = 0.5$ . We conclude that the given system is absolutely stable for the sector  $[4.1, k]$  where  $k$  is arbitrarily large. Compare this sector with the one obtained using the circle criterion in Exercise 7.1.

(7) The Popov plot is shown in Figure 7.17. It lies to the right of (and tangent to) a line through  $(-0.25, 0)$  whose slope is 1. Thus, we take  $\gamma = 1$  and  $k = 1/0.2505 = 3.99$ . Let us verify that  $\gamma = 1$  is acceptable. Since  $G(s)$  has relative degree four, the product  $CB$  is zero in any state-space realization of  $G(s)$ . Thus, the condition  $2/k + \gamma CB + \gamma B^T C^T \geq 0$  is always satisfied. The poles of  $G(s)$  are at  $-1$ . Hence,  $\gamma = 1$  does not satisfy the condition  $1 + \gamma\lambda \neq 0$ . We take  $\gamma = 1.01$ . It can be verified that the Popov plot lies to the right of the line through  $(-0.2505, 0)$  whose slope is  $1/1.01 = 0.99$  (see Figure 7.17). Thus, the system is absolutely stable for the sector  $[0, 3.99]$ .

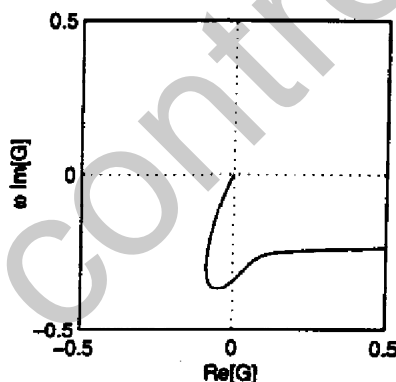

Figure 7.16: Exercise 7.7(6).

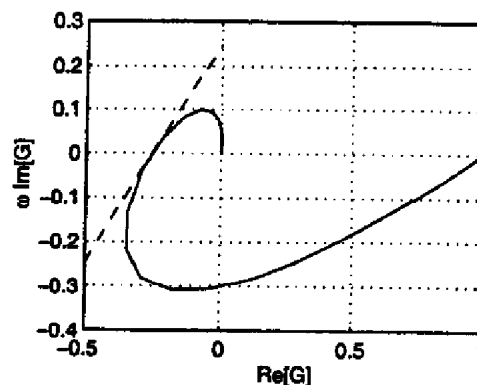

Figure 7.17: Exercise 7.7(7).

(8) The Popov plot is shown in Figure 7.18. It lies to the right of (and tangent to) a line through  $(-0.0556, 0)$  whose slope is 1.6. Thus, we take  $\gamma = 1/1.6 = 0.625$  and  $k = 1/0.056 = 17.86$ . Let us verify that  $\gamma = 0.625$

## 《非线性系统（第三版）》习题解答

is acceptable. Since  $G(s)$  has relative degree four, the product  $CB$  is zero in any state-space realization of  $G(s)$ . Thus, the condition  $2/k + \gamma CB + \gamma B^T C^T \geq 0$  is always satisfied. The poles of  $G(s)$  are at  $-1$  and  $-2$ . Hence, the condition  $1 + \gamma \lambda \neq 0$  is satisfied for  $\gamma = 0.625$ . Thus, the system is absolutely stable for the sector  $[0, 17.86]$ .

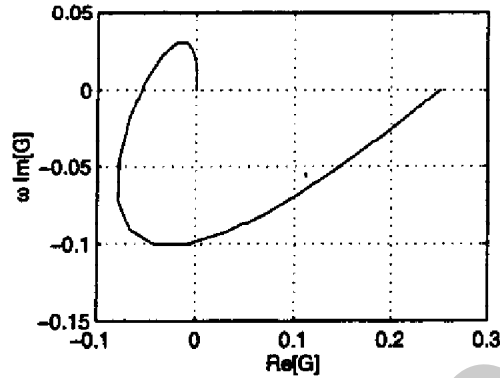

Figure 7.18: Exercise 7.7(8).

- 7.8 (a) Write  $V$  as

$$V = z^T P z + a d^2 v^2 + b \int_0^v \psi(\sigma) d\sigma$$

Since  $P = P^T > 0$  and  $a d^2 > 0$ , the first two terms form a positive definite quadratic function of  $(z, v)$ . Since  $b \geq 0$  and  $\psi$  is a first quadrant-third quadrant nonlinearity, the integral term is nonnegative. Hence,  $V$  is positive definite. It is also radially unbounded since  $V(z, v) \geq z^T P z + a d v^2$ .

- (b)

$$\begin{aligned} \dot{V} &= z^T (PA + A^T P) z - 2z^T P B \psi - 2a d^2 v \dot{\psi} + b \psi (CAz - CB\psi - d\dot{\psi}) \\ &\leq z^T (PA + A^T P) z - 2z^T P B \psi - 2ad(y - Cz)\psi + b\psi CAz - bCB\psi^2 - bd\dot{\psi}^2 - \frac{2ad}{k}\psi(\dot{\psi} - ky) \\ &= z^T (PA + A^T P) z - 2z^T (PB - \frac{1}{2}bA^T C^T - adC^T)\psi - \left( bCB + bd + \frac{2ad}{k} \right) \psi^2 \\ &= z^T (PA + A^T P) z - 2z^T (PB - w)\psi - \gamma \psi^2 \end{aligned}$$

where

$$w = \frac{1}{2}bA^T C^T + adC^T, \quad \gamma = bCB + bd + \frac{2ad}{k}$$

Choose  $b$  such that  $\gamma \geq 0$ . Suppose there are  $P = P^T > 0$ ,  $L$  and  $\varepsilon > 0$  which satisfy

$$\begin{aligned} PA + A^T P &= -L^T L - \varepsilon P \\ PB &= w - L^T \sqrt{\gamma} \end{aligned}$$

Then

$$\begin{aligned} \dot{V} &\leq -\varepsilon z^T P z - z^T L^T L z + 2z^T L^T \sqrt{\gamma} \psi - \gamma \psi^2 \\ &= -\varepsilon z^T P z - (z^T L^T - \sqrt{\gamma} \psi)(Lz - \sqrt{\gamma} \psi) \leq -\varepsilon z^T P z \end{aligned}$$

## 《非线性系统（第三版）》习题解答

Hence,  $\dot{V}$  is negative semidefinite.

$$\dot{V} = 0 \Rightarrow z(t) \equiv 0 \Rightarrow \psi(y(t)) \equiv 0 \Rightarrow y(t) \equiv 0 \Rightarrow v(t) \equiv 0$$

Thus, by LaSalle's theorem, the origin is globally asymptotically stable. Now, by Lemma 6.3, the existence of  $P$ ,  $L$ , and  $\varepsilon$  satisfying the foregoing equations is equivalent to the strict positive realness of

$$\begin{aligned} Z(s) &= w^T (sI - A)^{-1} B + \frac{1}{2} \gamma \\ &= ad \left[ (C + \eta CA)(sI - A)^{-1} B + \frac{1}{k} + \eta(d + CB) \right] \end{aligned}$$

where  $\eta = b/2ad$ . By Lemma 6.1, we want  $\text{Re}[Z(j\omega)] > 0$  for all  $\omega$ , that is,

$$\frac{1}{k} + \text{Re}[(C + \eta CA)(j\omega I - A)^{-1} B + \eta(d + CB)] > 0$$

Noting that

$$\begin{aligned} (1 + \eta s)C(sI - A)^{-1} B &= C(sI - A)^{-1} B + \eta s C \left[ \frac{1}{s} I + \frac{1}{s^2} A + \dots \right] B \\ &= C(sI - A)^{-1} B + \eta CB + \eta CA \left[ \frac{1}{s} I + \frac{1}{s^2} A + \dots \right] B \\ &= (C + \eta CA)(sI - A)^{-1} B + \eta CB \end{aligned}$$

and

$$\text{Re} \left[ (1 + j\omega\eta) \frac{d}{j\omega} \right] = \eta d$$

we obtain

$$\text{Re}[(C + \eta CA)(j\omega I - A)^{-1} B + \eta(d + CB)] = \text{Re} \left\{ (1 + j\omega\eta) \left[ C(j\omega I - A)^{-1} B + \frac{d}{j\omega} \right] \right\}$$

and the condition for absolute stability reduces to

$$\frac{1}{k} + \text{Re}[(1 + j\omega\eta)G(j\omega)] > 0, \quad \forall \omega \in R$$

• 7.9 (a) From the block diagram, we have

$$E(s) = -Y(s) - kU_1(s) = -[H(s) + k]U_1(s) = -[H(s) + k] \frac{1}{s} U(s)$$

Hence, the system can be represented as the feedback connection of Figure 7.1 of the text with

$$G(s) = \frac{1}{s} [H(s) + k] = \frac{s + 6 + k(s + 2)(s + 3)}{s(s + 2)(s + 3)}$$

(b) From the Popov criterion (Exercise 7.8), the system is absolutely stable if

$$\frac{1}{\beta} + \text{Re}[(1 + j\omega\eta)G(j\omega)] > 0, \quad \forall \omega \in R$$

To simplify the calculations, choose  $\eta = \frac{1}{2}$ . Then

$$\text{Re}[(1 + j\omega\eta)G(j\omega)] = \frac{k\omega^2 + 9k - 3}{2(9 + \omega^2)}$$

which is positive for  $k > \frac{1}{3}$ . Thus, we take  $k_c = \frac{1}{3}$ .

## 《非线性系统（第三版）》习题解答

• 7.10

(1)

$$\Psi(a) = \frac{1}{\pi a} \int_0^\pi a^5 \sin^6 \theta \, d\theta$$

$$\sin^6 \theta = \left[ \frac{1}{2}(1 - \cos 2\theta) \right]^3 = \frac{1}{8}(1 - 3 \cos 2\theta + 3 \cos^2 2\theta - \cos^3 2\theta) = \frac{1}{8} \left( 1 - 3 \cos 2\theta + \frac{3}{2} + \frac{3}{2} \cos 4\theta - \cos^3 2\theta \right)$$

The terms  $\cos 2\theta$ ,  $\cos^3 2\theta$ , and  $\cos 4\theta$  integrate to zero over 0 to  $\pi$ . Thus

$$\Psi(a) = \frac{2}{\pi a} \int_0^\pi \frac{5a^5}{16} \, d\theta = \frac{5a^4}{8}$$

(2)

$$\Psi(a) = \frac{2}{\pi a} \int_0^\pi a^4 \sin^5 \theta \, d\theta$$

$$\int \sin^5 \theta \, d\theta = -\frac{1}{5} \sin^4 \theta \cos \theta - \frac{4}{15} \sin \theta \cos \theta - \frac{8}{15} \cos \theta$$

Upon substituting the limit from 0 to  $\pi$ , the first two terms vanish and the third term gives (16/15). Thus

$$\Psi(a) = \frac{32a^3}{15\pi}$$

(3) We can write the given function as  $\psi(y) = k + A \operatorname{sgn}(y)$ . The describing function of the signum nonlinearity is given in Example 7.6. Thus

$$\Psi(a) = k + \frac{4A}{\pi a}$$

(4) For  $a \leq A$ ,  $\psi(a \sin \theta) = 0 \Rightarrow \Psi(a) = 0$ . For  $a > A$ ,  $\psi(a \sin \theta)$  is given by

$$\psi(a \sin \theta) = \begin{cases} 0, & \text{for } 0 \leq \theta \leq \beta \text{ \& } \pi - \beta \leq \theta \leq \pi \\ B, & \text{for } \beta < \theta < \pi - \beta \end{cases}$$

where  $\beta = \sin^{-1}(A/a)$ . Thus

$$\Psi(a) = \frac{4}{\pi a} \int_\beta^{\pi/2} B \sin \theta \, d\theta = \frac{4B}{\pi a} \cos \beta = \frac{4B}{\pi a} \sqrt{1 - \frac{A^2}{a^2}}$$

(5) The given function can be written as  $\psi(y) = \psi_1(y) + \psi_2(y)$ , where

$$\psi_1(y) = \begin{cases} 0, & \text{if } 0 \leq y < A \\ k(y - A), & \text{if } y \geq A \end{cases} \quad \text{and} \quad \psi_2(y) = \begin{cases} 0, & \text{if } 0 \leq y < B \\ -k(y - B), & \text{if } y \geq B \end{cases}$$

$\psi_1$  and  $\psi_2$  are special cases of the function treated in Example 7.7. Using the result of that Example, we obtain

$$\Psi_1(a) = \begin{cases} 0, & \text{for } a \leq A \\ k - kN\left(\frac{a}{A}\right), & \text{for } a > A \end{cases}, \quad \Psi_2(a) = \begin{cases} 0, & \text{for } a \leq B \\ -k + kN\left(\frac{a}{B}\right), & \text{for } a > B \end{cases}$$

The sum  $\Psi_1(a) + \Psi_2(a)$  gives the desired describing function.

• 7.11 (1)

$$G(j\omega) = \frac{1 - j\omega}{j\omega(1 + j\omega)} = \frac{1 - \omega^2 - 2j\omega}{j\omega(1 + \omega^2)}$$

## 《非线性系统（第三版）》习题解答

$$\operatorname{Re}[G(j\omega)] = \frac{-2}{1+\omega^2}, \quad \operatorname{Im}[G(j\omega)] = \frac{-1+\omega^2}{\omega(1+\omega^2)}$$

$$\operatorname{Im}[G(j\omega)] = 0 \Rightarrow \omega = 1, \quad \operatorname{Re}[G(j)] = -1$$

For  $\psi(y) = y^5$ , we have  $\Psi(a) = 5a^4/8$ . The equation  $1 - \Psi(a) = 0$  has a unique solution  $a = (\frac{8}{5})^{\frac{1}{4}} = 1.125$ . There is a possibility of a periodic solution of amplitude close to 1.125 and frequency close to 1 rad/sec.

(2) The transfer function is the same as in part (1). The describing function is given by

$$\Psi(a) = \begin{cases} 0, & \text{for } a \leq 1 \\ 2[1 - N(a)], & \text{for } 1 \leq a \leq 1.5 \\ 2[N(a/1.5) - N(a)], & \text{for } a \geq 1.5 \end{cases}$$

By using Matlab, it can be checked that the equation  $1 - \Psi(a) = 0$  has no solution. So, we expect that the system will not have sustained oscillation.

(3)

$$\begin{aligned} G(j\omega) &= \frac{1}{(1+j\omega)^6} = \frac{(1-j\omega)^6}{(1+\omega^2)^6} \\ &= \frac{1+6(-j\omega)+15(-j\omega)^2+20(-j\omega)^3+15(-j\omega)^4+6(-j\omega)^5+(-j\omega)^6}{(1+\omega^2)^6} \\ &= \frac{1-15\omega^2+15\omega^4-\omega^6+j[-6\omega+20\omega^3-6\omega^5]}{(1+\omega^2)^6} \end{aligned}$$

$$\operatorname{Im}[G(j\omega)] = 0 \Rightarrow -6+20\omega^2-6\omega^4 = 0 \Rightarrow \omega^2 = 3 \text{ or } \omega^2 = \frac{1}{3}$$

$$\operatorname{Re}[G(j3)] = \frac{1}{64}, \quad \operatorname{Re}[G(j\frac{1}{3})] = -\frac{27}{64}$$

From Example 7.6, we know that  $\Psi(a) = 4/\pi a$ . For  $\omega^2 = 3$ , the equation  $1 + \Psi(a)\operatorname{Re}[G] = 0$  has no solution. For  $\omega^2 = \frac{1}{3}$ , the equation has a unique root  $a = 27/16\pi$ . Thus, we expect that the system will have a periodic solution with amplitude close to  $27/16\pi$  and frequency close to  $1/\sqrt{3}$  rad/sec.

(4)

$$G(j\omega) = \frac{j\omega+6}{j\omega(j\omega+2)(j\omega+3)} = \frac{-j(6+j\omega)(2-j\omega)(3-j\omega)}{\omega(4+\omega^2)(9+\omega^2)} = \frac{-\omega(24+\omega^2)-j(36-\omega^2)}{\omega(4+\omega^2)(9+\omega^2)}$$

$$\operatorname{Im}[G(j\omega)] = 0 \Rightarrow 36 - \omega^2 = 0 \Rightarrow \omega = 6$$

$\operatorname{Re}[G(j6)] = -1/30$  and the equation  $1 + \Psi(a)\operatorname{Re}G = 0$  has the unique solution  $a = 2/15\pi$ . Thus, we expect that the system will have a periodic solution with amplitude close to  $2/15\pi$  and frequency close to 6 rad/sec.

(5)

$$G(j\omega) = \frac{j\omega}{-\omega^2 - j\omega + 1} = \frac{j\omega}{1 - \omega^2 + j\omega} = \frac{-\omega^2 + j\omega(1 - \omega^2)}{(1 - \omega^2)^2 + \omega^2}$$

$$\operatorname{Im}[G(j\omega)] = 0 \Rightarrow \omega = 1$$

$\operatorname{Re}[G(j)] = -1$  and the equation  $1 + \Psi(a)\operatorname{Re}G = 0$  has the unique solution  $a = (8/5)^{1/4}$ . Thus, we expect that the system will have a periodic solution with amplitude close to  $(8/5)^{1/4}$  and frequency close to 1 rad/sec.

(6)

$$G(j\omega) = \frac{5(1+j4\omega)}{4(j\omega)^2(2+j\omega)^2} = \frac{5(1+4j\omega)(2-j\omega)^2}{-4\omega^2(4+\omega^2)^2} = \frac{5(4+15\omega^2)+j20\omega(3-\omega^2)}{-4\omega^2(4+\omega^2)^2}$$

$$\operatorname{Im}[G(j\omega)] = 0 \Rightarrow \omega(3 - \omega^2) = 0 \Rightarrow \omega = \sqrt{3}$$



## 《非线性系统（第三版）》习题解答

$\text{Re}[G(j\sqrt{3})] = -5/12$ . The equation  $1 + \Psi(a)\text{Re}G = 0$  yields  $\Psi(a) = 12/5$ .

$$\Psi(a) = 2 + \frac{4}{\pi a} = \frac{12}{5} \Rightarrow a = \frac{10}{\pi}$$

Thus, we expect that the system will have a periodic solution with amplitude close to  $10/\pi$  and frequency close to 1 rad/sec.

(7) From part (6), the equation  $1 + \Psi(a)\text{Re}G = 0$  has the unique solution  $a = (8/5)^{1/4}$ .

$$\Psi(a) = \begin{cases} 0, & \text{for } a \leq 1 \\ \frac{4}{\pi a} \sqrt{1 - (\frac{1}{a})^2}, & \text{for } a \geq 1 \end{cases}$$

$\Psi(a) \leq 4/\pi a$ . Hence,  $\Psi(a) = 12/5$  has no solution. Thus, we expect that the system will not have sustained oscillation.

(8) From part (6), the equation  $1 + \Psi(a)\text{Re}G = 0$  has the unique solution  $a = (8/5)^{1/4}$ . The describing function is given in the solution of part (2). By using Matlab, it can be verified that  $\Psi(a) = 12/5$  has no solution. Thus, we expect that the system will not have sustained oscillation.

(9)

$$G(j\omega) = \frac{1}{(1+j\omega)^3} = \frac{1-3\omega^2-j\omega(3-\omega^2)}{(1+\omega^2)^3}$$

$$\text{Im}[G(j\omega)] = 0 \Rightarrow \omega(3-\omega^2) = 0 \Rightarrow \omega = \sqrt{3}$$

$\text{Re}[G(j\sqrt{3})] = -1/8$ . The equation  $1 + \Psi(a)\text{Re}[G] = 0$  yields  $\Psi(a) = 8$ . From Example 7.6, the describing function of the signum function is  $\Psi(a) = 4/(\pi a)$ . The equation  $\Psi(a) = 8$  has the solution  $a = 1/(2\pi)$ . Thus, we expect that the system will have a periodic solution with amplitude close to  $1/(2\pi)$  and frequency close to  $\sqrt{3}$  rad/sec.

(10) From part (9),  $\Psi(a) = 8$ . From Example 7.7, the describing function of the saturation function satisfies  $\Psi(a) \leq 1$ . Thus,  $\Psi(a) = 8$  has no solution and we expect that the system will not have sustained oscillation.

• 7.12 With reference to Section 1.2.4, represent the negative resistance oscillator in the  $z$ -coordinates

$$\dot{z}_1 = z_2, \quad \dot{z}_2 = -z_1 - h(z_2)$$

where  $h(v) = -v + v^3 - \frac{1}{5}v^5$ . including the  $-v$  term with the linear system, we can represent the system in the form of Figure 7.1 with

$$A = \begin{bmatrix} 0 & 1 \\ -1 & 1 \end{bmatrix}, \quad B = \begin{bmatrix} 0 \\ 1 \end{bmatrix}, \quad C = [0 \quad 1], \quad \psi(y) = y^3 - \frac{1}{5}y^5$$

$$G(s) = C(sI - A)^{-1}B = \frac{s}{s^2 - s + 1}, \quad G(j\omega) = \frac{-\omega^2 + j\omega(1 - \omega^2)}{(1 - \omega^2)^2 + \omega^2}$$

$$\text{Im} G(j\omega) = 0 \Rightarrow \omega = 1$$

$$\text{Re} G(j) = -1 \Rightarrow \Psi(a) = 1$$

On the other hand,

$$\Psi(a) = \frac{2}{\pi a} \int_0^\pi \left[ (a \sin \theta)^3 - \frac{1}{5}(a \sin \theta)^5 \right] \sin \theta \, d\theta = \frac{3a^2}{4} - \frac{a^4}{8}$$

The equation  $\frac{3a^2}{4} - \frac{a^4}{8} = 1$  has two solutions:  $a = 2$  and  $a = \sqrt{2}$ . Thus the harmonic balance equation has two solutions:  $(\omega_s, a_s) = (1, 2)$  and  $(\omega_s, a_s) = (1, \sqrt{2})$ . We expect that the system will have two periodic solutions, the first one has amplitude close to 2 and frequency close to 1 rad/sec, and the second one has

## 《非线性系统（第三版）》习题解答

amplitude close to  $\sqrt{a}$  and frequency close to 1 rad/sec. The phase portrait (Figure 7.19) shows that the system has two limit cycles. The amplitude of  $z_2$  in the inner limit cycle is about 1.4 while that of the outer limit cycle is about 2. These numbers correlate reasonably well with the estimates of the amplitude of the first harmonic obtained using the describing function method. From Figure 7.20, we can estimate the frequency of oscillation by 0.9657 rad/sec, which is close to the frequency of oscillation predicted by the describing function method.

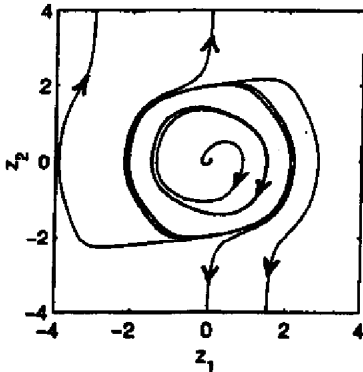

Figure 7.19: Exercise 7.12.

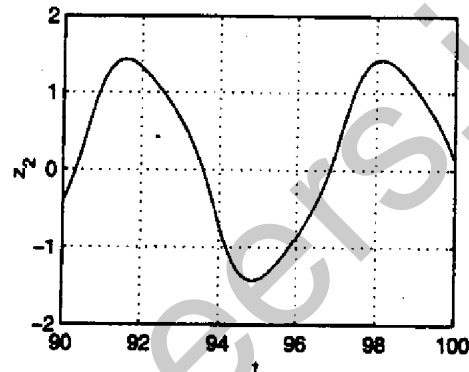

Figure 7.20: Exercise 7.12.

### • 7.13

$$G(j\omega) = \frac{2bj\omega}{1 - \omega^2 - jb\omega} = \frac{-2b^2\omega^2 + j2b\omega(1 - \omega^2)}{(1 - \omega^2)^2 + b^2\omega^2}$$

$$\text{Im}[G(j\omega)] = 0 \Rightarrow \omega = 1$$

$\text{Re}[G(j)] = -2$ . The equation  $1 + \Psi(a)\text{Re}G = 0$  yields  $\Psi(a) = \frac{1}{2}$ . The describing function of the saturation nonlinearity is given in Example 7.7. By using Matlab, it can be verified that  $\Psi(a) = \frac{1}{2}$  has a solution  $a = 2.47$ . Thus, we expect that the system will have a periodic solution with amplitude close to 2.47 and frequency close to 1 rad/sec. To confirm this conjecture, we apply Theorem 7.4. The saturation nonlinearity satisfies the slope restriction with  $\alpha = 0$  and  $\beta = 1$ .

$$\frac{1}{G(j\omega)} = \frac{1 - \omega^2 - jb\omega}{2bj\omega} = -\frac{1}{2} - j\left(\frac{1 - \omega^2}{2b\omega}\right)$$

The inverse Nyquist plot is a vertical line through the point  $(-0.5, 0)$ . The critical circle has its center at the point  $(-0.5, 0)$  and its radius is 0.5. The inverse Nyquist plot intersects the critical circle at the points  $(-0.5, -0.5)$  and  $(-0.5, 0.5)$ . The frequencies at these two points are given, approximately, by  $\omega = 1 - b/2$  and  $\omega = 1 + b/2$ . So, we limit our analysis to the frequency band  $\omega \in [1 - b/2, 1 + b/2]$ .

$$\left| \frac{\alpha + \beta}{2} + \frac{1}{G(j\omega)} \right| = \left| \frac{1 - \omega^2}{j2b\omega} \right|$$

For  $\omega > 1$ , the right-hand side is a monotonically increasing function of  $\omega$ . Hence,  $\rho(\omega)$  is calculated at  $k = 3$  to be

$$\rho(\omega) = \frac{9\omega^2 - 1}{6b\omega}$$

For  $1 \leq \omega \leq 1 + b/2$ ,

$$\frac{4}{3b} \leq \rho(\omega) \leq \frac{9(1 + b/2)^2 - 1}{6b(1 + b/2)} \approx \frac{4}{3b} \left( \frac{1 + 9b/8}{1 + b/2} \right)$$

## 《非线性系统（第三版）》习题解答

Thus, for small  $b$ ,  $\rho(\omega)$  is of order  $O(1/b)$ . Consequently,

$$\sigma(\omega) = \frac{(0.5)^2}{\rho(\omega) - 0.5} \approx \frac{3b}{16} = O(b)$$

The uncertainty band will be very narrow for sufficiently small  $b$ . It can be verified that the uncertainty band defines a complete intersection. Theorem 7.4 confirms that there is a half-wave symmetric periodic solution. The amplitude of oscillation will be  $O(b)$  close to 2.47 and the frequency of oscillation will be  $O(b)$  close to 1 rad/sec.

• 7.14 (a)  $\psi \in [0, b]$ . Since  $G(s)$  is Hurwitz, we apply case 2 of the circle criterion. From the Nyquist plot, we see that  $\text{Re}[G(j\omega)] \geq -0.085$ . Thus, the largest  $b$  is  $b = 1/0.085 = 11.76$ .

(b) The Popov plot lies to the right of a line having slope = 1.2 and intersecting the real axis at  $-0.06$ . The slope corresponds to  $\gamma = 1/1.2 = 0.833$ . Since the eigenvalues of  $A$  are at  $-1$  and  $-2$ , the condition  $(1 + \lambda\gamma) \neq 0$  is satisfied. Also, since  $G(s)$  has relative degree higher than one,  $CB = 0$ . Hence, the condition  $2 + 2\gamma kCB > 0$  is satisfied for any  $\gamma$ . Thus, the choice  $\gamma = 0.833$  is acceptable and the largest  $b$  is  $b = 1/0.06 = 16.67$ .

(c)  $\psi$  is a special case of the piecewise linear function of Example 7.7 with  $s_1 = b$ ,  $s_2 = 0$ , and  $\delta = 1/b$ . The describing function is

$$\Psi(a) = \frac{2b}{\pi} \left[ \sin^{-1} \left( \frac{1}{ab} \right) + \frac{1}{ab} \sqrt{1 - \left( \frac{1}{ab} \right)^2} \right]$$

$$G(j\omega) = \frac{(1 - \omega^2 - 2j\omega)(4 - \omega^2 - 4j\omega)}{(1 + \omega^2)^2(4 + \omega^2)^2}$$

$$\text{Im}[G(j\omega)] = \frac{-2\omega(6 - 3\omega^2)}{(\cdot)} = 0 \Rightarrow \omega = \sqrt{2}$$

$$1 + \Psi(a)\text{Re}[G(j\sqrt{2})] = 0 \Rightarrow \Psi(a) = 18$$

Because  $\psi(a)$  starts from  $b$  at  $a = 0$  and decreases after  $a = 1/b$ , the equation  $\psi(a) = 18$  has a solution if  $b > 18$ . The frequency of oscillation will be close to  $\omega = \sqrt{2}$ .

(d) For  $b = 10$ , the slope restrictions are  $\alpha = 0$  and  $\beta = 10$ . The inverse Nyquist plot and the critical circle are shown in Figure 7.21. The inverse Nyquist plot is plotted only for  $\omega \in [0, 2]$ . It keeps moving farther away for higher frequencies. Because the inverse Nyquist plot is always outside the critical circle, there is no oscillation.

(e) For  $b = 30$ , the slope restrictions are  $\alpha = 0$  and  $\beta = 30$ . The inverse Nyquist plot and the critical circle are shown in Figure 7.23. The error circle are plotted for the following points:

$\omega$	$1/G(j\omega)$	$\sigma(\omega)$
1.3	(-15.1139, 2.418)	0.7536
1.389	(-17.3589, 0.589)	0.5911
1.436	(-18.555, -0.535)	0.5231
1.45	(-18.912, -0.8917)	0.5048
1.5	(-20.1875, -2.25)	0.4456

The circles tangent to the real axis correspond to  $\omega = 1.389$  and  $\omega = 1.436$ . Thus,  $\omega_1 = 1.389$  rad/sec and  $\omega_2 = 1.436$  rad/sec. The boundaries of the band of uncertainty intersects the real axis at  $-17$  and  $-18.75$ . By plotting  $\Psi(a)$  versus  $a$ , the values of  $a_1$  and  $a_2$  are determined as  $a_1 = 0.0649$  and  $a_2 = 0.0721$ . It can be verified that the regularity conditions are satisfied. Therefore, there is oscillation of frequency  $\omega \in [1.389, 1.436]$  and the amplitude of the first harmonic of the output is  $a \in [0.0649, 0.0721]$ . At  $\omega = 1.389$  and  $a = 0.0721$ , we have

$$\frac{\omega}{\pi} \int_0^{2\pi/\omega} y_h^2(t) dt \leq \left[ \frac{2 \times 0.5911 \times 0.0721}{30} \right]^2 = 8 \times 10^{-8}$$

## 《非线性系统（第三版）》习题解答

The energy content in the first harmonic is

$$\frac{\omega}{\pi} \int_0^{2\pi/\omega} a^2 \sin^2(\omega t) dt = a^2 = (0.0721)^2 = 0.52 \times 10^{-2}$$

the ratio is  $15.38 \times 10^{-4}$ . Taking the square root, the percentage of the higher harmonics to the first one is 3.9%. The simulation is shown in Figure 7.22. The simulation shows a period of oscillation of about 4.4 sec., that is,  $\omega \approx 1.428$  rad/sec. The amplitude of oscillation is about 0.068. These results are consistent with the ones we obtained using the describing function method.

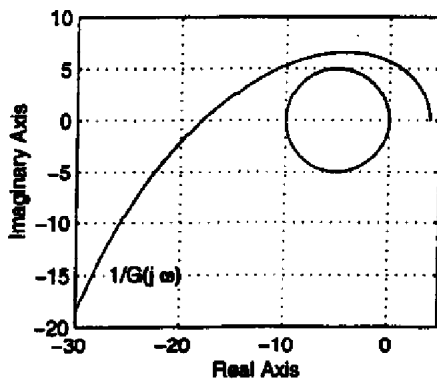

Figure 7.21: Exercise 7.14.

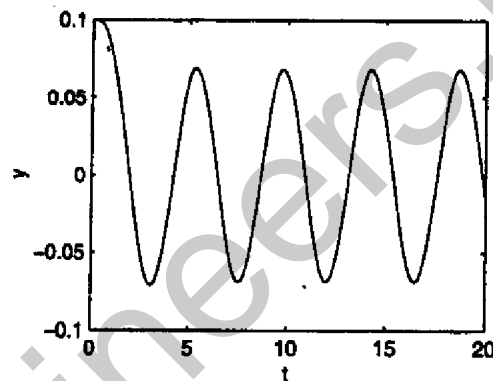

Figure 7.22: Exercise 7.14.

• 7.15 (a) The nonlinearity belongs to the sector  $[0, b]$ . By using Matlab to find the Nyquist plot of  $G(j\omega)$ , we found that  $\min \text{Re}[G(j\omega)] = -1.1638$ . Hence, the origin is globally asymptotically stable for  $b < 1/1.1638 = 0.8593$ .

(b) By using Matlab, we found that the Popov plot intersects the real axis at  $-0.5564$ . With  $\gamma = 1/1.1$  we can draw a line of slope  $1/\gamma$  which passes through the point  $(-0.5564, 0)$  and is to the left of the Popov plot. The choice  $\gamma = 1.1$  satisfies the condition  $1 + \gamma\lambda \neq 0$  since  $\lambda = -1$  or  $-2$ . The condition  $1 + \gamma kCB > 0$  is satisfied for any  $\gamma$  since  $CB = 0$  (the transfer function has relative degree two). Thus, the origin is globally asymptotically stable for  $b < 1/0.5564 = 1.7972$ .

(c)  $\psi$  is a special case of the piecewise linear function of Example 7.7 with  $s_1 = b$ ,  $s_2 = 0$ , and  $\delta = 1/b$ . The describing function is

$$\Psi(a) = \frac{2b}{\pi} \left[ \sin^{-1} \left( \frac{1}{ab} \right) + \frac{1}{ab} \sqrt{1 - \left( \frac{1}{ab} \right)^2} \right]$$

The harmonic balance equation is

$$1 + G(j\omega)\Psi(a) = 0 \Leftrightarrow \frac{1}{G(j\omega)} + \Psi(a) = 0$$

$$\frac{1}{10} [2(1 - 2\omega^2) + j\omega(5 - \omega^2)] + \Psi(a) = 0$$

The imaginary part yields  $\omega^2 = 5$ ; then the real part yields  $\Psi(a) = 1.8$ . Because  $\psi(a)$  starts from  $b$  at  $a = 0$  and decreases after  $a = 1/b$ , the equation  $\psi(a) = 1.8$  has a solution if  $b > 1.8$ . Thus, the describing function method predicts that there will oscillation for  $b > 1.8$ . The frequency of oscillation will be close to  $\omega = \sqrt{5} = 2.2361$ .

《非线性系统（第三版）》习题解答

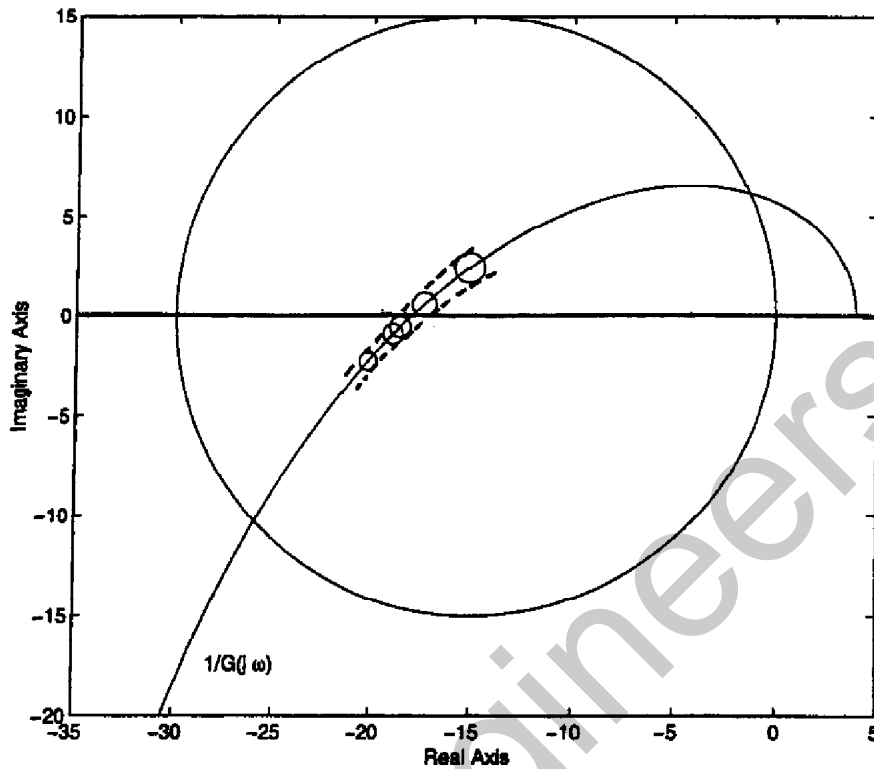

Figure 7.23: Exercise 7.14.

• 7.16 (a)

$$G(j\omega) = \frac{(1 - 3\omega^2) + j\omega(\omega^2 - 3)}{(1 + \omega^2)^3}$$

$$\text{Im } G(j\omega) = 0 \Rightarrow \omega = \sqrt{3}$$

$$\text{Re } G(j\sqrt{3}) = -\frac{1}{8} \Rightarrow \Psi(a) = 8$$

With  $s_1 = 10$ ,  $s_2 = 0$  and  $\delta = 0.1$ , the describing function is given by

$$\Psi(a) = \frac{2\theta}{\pi} \left[ \sin^{-1} \left( \frac{1}{10a} \right) + \frac{1}{10a} \sqrt{1 - \left( \frac{1}{10a} \right)^2} \right]$$

Plotting  $\psi(a)$  using Matlab, we determined that  $\Psi(a) = 8$  corresponds to  $a = 0.146$ . Thus we predict that there is an oscillation of frequency close to  $\sqrt{3}$  rad/s and amplitude of the first harmonic close to 0.146.

(b)

$$\frac{1}{G(j\omega)} = 1 - 3\omega^2 + j\omega(3 - \omega^2)$$

The inverse Nyquist plot is shown in Figure 7.24, together with the critical circle and the band of uncertainty. It defines a complete intersection with  $\omega_1 = 1.699$ ,  $\omega_2 = 1.76$ ,  $a_1 = 0.139$ , and  $a_2 = 0.1535$ . Thus, by Theorem 7.4 we conclude that there is an oscillation of frequency  $\omega \in (1.699, 1.76)$  and amplitude of the first harmonic  $a \in (0.139, 0.1535)$ .

(c) Figure 7.25 shows the inverse Nyquist plot with three critical circle corresponding to  $k = 4, 7.5, 10$ . With

## 《非线性系统（第三版）》习题解答

$k = 4$ , the inverse Nyquist plot lies outside the critical circle. It follows from the first part of Theorem 7.4 that there is no oscillation. This however is a conservative estimate because we can use the second part of the theorem to conclude that there is no oscillation if the inverse Nyquist plot enters the critical circle but for each point inside the critical circle the error circle does not intersect the real axis. The critical circle with  $k = 7.5$  captures this situation. Therefore, we conclude that the largest slope for which the system does not oscillate is about 7.5.

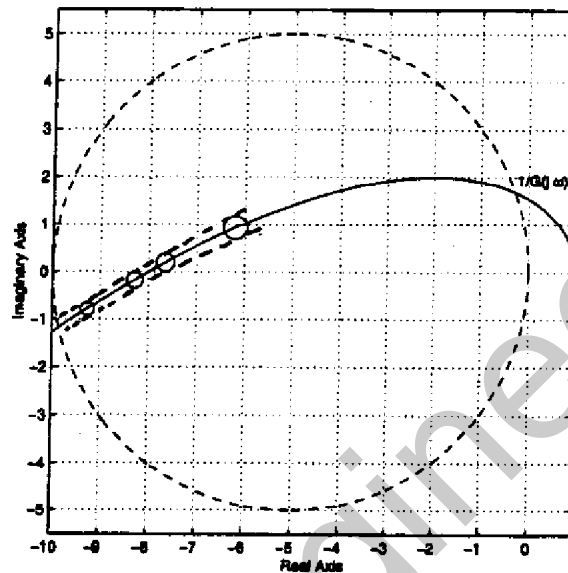

Figure 7.24: Exercise 7.16.

• 7.17 (1)

$$G(j\omega) = \frac{2(j\omega - 1)}{(j\omega)^3(j\omega + 1)} = \frac{-2j(1 - j\omega)^2}{\omega^3(1 + \omega^2)} = \frac{-4\omega - 2j(1 - \omega^2)}{\omega^3(1 + \omega^2)}$$

$$\text{Im}[G(j\omega)] = 0 \Rightarrow \omega = 1$$

$\text{Re}[G(j)] = -2$  and the equation  $1 + \Psi(a)\text{Re}[G] = 0$  yields  $\Psi(a) = \frac{1}{2}$ . The describing function of the saturation nonlinearity is given in Example 7.7. The equation  $\Psi(a) = \frac{1}{2}$  has a unique solution  $a = 2.47$ . Thus, we expect the system to have a periodic solution with amplitude close to 2.47 and frequency close to 1 rad/sec. To confirm this conjecture, we apply Theorem 7.4. The uncertainty band defines a complete intersection. The sketch in Figure 7.26 shows the details of the complete intersection. The two circles (almost) tangent to the real axis have  $\omega_1 = 0.948$ ,  $\Psi(a_1) = 0.4255$  and  $\omega_2 = 1.032$ ,  $\Psi(a_2) = 0.5494$ . From the describing function of the saturation nonlinearity, we find that  $\Psi(a) = 0.4255$  gives  $a = 2.933$  and  $\Psi(a) = 0.5494$  gives  $a = 2.238$ . Thus, Theorem 7.4 confirms that there is a half-wave symmetric periodic solution with frequency in the range  $[0.948, 1.032]$  and the amplitude of the first harmonic is in the range  $[2.238, 2.933]$ .

(2) From Example 7.14, we know that the harmonic balance equation has a solution with  $\omega = 2\sqrt{2}$  and  $\Psi(a) = 0.8$ . The inverse Nyquist plot is shown in Figure 7.21 of the text. For the nonlinearity  $\psi(y) = \frac{1}{2} \sin y$ , the slope restriction is satisfied with  $\alpha = -\frac{1}{2}$  and  $\beta = \frac{1}{2}$ . Therefore, the critical circle is centered at the origin and has a radius of 0.5. Neither the inverse Nyquist plot nor the uncertainty band enter the critical circle. Hence, by the first part of Theorem 7.4, we conclude that there is no oscillation.

(3) From Example 7.14, we know that the harmonic balance equation has a solution with  $\omega = 2\sqrt{2}$  and  $\Psi(a) = 0.8$ . The inverse Nyquist plot is shown in Figure 7.21 of the text. The nonlinearity satisfies the slope restriction with  $\alpha = -1$  and  $\beta = 1$ . Therefore, the critical circle is centered at the origin and has a radius

《非线性系统（第三版）》习题解答

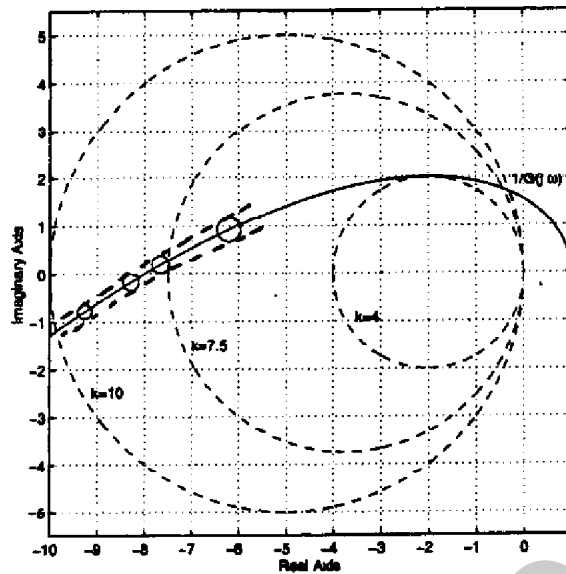

Figure 7.25: Exercise 7.16.

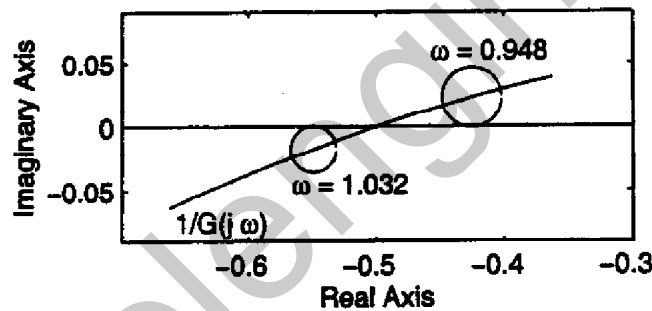

Figure 7.26: Exercise 7.17(1).

of 1. The describing function is given by

$$\Psi(a) = \begin{cases} 1 & 0 \leq a \leq 2 \\ \left(\frac{4}{\pi}\right) \sin^{-1}\left(\frac{2}{a}\right) + \frac{8}{\pi a} \sqrt{1 - (2/a)^2} - 1 & 2 \leq a \leq 3 \\ \frac{4}{\pi} \left[ \sin^{-1}\left(\frac{2}{a}\right) - \sin^{-1}\left(\frac{3}{a}\right) \right] + \frac{8}{\pi a} \sqrt{1 - (2/a)^2} - \frac{12}{\pi a} \sqrt{1 - (3/a)^2} + 1 & a \geq 3 \end{cases}$$

It is shown in Figure 7.27. The equation  $\Psi(a) = 0.8$  has two roots at  $a = 2.48$  and  $a = 12.47$ . Thus, we expect that there are two periodic solutions, one with amplitude close to 2.48 and frequency close to  $2\sqrt{2}$  rad/sec. and the other with amplitude close to 12.47 and frequency close to  $2\sqrt{2}$  rad/sec. Next, we apply Theorem 7.4. It is clear from Figure 7.27 that  $\Psi'(a)$  is different than zero at the roots  $a_*$ . Thus, all the conditions of Theorem 7.4 (case 3) are satisfied and we confirm the existence of the periodic solutions. By calculating and plotting the uncertainty band, it can be seen that the boundaries of the band intersect the real axis at  $-0.6481$  and  $-0.9519$ . The frequencies of the error circles closest to the real axis are  $\omega = 1.75$

## 《非线性系统（第三版）》习题解答

and  $\omega = 2.905$ . Using the graph of  $\Psi(a)$ , the set  $\Gamma$  corresponding to each solution is given by

$$\Gamma_1 = \{(\omega, a) \mid 2.75 \leq \omega \leq 2.905, 2.1606 \leq a \leq 2.803\}$$

$$\Gamma_2 = \{(\omega, a) \mid 2.75 \leq \omega \leq 2.905, 6.7065 \leq a \leq 52.8815\}$$

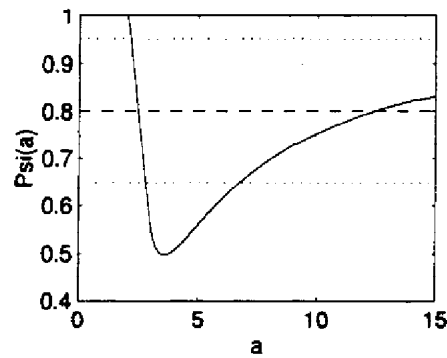

Figure 7.27: Exercise 10.42.

(4) The harmonic balance equation has the solution  $\omega = \sqrt{3}$  and  $\Psi(a) = 1$ . For the given nonlinearity,  $\Psi(a) = 1$  yields the unique solution  $a = 0.8165$ . Application of Theorem 7.4 succeeds and gives

$$\Gamma = \{(\omega, a) \mid 1.711 \leq \omega \leq 1.749, 0.7746 \leq a \leq 0.8485\}$$



## 《非线性系统（第三版）》习题解答

### Chapter 8

- 8.1 As in the proof of Theorem 8.1, take  $v(y, w) = V(y) + \sqrt{w^T P w}$ . Then

$$\dot{v} \leq \frac{\partial V}{\partial y} [A_1 y + g_1(y, h(y))] - \frac{1}{4\sqrt{\lambda_{\max}(P)}} \|w\|_2 \leq 0$$

Hence, the origin is stable.

- 8.2 From Theorem 8.2, we know that asymptotic stability of the origin of the reduced system implies asymptotic stability of the origin of the full system. The opposite statement can be proved by contradiction. Suppose the origin of the full system is asymptotically stable but the origin of the reduced system is not so. Asymptotic stability of the origin of the full system implies its stability, which in turn implies stability of the origin of the reduced system. If the origin of the reduced system is stable but not asymptotically stable, then there is a bounded solution  $y(t)$  (with  $\|y(0)\|$  arbitrarily small) which does not converge to zero as  $t$  tends to infinity. Then, the corresponding solution  $(y(t), 0)$  of the full system does not converge to zero, which contradicts asymptotic stability of the origin of the full system.

- 8.3 If  $g_2(y, 0) = 0$ , then  $h(y) = 0$  satisfies the PDE (8.8). If  $g_1(y, 0) = 0$  and  $A_1 = 0$ , the reduced system is  $\dot{y} = 0$ . The origin of the reduced system is stable and the Lyapunov function  $V(y) = y^T y$  satisfies the condition of Corollary 8.1. Thus, the origin of the full system is stable.

- 8.4 In Example 8.1,  $A_1 = 0$  and  $a = 0$  yields  $g_1(y, z) = -b(yz + z^2)$  and  $g_2(y, z) = b(yz + z^2)$ . Thus,  $g_1(y, 0) = g_2(y, 0) = 0$  and the conclusion follows from the previous exercise.

- 8.5

(a) The function  $f_b(x_a, x_b)$  can be expanded as

$$f_b(x_a, x_b) = \frac{\partial f_b}{\partial x_a}(0, 0)x_a + \frac{\partial f_b}{\partial x_b}(0, 0)x_b + \tilde{f}_b(x_a, x_b) = \frac{\partial f_b}{\partial x_a}(0, 0)x_a + \tilde{f}_b(x_a, x_b)$$

where  $\tilde{f}_b(x_a, x_b)$  vanishes at  $(0, 0)$  together with its first partial derivatives. Since  $f_b(x_a, 0) = 0$  in the neighborhood of  $x_a = 0$ ,  $\frac{\partial f_b}{\partial x_a}(0, 0) = 0$ . Let  $x = \begin{bmatrix} x_a \\ x_b \end{bmatrix}$  and  $f(x) = \begin{bmatrix} f_a(x_a, x_b) \\ A_b x_b + f_b(x_a, x_b) \end{bmatrix}$ . Then

$$\frac{\partial f}{\partial x}(0) = \begin{bmatrix} \frac{\partial f_a}{\partial x_a}(0, 0) & \frac{\partial f_a}{\partial x_b}(0, 0) \\ \frac{\partial f_b}{\partial x_a}(0, 0) & A_b + \frac{\partial f_b}{\partial x_b}(0, 0) \end{bmatrix} = \begin{bmatrix} \frac{\partial f_a}{\partial x_a}(0, 0) & \frac{\partial f_a}{\partial x_b}(0, 0) \\ 0 & A_b \end{bmatrix}$$

If the origin of  $\dot{x}_a = f_a(x_a, 0)$  is exponentially stable, then (from the Theorem 4.15) the matrix  $\frac{\partial f_a}{\partial x_a}(0, 0)$  is Hurwitz. Consequently, the matrix  $\frac{\partial f}{\partial x}(0)$  is Hurwitz and the origin  $x = 0$  is an exponentially stable equilibrium point of the full system.

## 《非线性系统（第三版）》习题解答

(b) In this case, the matrix  $\frac{\partial f}{\partial x_a}(0, 0)$  has some eigenvalues with zero real parts, with the remaining eigenvalues (if any) having negative real parts. By a linear change of coordinates, the full system can be transformed into the form

$$\begin{aligned}\dot{\eta}_1 &= F_1 \eta_1 + q_1(\eta_1, \eta_2, x_b) \\ \dot{\eta}_2 &= F_2 \eta_2 + G_2 x_b + q_2(\eta_1, \eta_2, x_b) \\ \dot{x}_b &= A_b x_b + f_b(\eta_1, \eta_2, x_b)\end{aligned}$$

with  $F_2$  having all eigenvalues with negative real parts and  $F_1$  having all eigenvalues with zero real parts. Moreover, the functions  $q_1$  and  $q_2$  vanish at  $(0, 0, 0)$  together with their first partial derivatives. By assumption, the origin  $(\eta_1, \eta_2) = (0, 0)$  is an asymptotically stable equilibrium point of the system

$$\dot{\eta}_1 = F_1 \eta_1 + q_1(\eta_1, \eta_2, 0), \quad \dot{\eta}_2 = F_2 \eta_2 + q_2(\eta_1, \eta_2, 0)$$

Let  $\eta_2 = \pi_2(\eta_1)$  be a center manifold for this system. Then,  $\pi_2$  satisfies the PDE

$$\frac{\partial \pi_2}{\partial \eta_1} [F_1 \eta_1 + q_1(\eta_1, \pi_2(\eta_1), 0)] = F_2 \pi_2(\eta_1) + q_2(\eta_1, \pi_2(\eta_1), 0)$$

From Corollary 8.2, we conclude that the origin  $\eta_1 = 0$  is an asymptotically stable equilibrium point of the reduced system

$$\dot{\eta}_1 = F_1 \eta_1 + q_1(\eta_1, \pi_2(\eta_1), 0)$$

Consider now the full system. The center manifold for the full system is the pair

$$\eta_2 = h_2(\eta_1), \quad x_b = h_1(\eta_1)$$

that satisfies the PDE's

$$\frac{\partial h_2}{\partial \eta_1} [F_1 \eta_1 + q_1(\eta_1, h_2(\eta_1), h_1(\eta_1))] = F_2 h_2(\eta_1) + G_2 h_1(\eta_1) + q_2(\eta_1, h_2(\eta_1), h_1(\eta_1))$$

$$\frac{\partial h_1}{\partial \eta_1} [F_1 \eta_1 + q_1(\eta_1, h_2(\eta_1), h_1(\eta_1))] = A_b h_1(\eta_1) + f_b(\eta_1, h_2(\eta_1), h_1(\eta_1))$$

It can be verified that these equations are solved by  $h_2(\eta_1) = \pi_2(\eta_1)$  and  $h_1(\eta_1) = 0$ . Thus, the reduced system (of the full problem) is

$$\dot{\eta}_1 = F_1 \eta_1 + q_1(\eta_1, \pi_2(\eta_1), 0)$$

Since the origin of this system is asymptotically stable, we conclude from Theorem 8.2 that the origin of the full system is asymptotically stable.

• 8.6 (1)  $A = \frac{\partial f}{\partial x} \Big|_{x=0} = \begin{bmatrix} 0 & 0 \\ 0 & -1 \end{bmatrix}$ . Take  $y = x_1$  and  $z = x_2$ .

$$\dot{y} = -z^2, \quad \dot{z} = -z + y^2 + yz$$

$$N(h(y)) = h'(y)[-h^2(y)] + h(y) - y^2 - yh(y) = 0, \quad h(0) = 0, \quad h'(0) = 0$$

Try  $h(y) = O(|y|^2)$ . It yields the reduced system  $\dot{y} = -y^2 O(|y|^2)$ . We cannot reach any conclusion using this equation. Next, try  $h(y) = h_2 y^2 + O(|y|^3)$ . Substituting this expression in the center manifold equation and matching the coefficients of  $y^2$ , we obtain  $h_2 = 1$ . The reduced system is

$$\dot{y} = -y^4 + O(|y|^5)$$

## 《非线性系统（第三版）》习题解答

The origin of this system is unstable. Hence, the origin of the full system is unstable.

(2)  $A = \left. \frac{\partial f}{\partial x} \right|_{x=0} = \begin{bmatrix} 0 & 0 \\ 0 & -1 \end{bmatrix}$ . Take  $y = x_1$  and  $z = x_2$ .

$$\dot{y} = ay^2 - z^2, \quad \dot{z} = -z + y^2 + yz$$

$$\mathcal{N}(h(y)) = h'(y)[ay^2 - h^2(y)] + h(y) - y^2 - yh(y) = 0, \quad h(0) = 0, \quad h'(0) = 0$$

Try  $h(y) = O(|y|^2)$ . It yields the reduced system

$$\dot{y} = ay^2 + O(|y|^4), \quad a \neq 0$$

The origin of this system is unstable. Hence, the origin of the full system is unstable.

(3)

$$A = \left. \frac{\partial f}{\partial x} \right|_{x=0} = \begin{bmatrix} 0 & -1 & 0 \\ 1 & 0 & 0 \\ 0 & 0 & -1 \end{bmatrix}$$

Take  $y = [x_1 \quad x_2]^T$  and  $z = x_3$ .

$$\dot{y}_1 = -y_2 + y_1 z, \quad \dot{y}_2 = y_1 + y_2 z, \quad \dot{z} = -z - (y_1^2 + y_2^2) + z^2$$

$$\mathcal{N}(h(y)) = \frac{\partial h}{\partial y_1}[-y_2 + y_1 h(y)] + \frac{\partial h}{\partial y_2}[y_1 + y_2 h(y)] + h(y) + y_1^2 + y_2^2 - h^2(y) = 0, \quad h(0) = 0, \quad \frac{\partial h}{\partial y_1}(0) = 0, \quad \frac{\partial h}{\partial y_2}(0) = 0$$

Trying  $h(y) = O(\|y\|^2)$  we reached no conclusion. So we take

$$h(y) = \phi(y) + O(\|y\|^3), \quad \text{where } \phi(y) = y^T P y = p_{11}y_1^2 + 2p_{12}y_1y_2 + p_{22}y_2^2$$

$$\frac{\partial \phi}{\partial y_1} = 2p_{11}y_1 + 2p_{12}y_2, \quad \frac{\partial \phi}{\partial y_2} = 2p_{12}y_1 + 2p_{22}y_2$$

Substituting these expressions in the center manifold equation and matching the coefficients of  $y_1^2$ ,  $y_1y_2$ , and  $y_2^2$ , we obtain

$$p_{11} + 1 + 2p_{12} = 0, \quad -2p_{11} + 2p_{22} + 2p_{12} = 0, \quad -2p_{12} + p_{22} + 1 = 0$$

whose solution is  $p_{11} = p_{22} = -1$  and  $p_{12} = 0$ . Hence we have  $h(y) = -(y_1^2 + y_2^2) + O(\|y\|^3)$  and the reduced system is

$$\dot{y}_1 = -y_2 - y_1(y_1^2 + y_2^2) + O(\|y\|^4), \quad \dot{y}_2 = y_1 - y_2(y_1^2 + y_2^2) + O(\|y\|^4)$$

Try  $V(y) = \frac{1}{2}(y_1^2 + y_2^2)$  as a Lyapunov function candidate.

$$\dot{V}(y) = -(y_1^2 + y_2^2)^2 + O(\|y\|^5)$$

Hence  $\dot{V}(y)$  is negative definite in some neighborhood of the origin and the origin is asymptotically stable. Thus, the origin of the full system is asymptotically stable.

(4)  $A = \left. \frac{\partial f}{\partial x} \right|_{x=0} = \begin{bmatrix} 0 & 0 \\ 0 & -1 \end{bmatrix}$ . Take  $y = x_1$  and  $z = x_2$ .

$$\dot{y} = y^2 z, \quad \dot{z} = -z - y^3$$

$$\mathcal{N}(h(y)) = -h'(y)y^2 h(y) - h(y) - y^3 = 0, \quad h(0) = 0, \quad h'(0) = 0$$

Try  $h(y) = O(|y|^2)$ . It yields the reduced system  $\dot{y} = y^2 O(|y|^2)$ . We cannot reach any conclusion using this equation. Next, try  $h(y) = h_2 y^2 + O(|y|^3)$ . Substituting this expression in the center manifold equation and matching the coefficients of  $y^2$ , we obtain  $h_2 = 0$ . Try  $h(y) = h_3 y^3 + O(|y|^4)$ . Substituting this expression

## 《非线性系统（第三版）》习题解答

in the center manifold equation and matching the coefficients of  $y^3$ , we obtain  $h_3 = -1$ . The origin of the reduced system

$$\dot{y} = -y^5 + O(|y|^6)$$

is asymptotically stable. Hence, the origin of the full system is asymptotically stable.

(5)  $A = \frac{\partial f}{\partial x} \Big|_{x=0} = \begin{bmatrix} 0 & 0 \\ 0 & -1 \end{bmatrix}$ . Take  $y = x_1$  and  $z = x_2$ .

$$\dot{y} = yz^3, \quad \dot{z} = -z - y^2 + 2y^8$$

$$\mathcal{N}(h(y)) = h'(y)[yh^3(y)] + h(y) + y^2 - 2y^8 = 0, \quad h(0) = 0, \quad h'(0) = 0$$

It can be seen that  $h(y) = -y^2$  satisfies this PDE. The origin of the reduced system  $\dot{y} = -y^7$  is asymptotically stable. Hence, the origin of the full system is asymptotically stable.

(6)  $A = \frac{\partial f}{\partial x} \Big|_{x=0} = \begin{bmatrix} -1 & 0 \\ 0 & 0 \end{bmatrix}$ . Take  $y = x_2$  and  $z = x_1$ .

$$\dot{y} = y^3(z + y - 1), \quad \dot{z} = -z - y^2 + y^3(z + y - 1)$$

$$\mathcal{N}(h(y)) = h'(y)[y^3(h(y) + y - 1)] + h(y) - y^3(h(y) + y - 1) = 0, \quad h(0) = 0, \quad h'(0) = 0$$

Try  $\phi(y) = 0$ . Then  $h(y) = O(|y|^3)$  and the reduced system is  $\dot{y} = -y^3 + O(|y|^4)$ . The origin of this system is asymptotically stable. Hence, the origin of the full system is asymptotically stable.

(7)  $A = \frac{\partial f}{\partial x} \Big|_{x=0} = \begin{bmatrix} 0 & 1 \\ 0 & -1 \end{bmatrix}$ . Take  $y = x_1 + x_2$  and  $z = x_2$ .

$$\dot{y} = a \frac{(y-z)^3}{1+(y-z)^2}, \quad \dot{z} = -z + a \frac{(y-z)^3}{1+(y-z)^2}$$

$$\mathcal{N}(h(y)) = h'(y) \left[ a \frac{(y-h(y))^3}{1+(y-h(y))^2} \right] + h(y) - a \frac{(y-h(y))^3}{1+(y-h(y))^2} = 0, \quad h(0) = 0, \quad h'(0) = 0$$

Try  $\phi(y) = 0$ . Then  $h(y) = O(|y|^3)$  and the reduced system is

$$\dot{y} = a \frac{y^3}{1+y^2} + O(|y|^4) = ay^3 + O(|y|^4)$$

The origin of the full system is asymptotically stable if  $a < 0$  and unstable if  $a > 0$ .

(8)

$$A = \frac{\partial f}{\partial x} \Big|_{x=0} = \begin{bmatrix} -2 & -3 & 1 \\ 1 & 1 & 0 \\ 0 & 0 & 0 \end{bmatrix}$$

Take  $y = x_3$  and  $z = \begin{bmatrix} x_1 + x_3 \\ x_2 - x_3 \end{bmatrix}$ .

$$\dot{y} = (z_1 - y)^2, \quad \dot{z}_1 = -2z_1 - 3z_2 + y^2 + (z_1 - y)^2, \quad \dot{z}_2 = z_1 + z_2$$

$$\mathcal{N}_1(h(y)) = h'_1(y)[h_1(y) - y]^2 + 2h_1(y) + 3h_2(y) - y^2 - [h_1(y) - y]^2$$

$$\mathcal{N}_2(h(y)) = h'_2(y)[h_1(y) - y]^2 - h_1(y) - h_2(y)$$

$$h_i(0) = 0, \quad h'_i(0) = 0, \quad i = 1, 2$$

Try  $\phi(y) = 0$ .

$$\mathcal{N}_1(0) = O(|y|^2), \quad \mathcal{N}_2(0) = 0$$

The origin of the reduced system  $\dot{y} = y^2 + O(|y|^3)$  is unstable. Hence, the origin of the full system is unstable.

## 《非线性系统（第三版）》习题解答

• 8.7  $A = \frac{\partial f}{\partial x} \Big|_{x=0} = \begin{bmatrix} 0 & 0 \\ 0 & -1 \end{bmatrix}$ . Take  $y = x_1$  and  $z = x_2$ .

$$\dot{y} = yz + ay^3 + byz^2, \quad \dot{z} = -z + cy^2 + dy^2z$$

$$\mathcal{N}(h(y)) = h'(y)[yh(y) + ay^3 + byh^2(y)] + h(y) - cy^2 - dy^2h(y) = 0, \quad h(0) = 0, \quad h'(0) = 0$$

We reach no conclusion by trying  $h(y) = O(|y|^2)$ . So we take  $h(y) = h_2y^2 + O(|y|^3)$ . Substitution in the center manifold equation and matching of the coefficients of  $y^2$  yield  $h_2 = c$ . The reduced system is

$$\dot{y} = (a + c)y^3 + O(|y|^4)$$

$a + c > 0 \Rightarrow$  The origin is unstable

$a + c < 0 \Rightarrow$  The origin is asymptotically stable

When  $a + c = 0$  we can reach no conclusion. we seek a higher-order approximation of  $h(y)$ . We take  $h(y) = cy^2 + h_3y^3 + O(|y|^4)$ . Substitution in the center manifold equation and matching of the coefficients of  $y^3$  yield  $h_3 = 0$ . So we take  $h(y) = cy^2 + h_4y^4 + O(|y|^5)$  and repeat the process to obtain  $h_4 = cd$  by matching the coefficients of  $y^4$ . The reduced system is

$$\dot{y} = (a + c)y^3 + (cd + bc^2)y^5 + O(|y|^6) = (cd + bc^2)y^5 + O(|y|^6)$$

since  $a + c = 0$ .

$a + c = 0$  and  $cd + bc^2 > 0 \Rightarrow$  The origin is unstable

$a + c = 0$  and  $cd + bc^2 < 0 \Rightarrow$  The origin is asymptotically stable

If  $a + c = cd + bc^2 = 0$ , we cannot reach a conclusion and we seek a higher-order approximation of  $h$ . Proceeding as before, we obtain

$$h(y) = cy^2 + cdy^4 + cd^2y^6 + O(|y|^7)$$

The reduced system is

$$\dot{y} = (a + c)y^3 + (cd + bc^2)y^5 + (cd^2 + 2bc^2d)y^7 + O(|y|^8) = -cd^2y^7 + O(|y|^8)$$

$a + c = cd + bc^2 = 0$  and  $cd^2 < 0 \Rightarrow$  The origin is unstable

$a + c = cd + bc^2 = 0$  and  $cd^2 > 0 \Rightarrow$  The origin is asymptotically stable

The only case left is  $a + c = cd + bc^2 = cd^2 = 0$ . If  $c = 0$ , we have  $a = 0$  and  $h(y) = 0$  solves the center manifold equation exactly, resulting in the reduced system  $\dot{y} = 0$ . If  $c \neq 0$ , we must have  $b = d = 0$  and  $h(y) = cy^2$  solves the center manifold equation exactly, resulting in the reduced system  $\dot{y} = 0$ . In either case, the conditions of Corollary 8.1 are satisfied; hence, the origin of the full system is stable.

• 8.8  $A = \frac{\partial f}{\partial x} \Big|_{x=0} = \begin{bmatrix} 0 & 0 \\ 0 & -1 \end{bmatrix}$ . Take  $y = x_1$  and  $z = x_2$ .

$$\dot{y} = ay^3 + y^2z, \quad \dot{z} = -z + z^2 + zy - y^3$$

$$\mathcal{N}(h(y)) = h'(y)[ay^3 + y^2h(y)] + h(y) - h^2(y) - yh(y) + y^3 = 0, \quad h(0) = h'(0) = 0$$

Try  $h(y) = O(|y|^2)$ . The reduced system is

$$\dot{y} = ay^3 + O(|y|^4)$$

$a > 0 \Rightarrow$  The origin is unstable

## 《非线性系统（第三版）》习题解答

$a < 0 \Rightarrow$  The origin is asymptotically stable

If  $a = 0$ , we reach no conclusion. We take  $h(y) = h_2 y^2 + O(|y|^3)$ . Substituting  $h(y)$  in the center manifold equation and matching the coefficients of  $y^3$ , we obtain  $h_2 = 0$ . We take  $h(y) = h_3 y^3 + O(|y|^4)$  and repeat the process to obtain  $h_3 = -1$ . The reduced system is

$$\dot{y} = ay^3 - y^5 + O(|y|^6) = -y^5 + O(|y|^6)$$

The origin is asymptotically stable.

• 8.9  $A = \left. \frac{\partial f}{\partial x} \right|_{x=0} = \begin{bmatrix} 0 & 0 \\ 0 & -1 \end{bmatrix}$ . Take  $y = x_1$  and  $z = x_2$ .

$$\dot{y} = ayz - y^3, \quad \dot{z} = -z + byz + cy^2$$

$$\mathcal{N}(h(y)) = h'(y)[ayh(y) - y^3] + h(y) - byh(y) - cy^2 = 0, \quad h(0) = 0, \quad h'(0) = 0$$

We reach no conclusion by trying  $h(y) = O(|y|^2)$ . So we take  $h(y) = h_2 y^2 + O(|y|^3)$ . Substitution in the center manifold equation and matching of the coefficients of  $y^2$  yield  $h_2 = c$ . The reduced system is

$$\dot{y} = (ac - 1)y^3 + O(|y|^4)$$

$ac - 1 > 0 \Rightarrow$  The origin is unstable

$ac - 1 < 0 \Rightarrow$  The origin is asymptotically stable

When  $ac - 1 = 0$  we cannot reach a conclusion. We seek a higher-order approximation of  $h(y)$ . We take  $h(y) = cy^2 + h_3 y^3 + O(|y|^4)$ . Substitution in the center manifold equation and matching of the coefficients of  $y^3$  yield  $h_3 = bc$ . The reduced system is

$$\dot{y} = (ac - 1)y^3 + bacy^4 + O(|y|^5) = by^4 + O(|y|^5)$$

If  $b \neq 0$ , the origin is unstable. The only case left is the case  $ac = 1$  and  $b = 0$ . In this case, the center manifold equation is solved exactly by  $h(y) = cy^2$ . The reduced system is  $\dot{y} = 0$ . Its origin is stable and the Lyapunov function  $V(y) = y^2$  satisfies the condition of Corollary 8.1. Hence, the origin of the full system is stable.

• 8.10 In the neighborhood of the origin,  $V(x)$  is positive definite and  $\dot{V}(x)$  is negative definite. Hence, the origin is asymptotically stable. To show that  $G$  is exactly the region of attraction, we need to show that

$$x(0) \in G \Rightarrow x(t) \rightarrow 0 \text{ as } t \rightarrow \infty \text{ and } x(0) \notin G \Rightarrow x(t) \not\rightarrow 0 \text{ as } t \rightarrow \infty$$

Let  $x(0) \in G$ . Then  $V(x(0)) < 1$ . Choose  $c > 0$  such that  $V(x(0)) \leq c < 1$ . Consider the set  $\Omega = \{x \in G \mid V(x) \leq c\}$ .  $\Omega$  is in the interior of  $G$ . Moreover,  $\Omega$  is bounded since  $\lim_{\|x\| \rightarrow \infty} V(x) = 1$  and  $c < 1$ .  $\Omega$  is positively invariant since  $\dot{V}(x)$  is negative definite. For  $x \in G$ , we have

$$\dot{V}(x) = 0 \Rightarrow h(x)[1 - V(x)] = 0 \Rightarrow h(x) = 0 \Rightarrow x = 0$$

where we have used the fact that  $1 - V(x) > 0$  for all  $x \in G$ . Thus, by LaSalle's theorem,  $x(t) \rightarrow 0$  as  $t \rightarrow \infty$ . Now, let  $x(0) \notin G$  and suppose  $x(t) \rightarrow 0$  as  $t \rightarrow \infty$ . Then  $x(t)$  must enter the set  $G$ . Hence, there are finite times  $t_1$  and  $t_2 > t_1$  such that  $x(t_1) \in \partial G$  and  $x(t) \in G$  for all  $t \in (t_1, t_2]$ . Let  $W(x) = 1 - V(x)$ .

$$\dot{W}(x) = -\dot{V}(x) = h(x)(1 - V(x)) = h(x)W(x)$$

## 《非线性系统（第三版）》习题解答

$$\begin{aligned}
 \int_{W_0}^W \frac{dW}{W} &= \int_{t_0}^t h(x(s)) ds \\
 W(x(t)) &= W(x(t_0)) e^{\int_{t_0}^t h(x(s)) ds} \\
 1 - V(x(t_0)) &= [1 - V(x(t))] e^{-\int_{t_0}^t h(x(s)) ds}
 \end{aligned}$$

Take  $t = t_2$  and let  $t_0 \rightarrow t_1$ .

$$\lim_{t_0 \rightarrow t_1} L.H.S. = \lim_{t_0 \rightarrow t_1} [1 - V(x(t_0))] = 0 \quad \text{and} \quad \lim_{t_0 \rightarrow t_1} R.H.S. > 0 \quad \text{Contradiction}$$

Thus if  $x(0) \notin G$ ,  $x(t) \not\rightarrow 0$ .

• 8.11 Let

$$G = \{x \in \mathbb{R}^2 \mid -a_i < x_i < b_i\}$$

Using the hint, (8.17) takes the form

$$\left( \frac{\partial W_1}{\partial x_1} + g_1(x_1)W_1(x_1) \right) W_2(x_2)h(x_1) + \left( \frac{\partial W_2}{\partial x_2} W_1(x_1)g_1(x_1) - \frac{\partial W_1}{\partial x_1} W_2(x_2)g_2(x_2) \right) = 0$$

The equation is satisfied by  $W_1$  and  $W_2$  which satisfy

$$\frac{\partial W_1}{\partial x_1} = -g_1(x_1)W_1(x_1), \quad \text{and} \quad \frac{\partial W_2}{\partial x_2} = -g_2(x_2)W_2(x_2)$$

Thus, equation (8.17) is satisfied with

$$V(x) = 1 - \exp \left( - \int_0^{x_1} g_1(\sigma) d\sigma - \int_0^{x_2} g_2(\sigma) d\sigma \right)$$

The function  $V(x)$  has the properties:  $V(0) = 0$ ,  $0 < V(x) < 1$  for all  $x \in G$ ,  $V(x) \rightarrow 1$  as  $x \rightarrow \partial G$ .

$$\dot{V}(x) = -g_1(x_1)h(x_1)[1 - V(x)] \leq 0$$

All the conditions of Zubov's theorem are satisfied except that  $\dot{V}(x)$  is only negative semidefinite.

$$\dot{V} = 0 \Rightarrow g_1(x_1)h(x_1) = 0 \Rightarrow x_1 = 0$$

$$x_1(t) \equiv 0 \Rightarrow g_2(x_2(t)) \equiv 0 \Rightarrow x_2(t) \equiv 0$$

Hence, by application of LaSalle's theorem (to the set  $\bar{G}$ ) and Zubov's theorem, we conclude that  $G$  is the region of attraction.

• 8.12 The system is a special case of the one treated in the previous exercise with  $h_1(x_1) = x_1$ ,  $g_1(x_1) = \tan x_1$ , and  $g_2(x_2) = x_2$ . It can be verified that all the conditions of the previous exercise are satisfied in the set  $G = \{x \in \mathbb{R}^2 \mid |x_1| < \frac{\pi}{2}\}$ . It follows from the previous exercise that  $G$  is the region of attraction.

• 8.13 Since  $\Omega$  is positively invariant and every trajectory in  $\Omega$  approaches the origin as  $t \rightarrow \infty$ , every point in  $\Omega$  is connected to the origin by an arc. Consequently, any two points in  $\Omega$  are connected by an arc that is formed by connecting the two arcs that connect them to the origin. This shows that  $\Omega$  is connected.

• 8.14 Let  $c = \min_{x \in \partial D} V(x)$ . Then  $\Omega_c = \{V(x) < c\}$  is an estimate of the region of attraction. We have

$$\min_{x_2=1, 0 \leq x_1 \leq 2} \{x_1^2 + x_2^2\} = 1, \quad \min_{x_2=-1, -2 \leq x_1 \leq 0} \{x_1^2 + x_2^2\} = 1$$

$$\min_{x_1-x_2=1, 0 \leq x_1 \leq 2} \{x_1^2 + x_2^2\} = \min_{0 \leq x_1 \leq 2} \{x_1^2 + (x_1 - 1)^2\} = \frac{1}{2}$$

and

$$\min_{x_1-x_2=-1, -2 \leq x_1 \leq 0} \{x_1^2 + x_2^2\} = \min_{-2 \leq x_1 \leq 0} \{x_1^2 + (x_1 + 1)^2\} = \frac{1}{2}$$

Hence  $c = \frac{1}{2}$  and the region of attraction is estimated by  $\{x \in \mathbb{R}^2 \mid x_1^2 + x_2^2 < \frac{1}{2}\}$ .

## 《非线性系统（第三版）》习题解答

• 8.15

(a) Using  $V(x) = 5x_1^2 + 2x_1x_2 + 2x_2^2$ , we have

$$\begin{aligned}\dot{V}(x) &= (10x_1 + 2x_2)x_2 + (2x_1 + 4x_2)[-x_1 - x_2 - (2x_2 + x_1)(1 - x_2^2)] \\ &= -2x_1^2 + 4x_1x_2 - 2x_2^2 - 2(x_1 + 2x_2)^2(1 - x_2^2)\end{aligned}$$

For  $|x_2| \leq 1$ , we have

$$\dot{V}(x) \leq -2(x_1^2 - 2x_1x_2 + x_2^2) = -2(x_1 - x_2)^2 \leq 0$$

$$\dot{V}(x) = 0 \Rightarrow x_1(t) - x_2(t) \equiv 0 \Rightarrow \dot{x}_1(t) - \dot{x}_2(t) \equiv 0 \Rightarrow 3x_2(t)(2 - x_2^2(t)) \equiv 0 \Rightarrow x_2(t) \equiv 0$$

Hence, by LaSalle's Theorem (Corollary 4.1), we conclude that the origin is asymptotically stable.

(b) Notice that  $\dot{V}(x) \leq 0$  for all  $x \in S$ . To show that  $S$  is an estimate of the region of attraction we need to show that  $S$  is positively invariant. The boundary of  $S$  consists of four pieces, as shown in Figure 8.1. The boundaries  $BC$  and  $DA$  are parts of the Lyapunov surface  $V(x) = 5$ . Since  $\dot{V}(x) \leq 0$ , the trajectories cannot leave  $S$  through  $BC$  or  $DA$ . To show a similar property for the boundaries  $AB$  and  $CD$ , notice that

$$\frac{d}{dt}x_2^2 = 2x_2\dot{x}_2 = -2x_2(x_1 + x_2) - 2x_2(x_1 + 2x_2)(1 - x_2^2), \quad \left. \frac{d}{dt}x_2^2 \right|_{|x_2|=1} = -2x_2(x_1 + x_2)$$

It can be easily seen that the right-hand side is nonpositive on the boundaries  $AB$  and  $CD$ . Thus, the trajectories cannot leave  $S$  through  $AB$  or  $CD$ . Hence,  $S$  is positively invariant. It is also compact and  $\dot{V}(x) \leq 0$  in  $S$ . Thus, by LaSalle's theorem, all trajectories starting in  $S$  must approach the largest invariant set in  $\{x \in S \mid \dot{V}(x) = 0\}$ . It is clear from part (a) that the largest invariant set is the origin. Hence,  $S$  is an estimate of the region of attraction.

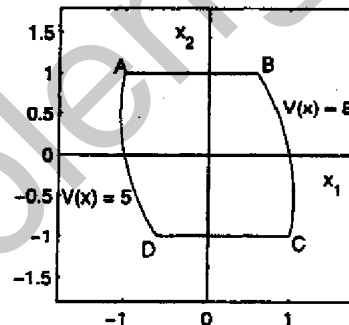

Figure 8.1: Exercise 8.15.

• 8.16

$$\dot{x}_1 = x_2, \quad \dot{x}_2 = -x_2 - (x_1 - x_1^3)$$

Consider the Lyapunov function candidate

$$V(x) = \frac{1}{2}x_2^2 + \int_0^{x_1} (y - y^3) dy = \frac{1}{2}x_2^2 + \frac{1}{2}x_1^2 - \frac{1}{4}x_1^4$$

$V(x)$  is positive definite in the region  $|x_1| < \sqrt{2}$ .

$$\dot{V}(x) = (x_1 - x_1^3)x_2 + x_2[-x_2 - (x_1 - x_1^3)] = -x_2^2$$



## 《非线性系统（第三版）》习题解答

Moreover

$$\dot{V}(x) = 0 \Rightarrow x_2(t) \equiv 0 \Rightarrow x_1(t) - x_1^3(t) \equiv 0 \Rightarrow x_1(t) \text{ for } |x_1| < 1$$

Hence, all the conditions of Corollary 4.1 are satisfied in the domain  $D = \{|x_1| < 1\}$ . We conclude that the origin is asymptotically stable and  $\Omega_c = \{x \in \mathbb{R}^2 \mid V(x) \leq c\}$  is an estimate of the region of attraction, provided  $c$  is chosen small enough to ensure that  $\Omega_c$  is compact and  $\Omega_c \subset D$ . The condition  $\Omega_c \subset D$  is satisfied by choosing  $c < \frac{1}{4}$ . For any  $0 < c < \frac{1}{4}$ , the surface  $V(x) = c$  is closed. Hence,  $\Omega_c$  with  $0 < c < \frac{1}{4}$  is an estimate of the region of attraction. Equivalently, we can estimate the region of attraction by the open set  $\{x \in \mathbb{R}^2 \mid V(x) < \frac{1}{4}\}$ .

• 8.17 Since  $\dot{V}(x)$  is negative, the vector field must point to the inside of the surface  $V(x) = c$ . Therefore, the directions (2) and (3) are possible, while (1) and (4) are impossible.

• 8.18 (a)

$$0 = x_2, \quad 0 = -x_2 - \sin x_1 - 2\text{sat}(x_1 + x_2)$$

Hence

$$\sin x_1 + 2\text{sat}(x_1) = 0 \Rightarrow x_1 = 0$$

The origin is the unique equilibrium point.

(b)

$$A = \left. \frac{\partial f}{\partial x} \right|_{x=0} = \begin{bmatrix} 0 & 1 \\ -\cos x_1 - 2 & -1 - 2 \end{bmatrix} \Big|_{x=0} = \begin{bmatrix} 0 & 1 \\ -3 & -3 \end{bmatrix}$$

The eigenvalues of  $A$  are  $-3/2 \pm j\sqrt{3}/2$ . Hence,  $A$  is Hurwitz and the origin is asymptotically stable.

(c)

$$\sigma \dot{\sigma} = \sigma[-\sin x_1 - 2\text{sat}(\sigma)] \leq |\sigma| - 2|\sigma| = -|\sigma|, \text{ for } |\sigma| \geq 1$$

(d)

$$\begin{aligned} \dot{V}(x) &= (2x_1 + \sin x_1)x_2 + x_2[-x_2 - \sin x_1 - 2\text{sat}(x_1 + x_2)] \\ &= -3x_2^2 \leq 0, \text{ for } |\sigma| \leq 1 \end{aligned}$$

The set  $M_c$  is closed and bounded. Its boundary is formed of four parts, two lying on the surface  $V(x) = c$ , one lying on the line  $\sigma = 1$ , and one lying on the line  $\sigma = -1$ . Since  $\dot{V}(x) \leq 0$  in  $M_c$ , trajectories cannot leave the set through the parts of the boundary on the surface  $V(x) = c$ . Using the result of part (c), we see that the trajectories cannot leave  $M_c$  through the lines  $\sigma = \pm 1$  since on those lines  $|\sigma|$  must be decreasing. Hence, every trajectory starting in  $M_c$  will remain in  $M_c$  for all future time. Let us find the largest invariant set in  $E = \{x \in M_c \mid \dot{V}(x) = 0\}$ .

$$\dot{V}(x) = 0 \Rightarrow x_2(t) \equiv 0 \Rightarrow \sin x_1(t) - 2x_1(t) \equiv 0 \Rightarrow x_1(t) \equiv 0$$

Hence, the origin is the largest invariant set in  $E$ . We conclude, by LaSalle's theorem, that every trajectory starting in  $M_c$  approaches the origin as  $t \rightarrow \infty$ .

(e) Since  $\sigma \dot{\sigma} \leq -|\sigma|$  for  $|\sigma| \geq 1$ , every trajectory starting outside the region  $|\sigma| \leq 1$  must reach this region in finite time. Suppose, for example, that the initial point is in the region  $\sigma > 1$ . Then

$$\sigma \dot{\sigma} \leq -\sigma \Rightarrow \dot{\sigma} \leq -1$$

Therefore  $\sigma(t) \leq \sigma(0) - t$ , which implies that the trajectory reaches the region  $|\sigma| \leq 1$  in time less than or equal to  $\sigma(0) - 1$ . A similar argument can be made if the trajectory starts in  $\sigma < -1$ . Once inside the region  $|\sigma| \leq 1$ , the trajectory belongs to a set  $M_c$  for some  $c > 0$ . It follows from part (d) that the trajectory reaches the origin as  $t \rightarrow \infty$ . Therefore, the origin is globally asymptotically stable.

## 《非线性系统（第三版）》习题解答

• 8.19 (a)

$$\dot{x}_1 = x_2, \quad \dot{x}_2 = \frac{1}{M}[-\eta_1 x_3 \sin x_1 - Dx_2 + P], \quad \dot{x}_3 = \frac{1}{\tau}[-\eta_3 \cos x_1 - \eta_2 x_3 + E_{FD}]$$

Equilibrium points:

$$0 = x_2, \quad 0 = \frac{1}{M}[-\eta_1 x_3 \sin x_1 - Dx_2 + P], \quad 0 = \frac{1}{\tau}[-\eta_3 \cos x_1 - \eta_2 x_3 + E_{FD}]$$

Substituting  $x_3$  from the third equation into the second one, we obtain

$$0.815 = \frac{2}{2.7}(1.7 \cos x_1 + 1.22) \sin x_1$$

Using “fzero” of MATLAB, we found two roots in the region  $-\pi \leq x_1 \leq \pi$ . The corresponding equilibrium points are:

$$p = \begin{bmatrix} 0.4067 \\ 0 \\ 1.301 \end{bmatrix}, \quad q = \begin{bmatrix} 1.6398 \\ 0 \\ 0.4085 \end{bmatrix}$$

$$\frac{\partial f}{\partial x} = \begin{bmatrix} 0 & 1 & 0 \\ -(\eta_1/M)x_3 \cos x_1 & -D/M & -(\eta_1/M) \sin x_1 \\ -(\eta_3/\tau) \sin x_1 & 0 & -(\eta_2/\tau) \end{bmatrix}$$

$$\left. \frac{\partial f}{\partial x} \right|_{x=p} = \begin{bmatrix} 0 & 1 & 0 \\ -128.7204 & -4 & -53.821 \\ -0.1019 & 0 & -0.4091 \end{bmatrix} \Rightarrow \text{Eigenvalues} = -2.0215 \pm j11.171, -0.366$$

$\Rightarrow p$  is asymptotically stable

$$\left. \frac{\partial f}{\partial x} \right|_{x=q} = \begin{bmatrix} 0 & 1 & 0 \\ 3.829 & -4 & -135.7311 \\ -0.257 & 0 & -0.4091 \end{bmatrix} \Rightarrow \text{Eigenvalues} = -3.4381 \pm j1.7179, 2.4671 \Rightarrow q \text{ is unstable}$$

(b) Estimate the region of attraction of  $p$ . Use  $V(x) = y^T P_1 y$ , where  $y = x - p$  and  $P_1$  is the solution of the Lyapunov equation  $P_1 A + A P_1 = -I$ . Using MATLAB,  $P_1$  was found to be

$$P_1 = \begin{bmatrix} 16.039 & -0.0013 & 6.6042 \\ -0.0013 & 0.1247 & -0.0239 \\ 6.6042 & -0.0239 & 4.3642 \end{bmatrix}$$

The eigenvalues of  $P_1$  are 19.0159, 1.3877, 0.1243. Set  $g(x) = f(x) - A(x - p)$ . We have

$$\begin{aligned} g_1(x) &= 0 \\ g_2(x) &= (\eta_1/M)[-x_3 \sin x_1 + p_3 \sin p_1 + p_3(x_1 - p_1) \cos p_1 + (x_3 - p_3) \sin p_1] \\ g_3(x) &= (\eta_3/\tau)[\cos x_1 - \cos p_1 + (x_1 - p_1) \sin p_1] \end{aligned}$$

$$\frac{\partial g_2}{\partial x_1} = (\eta_1/M)(-x_3 \cos x_1 + p_3 \cos p_1), \quad \frac{\partial g_2}{\partial x_3} = (\eta_1/M)(-\sin x_1 + \sin p_1), \quad \frac{\partial g_3}{\partial x_1} = (\eta_3/\tau)(-\sin x_1 + \sin p_1)$$

Using the mean value theorem, we obtain

$$|g_2(x)| \leq (\eta_1/M)(2|y_3| |y_3| + p_3 y_1^2), \quad |g_3(x)| \leq (\eta_3/\tau) y_1^2$$

We have

$$\dot{V} = -y^T y + 2y^T P_1 g$$

## 《非线性系统（第三版）》习题解答

$$P_1 g = \begin{bmatrix} p_{11} & p_{12} & p_{13} \\ p_{12} & p_{22} & p_{23} \\ p_{13} & p_{23} & p_{33} \end{bmatrix} \begin{bmatrix} 0 \\ g_2 \\ g_3 \end{bmatrix} = \begin{bmatrix} p_{12}g_2 + p_{13}g_3 \\ p_{22}g_2 + p_{23}g_3 \\ p_{32}g_2 + p_{33}g_3 \end{bmatrix}$$

$$\begin{aligned} |(P_1 g)_1| &\leq (\eta_1 |p_{12}|/M)(2|y_1| |y_3| + p_3 y_1^2) + (\eta_3 |p_{13}|/\tau) y_1^2 \stackrel{\text{def}}{=} a_1 y_1^2 + b_1 |y_1| |y_3| \\ |(P_1 g)_2| &\leq (\eta_1 |p_{22}|/M)(2|y_1| |y_3| + p_3 y_1^2) + (\eta_3 |p_{23}|/\tau) y_1^2 \stackrel{\text{def}}{=} a_2 y_1^2 + b_2 |y_1| |y_3| \\ |(P_1 g)_3| &\leq (\eta_1 |p_{23}|/M)(2|y_1| |y_3| + p_3 y_1^2) + (\eta_3 |p_{33}|/\tau) y_1^2 \stackrel{\text{def}}{=} a_3 y_1^2 + b_3 |y_1| |y_3| \end{aligned}$$

Hence

$$\|P_1 g\|_2^2 \leq a y_1^4 + 2b |y_1|^3 |y_3| + d y_1^2 y_3^2 = y_1^2 \begin{bmatrix} |y_1| \\ |y_3| \end{bmatrix}^T N \begin{bmatrix} |y_1| \\ |y_3| \end{bmatrix}$$

where  $a = a_1^2 + a_2^2 + a_3^2$ ,  $b = a_1 b_1 + a_2 b_2 + a_3 b_3$ ,  $d = b_1^2 + b_2^2 + b_3^2$ , and  $N = \begin{bmatrix} a & b \\ b & d \end{bmatrix}$ . Thus,

$$\|P_1 g\|_2 \leq \sqrt{\lambda_{\max}(N)} \|y\|_2^2$$

$$\dot{V} \leq -\|y\|_2^2 + 2\sqrt{\lambda_{\max}(N)} \|y\|_2^3$$

Let  $r = 1/2\sqrt{\lambda_{\max}(N)}$  and  $c = r^2 \lambda_{\min}(P_1) = \lambda_{\min}(P_1)/4\lambda_{\max}(N)$ . It can be verified that  $c = 1.8175 \times 10^{-5}$ . The set  $\{V(y) < c\}$  is an estimate of the region of attraction.

• 8.20

(a) Take  $V(x) = \frac{1}{2}(x_1^2 + x_2^2)$ . Then

$$\dot{V}(x) = x_1 x_2 - x_1 x_2 - g(t) x_2^2 \leq -k_1 x_2^2$$

Let

$$A(t) = \begin{bmatrix} 0 & 1 \\ -1 & -g(t) \end{bmatrix}, \quad \bar{A} = \begin{bmatrix} 0 & 1 \\ -1 & 0 \end{bmatrix}, \quad C(t) = [0 \quad \sqrt{g(t)}]$$

Using  $g(t) \geq k_1$ , it can be shown by calculating the observability Gramian that the pair  $(\bar{A}, C(t))$  is uniformly observable. Since  $A(t) = \bar{A} - C^T(t)C(t)$  and  $C(t)$  is uniformly bounded, we conclude that the pair  $(A(t), C(t))$  is uniformly observable. It can be easily verified that  $P = \frac{1}{2}I$  satisfies the equation

$$-\dot{P}(t) = P(t)A(t) + A^T(t)P(t) + C^T(t)C(t)$$

It follows from Theorem 8.5 and Example 8.11 that the origin is exponentially stable.

(b) With  $g(t) = 2 + e^t$ , the state equation is

$$\dot{x}_1 = x_2, \quad \dot{x}_2 = -x_1 - (2 + e^t)x_2$$

It can be verified that

$$x_1(t) = -(1 + e^{-t})k, \quad x_2(t) = e^{-t}k$$

is a solution for any constant  $k$ . Thus

$$x_1(t) \rightarrow -k \text{ and } x_2(t) \rightarrow 0 \text{ as } t \rightarrow \infty$$

This shows that the origin is not asymptotically stable. Hence, the boundedness of  $g(t)$  is necessary

• 8.21 Linearize the system at  $x = 0$ . The linearized system is studied in the previous exercise. The origin of the linearization is exponentially stable. Thus, by Theorem 4.13, the origin is an exponentially stable equilibrium point for the nonlinear system.

## 《非线性系统 (第三版)》习题解答

• 8.22

$$\dot{x} = \begin{bmatrix} -1 & -1 & -\alpha(t) \\ 1 & 0 & 0 \\ \alpha(t) & 0 & 0 \end{bmatrix} x = A(t)x$$

With  $V(x) = x^T x$ , we have

$$\dot{V}(x) = x^T [A(t) + A^T(t)]x = -x_1^2 = -x^T C^T C x$$

where  $C = [1, 0, 0]$ . Taking  $K(t) = [-1, 1, \alpha(t)]^T$  yields

$$A(t) - K(t)C = \begin{bmatrix} 0 & -1 & -\alpha(t) \\ 0 & 0 & 0 \\ 0 & 0 & 0 \end{bmatrix}$$

The transition matrix of  $[A(t) - K(t)C]$  is

$$\Phi(t, \tau) = \begin{bmatrix} 1 & -(t-\tau) & -\int_{\tau}^t \alpha(\sigma) d\sigma \\ 0 & 1 & 0 \\ 0 & 0 & 1 \end{bmatrix} \Rightarrow C\Phi(t, \tau) = \begin{bmatrix} 1 & -(t-\tau) & -\int_{\tau}^t \alpha(\sigma) d\sigma \end{bmatrix}$$

With  $\alpha(t) = \sin t + \sin 2t$ , it can be seen that the pair  $(A - KC, C)$  is uniformly observable. Exponential stability of the origin follows from Example 8.11.

• 8.23 (a)

$$\begin{aligned} \dot{e}_i &= \dot{x}_i - r^{(i)} = x_{i+1} - r^{(i)} = e_{i+1}, \quad 1 \leq i \leq n-1 \\ \dot{e}_n &= \dot{x}_n - r^{(n)} = f_0(x) + (\theta^*)^T f_1(x) + g_0(x)u - r^{(n)} \end{aligned}$$

Hence,  $e$  satisfies the equation

$$\dot{e} = Ae + B[f_0(x) + (\theta^*)^T f_1(x) + g_0(x)u - r^{(n)}]$$

where  $(A, B)$  is a controllable canonical pair that represents a chain of  $n$  integrators.

(b)

$$\begin{aligned} \dot{V} &= 2e^T P \dot{e} + 2\phi^T \Gamma^{-1} \dot{\phi} \\ &= 2e^T P \{ (A - BK)e + B[f_0(x) + (\theta^*)^T f_1(x) + g_0(x)u - r^{(n)} - Ke] \} + 2\phi^T \Gamma^{-1} \Gamma f_1(x) e^T P B \\ &= e^T [P(A - BK) + (A - BK)^T P] e + 2e^T P B [-\phi^T f_1(x)] + 2\phi^T f_1(x) e^T P B = -e^T e \end{aligned}$$

By Theorem 8.4, all state variables are bounded and  $\lim_{t \rightarrow \infty} e(t) = 0$ .

(c) The closed-loop system can be represented as the linear time-varying system

$$\dot{\mathcal{X}} = [A(t) + B(t)]\mathcal{X}, \quad e(t) = C\mathcal{X}$$

where

$$A(t) = \begin{bmatrix} A - BK & -B\bar{w}^T(t) \\ \Gamma\bar{w}(t)B^T P & 0 \end{bmatrix}, B(t) = \begin{bmatrix} 0 & -B(w(t) - \bar{w}(t))^T \\ \Gamma(w(t) - \bar{w}(t))B^T P & 0 \end{bmatrix}, \mathcal{X} = \begin{bmatrix} e \\ \phi \end{bmatrix}$$

$C = [I \ 0]$ ,  $w(t) = f_1(x(t))$ , and  $\bar{w}(t) = f_1(\mathcal{R}(t))$ . We want to show that the origin is exponentially stable. Since  $\lim_{t \rightarrow \infty} e(t) = 0$ , it is sufficient to prove exponential stability of the system (see Example 9.6)

$$\dot{\mathcal{X}} = \mathcal{A}(t)\mathcal{X}, \quad e(t) = C\mathcal{X}$$

It follows from Theorem 8.5 and Example 8.11 that the origin of the closed-loop system will be exponentially stable if the pair  $(A(t), C)$  is uniformly observable. Setting  $\mathcal{K}(t) = \begin{bmatrix} A - BK \\ \Gamma\bar{w}(t)B^T P \end{bmatrix}$ , It can be seen that  $\bar{A}(t) = A(t) - \mathcal{K}(t)C$ . Since uniform observability of  $(A(t), C)$  is equivalent to uniform observability of  $(A(t) - \mathcal{K}(t)C, C)$  for any piecewise continuous bounded  $\mathcal{K}(t)$ , we conclude that the origin of the closed-loop system will be exponentially stable if  $(\bar{A}(t), C)$  is uniformly observable. In this case,  $\lim_{t \rightarrow \infty} \phi(t) = 0$ .

## 《非线性系统（第三版）习题解答

### Chapter 9

• 9.1 (a) If  $P$  and  $Q$  satisfy the Lyapunov equation, then  $kP$  and  $kQ$  satisfy the same equation for any positive constant  $k$ . Thus

$$\mu(kQ) = \frac{\lambda_{\min}(kQ)}{\lambda_{\max}(kP)} = \frac{\lambda_{\min}(Q)}{\lambda_{\max}(P)} = \mu(Q)$$

(b) let

$$P_1 = \int_0^{\infty} \exp(A^T t) \exp(At) dt, \quad P_2 = \int_0^{\infty} \exp(A^T t) \hat{Q} \exp(At) dt$$

Then

$$\begin{aligned}
 P_1 - P_2 &= \int_0^{\infty} \exp(A^T t) [I - \hat{Q}] \exp(At) dt \\
 \hat{Q} \geq I &\Rightarrow I - \hat{Q} \leq 0 \Rightarrow P_1 - P_2 \leq 0 \Rightarrow P_2 \geq P_1
 \end{aligned}$$

Hence,  $\lambda_{\max}(P_2) \geq \lambda_{\max}(P_1)$  and

$$\frac{\mu(I)}{\mu(\hat{Q})} = \frac{\lambda_{\min}(I)}{\lambda_{\max}(P_1)} \times \frac{\lambda_{\max}(P_2)}{\lambda_{\min}(\hat{Q})} \geq 1$$

(c) For any  $Q = Q^T > 0$ , let  $k = 1/\lambda_{\min}(Q)$ . Define  $\hat{Q} = kQ$  so that  $\lambda_{\min}(\hat{Q}) = 1$ . Thus

$$\mu(I) \geq \mu(\hat{Q}) \geq \mu(Q), \quad \forall Q = Q^T > 0$$

• 9.2 (a) The function  $|h_i(v)|$  is sketched in Figure 9.1. From the sketch it is clear that

$$|h_i(v)| \leq \frac{\delta}{1+\delta} |v_i|, \quad \forall |v_i| \leq L(1+\delta)$$

(b) The derivative of  $V(x) = x^T P x$  along the trajectories of the system satisfies

$$\begin{aligned}
 \dot{V}(x) &= -x^T x - 2x^T P B h(Fx) \leq -\|x\|_2^2 + 2\|x\|_2 \|PB\|_2 \|h(Fx)\|_2 \\
 &\leq -\|x\|_2^2 + 2\|x\|_2 \|PB\|_2 \frac{\delta}{1+\delta} \|Fx\|_2 \leq -\|x\|_2^2 + \frac{2\delta}{1+\delta} \|PB\|_2 \|F\|_2 \|x\|_2^2 \\
 &< 0, \quad \text{for } \frac{\delta}{1+\delta} < \frac{1}{2\|PB\|_2 \|F\|_2}
 \end{aligned}$$

(c) The origin is asymptotically stable by Theorem 4.1. To estimate the region of attraction, find a constant  $c > 0$  such that the set  $\Omega_c = \{x \in R^n \mid x^T P x \leq c\}$  is inside the region  $|(Fx)_i| \leq L(1+\delta)$  for all  $i$ . The largest such constant is obtained by minimizing  $V(x)$  on the boundary of the region.

(d) We have

$$A - BF = \begin{bmatrix} 0 & 1 \\ -0.5 & -1 \end{bmatrix} \Rightarrow P = \begin{bmatrix} 1.75 & 1 \\ 1 & 1.5 \end{bmatrix} \Rightarrow 2\|PB\|_2 \|F\|_2 = 8.0623$$

## 《非线性系统（第三版）》习题解答

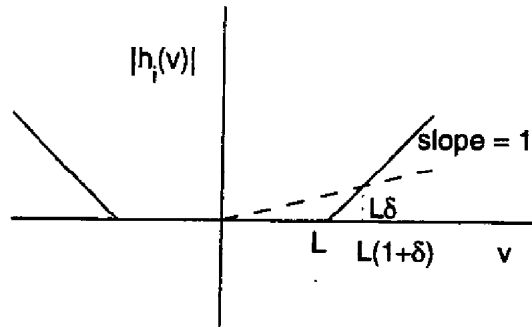

Figure 9.1: Exercise 9.2.

$$\frac{\delta}{1+\delta} < \frac{1}{8.0623} \Rightarrow \delta < \frac{1}{7.0623} = 0.1416$$

The region of interest is given by  $|Fx| < 1.1426$ . Take  $c < (1.1426)^2/[FP^{-1}F^T] = 0.724$ . The region of attraction is estimated by  $\{x^T Px \leq 0.723\}$ .

• 9.3

$$\begin{aligned} \dot{V}(t, x) &= \frac{\partial V}{\partial t} + \frac{\partial V}{\partial x} f(t, x) - \frac{\partial V}{\partial x} Bg(t, Cx) \leq -c_3 \|x\|_2^2 + c_4 \|x\|_2 \|B\|_2 \|g(t, Cx)\|_2 \\ &\leq -c_3 \|x\|_2^2 + c_4 \|x\|_2 \|B\|_2 \gamma \|C\|_2 \|x\|_2 = -[c_3 - \gamma c_4 \|B\|_2 \|C\|_2] \|x\|_2^2 \end{aligned}$$

For all  $\gamma < \gamma^* = c_3/(c_4 \|B\|_2 \|C\|_2)$ , the origin is globally exponentially stable.

• 9.4 The closed-loop system is given by

$$\dot{x} = (A - BB^T P)x + Bg(t, x)$$

Rewrite the Riccati equation as

$$P(A - BB^T P) + (A - BB^T P)^T P + Q + PBB^T P + 2\alpha P = 0$$

Consider  $V(x) = x^T Px$  as a Lyapunov function candidate.

$$\begin{aligned} \dot{V}(t, x) &= x^T [P(A - BB^T P) + (A - BB^T P)^T P]x + 2x^T PBg(t, x) \\ &= -x^T [Q + PBB^T P + 2\alpha P]x + 2x^T PBg(t, x) \\ &\leq -k^2 \|x\|_2^2 - \|w\|_2^2 - 2\alpha \lambda_{\min}(P) \|x\|_2^2 + 2k \|w\|_2 \|x\|_2, \quad \text{where } w = B^T Px \\ &= -[k \|x\|_2 - \|w\|_2]^2 - 2\alpha \lambda_{\min}(P) \|x\|_2^2 \leq -2\alpha \lambda_{\min}(P) \|x\|_2^2 \end{aligned}$$

Hence, the origin is globally exponentially stable.

• 9.5 The closed-loop system is given by

$$\dot{x} = \left( A - \frac{1}{2\varepsilon} BB^T P \right) x + Dg(t, y)$$

Let  $V(x) = x^T Px$ .

$$\begin{aligned} \dot{V}(x) &= x^T \left[ P \left( A - \frac{1}{2\varepsilon} BB^T P \right) + \left( A - \frac{1}{2\varepsilon} BB^T P \right)^T P \right] x + 2x^T PDg(t, y) \\ &= -\frac{1}{\gamma} x^T PDD^T Px - \frac{1}{\gamma} x^T C^T Cx - \varepsilon x^T Qx + 2x^T PDg(t, y) \\ &\leq -\frac{1}{\gamma} x^T PDD^T Px - \frac{1}{\gamma} \|y\|_2^2 - \varepsilon x^T Qx + 2\|x^T PD\|_2 k \|y\|_2 \end{aligned}$$

## 《非线性系统（第三版）》习题解答

Set  $z = D^T P x$ .

$$\begin{aligned}
 \dot{V}(x) &\leq -\frac{1}{\gamma} \|z\|_2^2 - \frac{1}{\gamma} \|y\|_2^2 - \varepsilon x^T Q x + 2k \|z\|_2 \|y\|_2 \\
 &\leq -\frac{1}{\gamma} \|z\|_2^2 - \frac{1}{\gamma} \|y\|_2^2 + k(\|z\|_2^2 + \|y\|_2^2) - \varepsilon x^T Q x \\
 &\leq -\varepsilon x^T Q x
 \end{aligned}$$

for  $\gamma < 1/k$ . Hence, the origin is globally exponentially stable.

• 9.6 (a) The perturbed system can be written as

$$\dot{x} = Ax + \|x\|_2^2 Bx, \quad \text{where } A = \begin{bmatrix} -\alpha & -\omega \\ \omega & -\alpha \end{bmatrix}, \quad B = \begin{bmatrix} \beta & -\gamma \\ \gamma & \beta \end{bmatrix}$$

$V(x) = x^T x$  is a Lyapunov function for the nominal system since  $A + A^T = -2\alpha I$ . The derivative of  $V$  along the trajectories of the perturbed system satisfies

$$\dot{V} \leq -2\alpha \|x\|_2^2 + 2\|B\|_2 \|x\|_2^4 = -2\alpha \|x\|_2^2 + 2\sqrt{\beta^2 + \gamma^2} \|x\|_2^4$$

For  $\|x\|_2 \leq r$ , we have

$$\dot{V} \leq -2\alpha \|x\|_2^2 + 2r^2 \sqrt{\beta^2 + \gamma^2} \|x\|_2^2 < 0, \quad \text{for } \sqrt{\beta^2 + \gamma^2} < \frac{\alpha}{r^2}$$

(b) Calculating the derivative of  $V$  directly (without viewing  $\|x\|_2^2 Bx$  as a perturbation term), we obtain

$$\dot{V} = -2\alpha \|x\|_2^2 + 2\beta \|x\|_2^4$$

When  $\beta \leq 0$ ,  $\dot{V} \leq -2\alpha \|x\|_2^2$  and the origin is globally exponentially stable. When  $\beta > 0$ , we have

$$\dot{V} \leq -2(\alpha - \beta r^2) \|x\|_2^2, \quad \forall \|x\|_2 \leq r$$

Hence,  $\dot{V}$  is negative definite when  $r^2 < \alpha/\beta$ . Since  $V(x) = \|x\|_2^2$ , we conclude that the set  $\{\|x\|_2^2 < \alpha/\beta\}$  is included in the region of attraction.

(c) Clearly, the results of (b) are less conservative than those of (a).

• 9.7  $f(x)$  can be written as  $f(x) = Ax + \tilde{f}(x)$ , where  $\tilde{f}(x)$  and its first-order partial derivatives vanish at  $x = 0$ . Take  $g(x) = Bx$  so that the perturbed system is given by  $\dot{x} = (A + B)x + \tilde{f}(x)$ . Since  $A$  has eigenvalues with zero real parts, for any  $\gamma > 0$ , there is  $B$  with  $\|B\| \leq \gamma$  such that at least one eigenvalue of  $(A + B)$  has a positive real part. Hence, the origin of the perturbed system is unstable.

• 9.8 (a) The derivative of  $V$  along the trajectories of the perturbed system is given by

$$\dot{V} = \frac{\partial V}{\partial x} f(x) + \frac{\partial V}{\partial x} g(x) \leq -\alpha_3(\|x\|) + \alpha_4(\|x\|)\gamma \|x\|$$

Let

$$a_1 = \min_{x \in \{V(x)=c\}} \alpha_3(\|x\|) > 0 \quad \text{and} \quad a_2 = \max_{x \in \Omega} \|x\| \alpha_4(\|x\|) > 0$$

Then, for all  $x \in \{V(x) = c\}$ , we have

$$\dot{V} \leq -a_1 + \gamma a_2 \leq 0, \quad \text{for } \gamma \leq a_1/a_2$$

## 《非线性系统 (第三版)》习题解答

Thus,  $\Omega$  is positively invariant for sufficiently small  $\gamma$ . Inside  $\Omega$ , we have

$$\dot{V} \leq -\alpha_3(\|x\|) + \gamma a_2 \leq -(1 - \theta)\alpha_3(\|x\|), \quad \forall \|x\| \geq \alpha_3^{-1} \left( \frac{\gamma a_2}{\theta} \right)$$

where  $0 < \theta < 1$ . The preceding inequality is valid as long as  $\alpha_3(\|x\|) \leq \gamma a_2 / \theta$  for all  $x \in \Omega$ , which is the case for sufficiently small  $\gamma$ . It follows from Theorem 4.18 that all solutions starting in  $\Omega$  are ultimately bounded by a class  $\mathcal{K}$  function of  $\gamma$ .

(b) Since  $A = \frac{\partial f}{\partial x}(0)$  is Hurwitz, the origin of  $\dot{x} = f(x)$  is exponentially stable. By Theorem 4.14, there is  $r_0 > 0$  and a Lyapunov function  $\tilde{V}(x)$  such that

$$c_1 \|x\|^2 \leq \tilde{V}(x) \leq c_2 \|x\|^2, \quad \frac{\partial \tilde{V}}{\partial x} f(x) \leq -c_3 \|x\|^2, \quad \left\| \frac{\partial \tilde{V}}{\partial x} \right\| \leq c_4 \|x\|$$

for all  $\|x\| \leq r_0$ , where  $c_1$  to  $c_4$  are positive constants. The derivative of  $\tilde{V}$  along the trajectories of the perturbed system is given by

$$\dot{V} = \frac{\partial \tilde{V}}{\partial x} f(x) + \frac{\partial \tilde{V}}{\partial x} g(x) \leq -(c_3 - \gamma c_4) \|x\|^2$$

Hence, there is  $c_0 > 0$  (independent of  $\gamma$ ) such that for all  $\gamma < c_3/c_4$ , the set  $\tilde{\Omega} = \{\tilde{V}(x) \leq c_0\}$  is positive invariant and every trajectory in  $\tilde{\Omega}$  converges to the origin as  $t$  tends to infinity. For sufficiently small  $\gamma$ , the ultimate bound of part (a) will be small enough to ensure that every trajectory starting in  $\Omega$  enters  $\tilde{\Omega}$  in finite time. Hence, every trajectory starting in  $\Omega$  converges to the origin as  $t$  tends to infinity.

(c) If  $A$  is not Hurwitz, we cannot ensure that the origin of the perturbed system is exponentially stable. Hence, the proof of part (b) falls apart; that is, we can show uniform ultimate boundedness but we cannot show that the trajectories will converge to the origin. In fact, the example given in the problem statement is a counter example where the trajectories do not converge to the origin for all  $x(0)$ . For this example, we have

$$A = \frac{\partial f}{\partial x} \Big|_{x=0} = \begin{bmatrix} 0 & -1 & 0 \\ 1 & 0 & 0 \\ 0 & 1 & 0 \end{bmatrix}$$

which is not Hurwitz since all its eigenvalues are on the imaginary axis. On the other hand, the derivative of  $V(x) = x_1^2 + \frac{1}{2}x_2^2 + \frac{1}{2}x_3^2 + x_1x_3$  along the trajectories of the nominal system is given by  $\dot{V}(x) = -(2x_1 + x_3)^4 \leq 0$ .

$$\dot{V}(x) = 0 \Rightarrow 2x_1(t) + x_3(t) \equiv 0 \Rightarrow 2\dot{x}_1(t) + \dot{x}_3(t) \equiv 0 \Rightarrow x_2(t) \equiv 0$$

Hence, by LaSalle's theorem, the origin is asymptotically stable. It follows from Theorem 4.16 that there is a Lyapunov function  $V(x)$  that satisfies the given inequalities in some domain around the origin. Finally, the linearization of the perturbed system at the origin is given by

$$\frac{\partial(f+g)}{\partial x} \Big|_{x=0} = \begin{bmatrix} a & -1 & -a \\ 1 & 0 & 0 \\ 0 & 1 & 0 \end{bmatrix}$$

and its characteristic equation is  $\lambda^3 - a\lambda^2 + \lambda + a = 0$ . By the Routh-Hurwitz criterion, it can be seen that this matrix has at least one eigenvalue in the right-half plane. Hence, the origin of the perturbed system is unstable.

### • 9.9 (a)

$$\dot{x}_1 = -x_1^3 + x_2^5, \quad \dot{x}_2 = -x_1^3 - x_2^5$$

Linearization at the origin yields the matrix  $A = 0$  which is not Hurwitz. Hence, the origin is not exponentially stable. Let  $V(x) = \frac{1}{4}x_1^4 + \frac{1}{6}x_2^6$ .

$$\dot{V} = x_1^3(-x_1^3 + x_2^5) + x_2^5(-x_1^3 - x_2^5) = -x_1^6 - x_2^{10}$$



## 《非线性系统（第三版）》习题解答

Hence, the origin is globally asymptotically stable.

(b) Linearization at the origin yields the matrix  $\begin{bmatrix} 0 & -\gamma \\ \gamma & \gamma \end{bmatrix}$  whose eigenvalues are  $\gamma/2 \pm j\gamma\sqrt{3}/2$ . Hence, the origin is unstable. The derivative of  $V$  along the trajectories of the perturbed system is given by

$$\begin{aligned}
 \dot{V} &= -x_1^6 - x_2^{10} - \gamma x_1^3 x_2 + \gamma x_1 x_2^5 + \gamma x_2^6 \\
 &\leq -x_1^6 - x_2^{10} + \frac{\gamma}{2}(x_1^6 + x_2^2) + \frac{\gamma}{2}(x_1^2 + x_2^{10}) + \gamma x_2^6 \\
 &= -\left(1 - \frac{\gamma}{2}\right)x_1^6 - \left(1 - \frac{\gamma}{2}\right)x_2^{10} + \frac{\gamma}{2}x_1^2 + \frac{\gamma}{2}x_2^2 + \gamma x_2^6 \\
 &\leq -\frac{3}{4}x_1^6 - \frac{3}{4}x_2^{10} + \frac{\gamma}{2}x_1^2 + \frac{\gamma}{2}x_2^2 + \gamma x_2^6 \\
 &\leq -\frac{1}{4}(x_1^6 + x_2^{10}), \quad \text{for } |x_1| \geq \gamma^{1/4} \text{ and } |x_2| \geq [\gamma + \sqrt{\gamma^2 + \gamma}]^{1/4}
 \end{aligned}$$

For  $|x_1| < \gamma^{1/4}$ , we have

$$\dot{V} \leq -\frac{3}{4}x_1^6 - \frac{3}{4}x_2^{10} + \frac{\gamma^{3/2}}{2} + \frac{\gamma}{2}x_2^2 + \gamma x_2^6$$

Let  $\rho_1(\gamma)$  be the largest positive real root of the polynomial equation

$$-\frac{1}{2}y^{10} + \frac{\gamma^{3/2}}{2} + \frac{\gamma}{2}y^2 + \gamma y^6$$

$\rho_1(\gamma)$  is a class  $\mathcal{K}$  function of  $\gamma$  and  $\rho_1(\gamma) \geq [\gamma + \sqrt{\gamma^2 + \gamma}]^{1/4}$ . Hence, for  $|x_1| < \gamma^{1/4}$ , we have

$$\dot{V} \leq -\frac{1}{4}(x_1^6 + x_2^{10}), \quad \forall |x_2| \geq \rho_1(\gamma)$$

For  $|x_2| < [\gamma + \sqrt{\gamma^2 + \gamma}]^{1/4}$ , we have

$$\dot{V} \leq -\frac{3}{4}x_1^6 - \frac{3}{4}x_2^{10} + \frac{\gamma}{2}x_1^2 + \frac{\gamma}{2}[\gamma + \sqrt{\gamma^2 + \gamma}]^{1/2} + \gamma[\gamma + \sqrt{\gamma^2 + \gamma}]^{3/2}$$

Let  $\rho_2(\gamma)$  be the largest positive real root of the polynomial equation

$$-\frac{1}{2}y^6 + \frac{\gamma}{2}y^2 + \frac{\gamma}{2}[\gamma + \sqrt{\gamma^2 + \gamma}]^{1/2} + \gamma[\gamma + \sqrt{\gamma^2 + \gamma}]^{3/2}$$

$\rho_2(\gamma)$  is a class  $\mathcal{K}$  function of  $\gamma$  and  $\rho_2(\gamma) \geq \gamma^{1/4}$ . Hence, for  $|x_2| < [\gamma + \sqrt{\gamma^2 + \gamma}]^{1/4}$ , we have

$$\dot{V} \leq -\frac{1}{4}(x_1^6 + x_2^{10}), \quad \forall |x_1| \geq \rho_2(\gamma)$$

setting  $\mu = \max\{\rho_1(\gamma), \rho_2(\gamma)\}$ , we see that the inequality  $\dot{V} \leq -\frac{1}{4}(x_1^6 + x_2^{10})$  is satisfied for all  $\|x\|_\infty \geq \mu$ . The conclusion follows from Theorem 4.18.

• 9.10 (a) With  $q = 0$ , we have

$$\dot{V} = -acx_1 \sin x_1 - bcx_1^2 - cx_2^2 \leq -(b-a)cx_1^2 - cx_2^2$$

which is negative definite for all  $x$ , since  $b > a$ .

(b) With  $q \neq 0$ , we have

$$\dot{V} = -acx_1 \sin x_1 - bcx_1^2 - cx_2^2 + (cx_1 + 2x_2)q(t) \cos x_1 \leq -(b-a)cx_1^2 - cx_2^2 + k\sqrt{c^2 + 4} \|x\|_2$$

Hence, the solutions are globally uniformly ultimately bounded and the ultimate bound is proportional to  $k$ . An estimate of the ultimate bound can be obtained using Theorem 4.18.

## 《非线性系统（第三版）》习题解答

- 9.11 (a) With  $b = 0$ , we have

$$\dot{x}_1 = [(\sin x_2)^2 - 1] x_1, \quad \dot{x}_2 = -x_2$$

Linearization at the origin yields the Hurwitz matrix  $A = -I$ ; hence the origin is exponentially stable. Global asymptotic stability can be seen by solving the equations to obtain

$$x_1(t) = x_1(0) \exp \left[ \int_0^t (\sin^2(e^{-2\tau} x_2(0)) - 1) d\tau \right], \quad x_2(t) = e^{-t} x_2(0)$$

It is clear that for all initial states, the solution  $x(t)$  tends to zero as  $t$  tends to infinity.

(b) Exponential stability for sufficiently small  $b$  follows from Lemma 9.1. To show that the origin is not globally asymptotically stable, show that there are other equilibrium points. In particular, there is an equilibrium point at  $x_1 = -(1+b)\pi/2b$ ,  $x_2 = \pi/2$ .

(c) While we cannot apply Lemma 9.1 because the Jacobian matrix is not globally bounded, the lemma hints that the origin of the nominal system is not globally exponentially stable because if it was so we would have expected the origin of the perturbed system to be globally exponential stable as well. The fact that the origin of the nominal system is not globally exponentially stable can be seen from the closed-form solution given in part (a).

- 9.12 (a) Let  $b = 0$ . Try  $V(x) = \frac{1}{2}x_1^2 + \frac{1}{2}x_2^2$ .

$$\dot{V}(x) = -x_1^2 + x_1x_2(x_1 + a) - x_1x_2(x_1 + a) = -x_1^2$$

$$\dot{V}(x) = 0 \Rightarrow x_1(t) \equiv 0 \Rightarrow ax_2(t) \equiv 0 \Rightarrow x_2(t) \equiv 0$$

Thus, the origin is globally asymptotically stable. To investigate exponential stability, linearize at  $x = 0$ .

$$A = \left. \frac{\partial f}{\partial x} \right|_{x=0} = \begin{bmatrix} -1 + x_2 & x_1 + a \\ -2x_1 - a & 0 \end{bmatrix}_{x=0} = \begin{bmatrix} -1 & a \\ -a & 0 \end{bmatrix}$$

The characteristic equation of  $A$  is  $\lambda^2 + \lambda + a^2 = 0$ . Hence,  $A$  is Hurwitz and the origin is exponentially stable.

(b) Let  $b > 0$ .  $A = \left. \frac{\partial f}{\partial x} \right|_{x=0} = \begin{bmatrix} -1 & a \\ -a & b \end{bmatrix}$ . The characteristic equation of  $A$  is  $\lambda^2 + (1-b)\lambda + a^2 - b = 0$ .

Hence,  $A$  is Hurwitz if  $b < \min\{1, a^2\}$ .

(c) For  $b > 0$ , the equilibrium points are

$$(0, 0), \quad \left( -a + \sqrt{b}, \frac{-a + \sqrt{b}}{\sqrt{b}} \right), \quad \left( -a - \sqrt{b}, \frac{a + \sqrt{b}}{\sqrt{b}} \right)$$

Since the system has multiple equilibria, the origin is not globally asymptotically stable.

(d) While we cannot apply Lemma 9.1 because the Jacobian matrix is not globally bounded, the lemma hints that the origin of the nominal system is not globally exponentially stable because if it was so we would have expected the origin of the perturbed system to be globally exponential stable as well. It is possible to show that the origin of the nominal system is not globally exponentially stable by a contradiction argument that involves deriving a special converse Lyapunov function for this example. The argument is long and can be found in the solution manual of the first edition (See Exercise 4.25).

- 9.13 (a)  $V(x) = x^4$  satisfies (9.11) with  $\alpha_1(r) = \alpha_2(r) = r^4$ .

$$\dot{V}(x) = 4x^3\dot{x} = -\frac{4x^4}{1+x^2} \Rightarrow \dot{V}(x) \leq -\alpha_3(|x|), \quad \text{with } \alpha_3(r) = \frac{4r^4}{1+r^2}$$

## 《非线性系统（第三版）习题解答

$$\left| \frac{dV}{dx} \right| = 4|x|^3 \leq \alpha_4(|x|), \quad \text{with } \alpha_4(r) = 4r^3$$

(b)  $\alpha_1(\cdot)$ ,  $\alpha_2(\cdot)$ , and  $\alpha_4(\cdot)$  are clearly class  $\mathcal{K}_\infty$  functions.  $\alpha_3(r)$  is monotonically increasing and  $\alpha_3(r) \rightarrow \infty$  as  $r \rightarrow \infty$ . Hence,  $\alpha_3(\cdot)$  belongs to class  $\mathcal{K}_\infty$ .

(c)

$$\frac{\alpha_3(\alpha_2^{-1}(\alpha_1(r)))}{\alpha_4(r)} = \frac{\alpha_3(r)}{\alpha_4(r)} = \frac{4r^4}{4r^3(1+r^2)} = \frac{r}{1+r^2} \rightarrow 0 \text{ as } r \rightarrow \infty$$

(d)

$$\left| \frac{x}{1+x^2} \right| = \frac{|x|}{1+x^2} \leq \frac{1}{2}, \quad \forall |x|$$

$$\delta > \frac{1}{2} \Rightarrow \dot{x} = \frac{-x}{1+x^2} + \delta > 0$$

Hence, the solution  $x(t)$  escapes to  $\infty$  for any initial state  $x(0)$ .

• 9.14 Let  $V(t, x(t)) = 0$ .

$$\begin{aligned} D_+W &= \limsup_{h \rightarrow 0^+} \frac{1}{h} [W(t+h, x(t+h)) - W(t, x(t))] \\ &= \limsup_{h \rightarrow 0^+} \frac{1}{h} \sqrt{V(t+h, x(t+h))} \end{aligned}$$

We have

$$\begin{aligned} V(t+h, x(t+h)) &\leq \frac{c_4}{2} \|x(t+h)\|^2 \\ x(t+h) &= h[f(t, 0) + g(t, 0)] + o(h) \Rightarrow \|x(t+h)\|^2 = h^2 \|g(t, 0)\|^2 + ho(h) \\ \frac{1}{h^2} V(t+h, x(t+h)) &\leq \frac{c_4}{2} \|g(t, 0)\|^2 + \frac{o(h)}{h} \leq \frac{c_4}{2} \delta^2(t) + \frac{o(h)}{h} \\ \limsup_{h \rightarrow 0^+} \frac{1}{h} \sqrt{V(t+h, x(t+h))} &\leq \sqrt{\frac{c_4}{2}} \delta(t) \leq \sqrt{\frac{c_4}{2c_1}} \sqrt{\frac{c_4}{2}} \delta(t) \end{aligned}$$

since  $\sqrt{c_4/2c_1} \geq 1$ . Thus,  $D_+W \leq c_4 \delta(t) / (2\sqrt{c_1})$ , which agrees with the right hand side of (9.17) at  $W = 0$ .

• 9.15 As in Example 9.6, the perturbation term  $B(t)x$  satisfies (9.15) with  $\gamma(t) = \|B(t)\|_2$  and  $\delta(t) = 0$ .

$$\frac{1}{\Delta} \int_t^{t+\Delta} \gamma(\tau) d\tau \leq \frac{1}{\Delta} \int_0^\infty \gamma(\tau) d\tau \leq \frac{k}{\Delta}$$

where  $k$  is independent of  $\Delta$ . Given  $\varepsilon > 0$ , we can choose  $\Delta$  large enough so that  $(k/\Delta) < \varepsilon$ . We conclude from Corollary 9.1 and the third case of Lemma 9.5 that the origin is globally exponentially stable.

• 9.16 As in Example 9.6, the perturbation term  $B(t)x$  satisfies (9.15) with  $\gamma(t) = \|B(t)\|_2$  and  $\delta(t) = 0$ .

$$\begin{aligned} \frac{1}{\Delta} \int_t^{t+\Delta} \gamma(\tau) d\tau &\leq \frac{1}{\Delta} \sqrt{\Delta \int_t^{t+\Delta} \gamma^2(\tau) d\tau} \\ &\leq \frac{1}{\sqrt{\Delta}} \sqrt{\int_0^\infty \gamma^2(\tau) d\tau} \leq \frac{k}{\sqrt{\Delta}} \end{aligned}$$

where  $k$  is independent of  $\Delta$ . Given  $\varepsilon > 0$ , we can choose  $\Delta$  large enough so that  $(k/\sqrt{\Delta}) < \varepsilon$ . We conclude from Corollary 9.1 and the third case of Lemma 9.5 that the origin is globally exponentially stable.

## 《非线性系统（第三版）》习题解答

• 9.17 Write  $A(t) = \bar{A} + B(t)$ , where  $B(t) = A(t) - \bar{A}$ . Since  $\bar{A}$  is Hurwitz and  $B(t) \rightarrow 0$  as  $t \rightarrow \infty$ , the result follows from Example 9.6.

• 9.18 Using the third case of Lemma 9.6, we conclude that  $x(t) \rightarrow 0$  as  $t \rightarrow \infty$ .

• 9.19 We view the system  $\dot{x} = f(t, x)$  as a perturbation of the nominal system  $\dot{x} = f(0, x)$ . Noting that  $A + A^T = -2\alpha I$  and  $B + B^T = 2\beta I$ , we use  $V(x) = x^T x$ . The derivative of  $V$  along the trajectories of the nominal system is given by

$$\dot{V} = x^T(A + A^T)x - \|x\|_2^2 x^T(B + B^T)x = -2\alpha\|x\|_2^2 - 2\beta\|x\|_2^4 \leq -2\alpha\|x\|_2^2$$

Thus,  $V$  satisfies (9.3)–(9.5) globally. Since  $\gamma(t) \rightarrow 0$  as  $t \rightarrow \infty$ , we conclude from Corollary 9.1 and the second case of Lemma 9.5 that the origin is globally exponentially stable.

• 9.20 Let  $V(x) = x^T P x$ .

$$\begin{aligned} \dot{V} &= 2x^T P[f(x) - \sigma G(x)G^T(x)Px] + 2x^T P w(t) = 2x^T P f(x) - 2\sigma x^T P G(x)G^T(x)Px + 2x^T P w(t) \\ &\leq -\gamma x^T P x - W(x) + 2x^T P w(t) \leq -\gamma V(x) + 2\|x\|_2 \lambda_{\max}(P)(a + ce^{-t}) \end{aligned}$$

Let  $U(t) = \sqrt{V(x(t))}$ .

$$\dot{U} \leq -\frac{\gamma}{2}U(t) + \frac{\lambda_{\max}(P)}{\sqrt{\lambda_{\min}(P)}}(a + ce^{-t})$$

Application of the comparison lemma yields

$$U(t) \leq \exp(-\gamma t/2)U(0) + \int_0^t \exp[-(\gamma/2)(t-\tau)] \frac{\lambda_{\max}(P)}{\sqrt{\lambda_{\min}(P)}}(a + ce^{-\tau}) d\tau$$

The right-hand side approaches  $(2a/\gamma)[\lambda_{\max}(P)/\sqrt{\lambda_{\min}(P)}]$  as  $t$  tends to infinity. Hence, an ultimate bound on  $U(t)$  can be taken as  $(2ka/\gamma)[\lambda_{\max}(P)/\sqrt{\lambda_{\min}(P)}]$  for  $k > 1$ . Since  $\|x\|_2 \leq \sqrt{V/\lambda_{\min}(P)}$ , an ultimate bound on  $\|x\|_2$  can be taken as  $(2ka/\gamma)[\lambda_{\max}(P)/\lambda_{\min}(P)]$ .

• 9.21 The perturbation term satisfies (9.15) with  $\gamma = 0$ . Therefore, (9.18) takes the form

$$\begin{aligned} W(t) &\leq e^{-\sigma(t-t_0)}W(t_0) + \int_{t_0}^t e^{-\sigma(t-\tau)}k\delta(\tau) d\tau, \quad \forall t \geq t_0 \\ W(t_0 + (i+1)\Delta) &\leq e^{-\sigma\Delta}W(t_0 + i\Delta) + \int_{t_0+i\Delta}^{t_0+(i+1)\Delta} e^{-\sigma(t_0+(i+1)\Delta-\tau)}k\delta(\tau) d\tau \\ &\leq e^{-\sigma\Delta}W(t_0 + i\Delta) + \int_{t_0+i\Delta}^{t_0+(i+1)\Delta} k\delta(\tau) d\tau \leq e^{-\sigma\Delta}W(t_0 + i\Delta) + k\eta\Delta \end{aligned}$$

Hence

$$W(t_0 + i\Delta) \leq (e^{-\sigma\Delta})^i W(t_0) + \sum_{j=0}^{i-1} (e^{-\sigma\Delta})^{i-j-1} k\eta\Delta \leq W(t_0) + \frac{k\eta\Delta}{1 - e^{-\sigma\Delta}}$$

Between any two sampling points  $t_0 + i\Delta$  and  $t_0 + (i+1)\Delta$ , we have

$$W(t) \leq e^{-\sigma(t-t_0-i\Delta)}W(t_0 + i\Delta) + \int_{t_0+i\Delta}^t e^{-\sigma(t-\tau)}k\delta(\tau) d\tau \leq W(t_0 + i\Delta) + k\eta\Delta$$

Thus

$$W(t) \leq W(t_0) + \frac{k\eta\Delta}{1 - e^{-\sigma\Delta}} + k\eta\Delta, \quad \forall t_0 + i\Delta \leq t \leq t_0 + i\Delta + \Delta$$

## 《非线性系统（第三版）》习题解答

Setting  $k_1 = k(2 - e^{-\sigma\Delta})/(1 - e^{-\sigma\Delta})$ , we can rewrite the foregoing inequality as

$$W(t) \leq W(t_0) + k_1\eta\Delta, \quad \forall t_0 + i\Delta \leq t \leq t_0 + i\Delta + \Delta$$

Recall that  $W(t) = \sqrt{V(t, x(t))}$ . Hence

$$W(t_0) \leq \sqrt{c_2}\|x(t_0)\|_2, \quad \text{and } W(t) \geq \sqrt{c_1}\|x(t)\|_2$$

Thus

$$\|x(t)\|_2 \leq \sqrt{\frac{c_2}{c_1}}\|x(t_0)\|_2 + \frac{k_1\eta\Delta}{\sqrt{c_1}}$$

Given  $\varepsilon > 0$  and  $\Delta > 0$ , choose  $\eta$  and  $\rho$  small enough to satisfy

$$\sqrt{\frac{c_2}{c_1}}\rho + \frac{k_1\eta\Delta}{\sqrt{c_1}} < \varepsilon$$

• 9.22 Prove by induction that all the principal minors of  $A$  are positive. It is clear that  $a_{11} > 0$  and

$$\det \begin{bmatrix} a_{11} & a_{12} \\ a_{21} & a_{22} \end{bmatrix} = a_{11}a_{22} - a_{12}a_{21} > a_{11}a_{22} - |a_{12}||a_{21}| > 0$$

Now assume that the  $m$ th-order principal minor  $\det A_m > 0$  and write the  $(m+1)$ th-order principal minor as  $\det A_{m+1}$ , where

$$A_{m+1} = \begin{bmatrix} A_m & b \\ c^T & d \end{bmatrix}$$

and  $A_m$ ,  $b$ ,  $c^T$ , and  $d$  have dimensions  $m \times m$ ,  $m \times 1$ ,  $1 \times m$ , and  $1 \times 1$ , respectively. All the elements of  $b$  and  $c$  are nonpositive and  $d > 0$ . We have

$$\det A_{m+1} = \det A_m \det(d - c^T A_m^{-1} b)$$

From the diagonal dominance property, all the elements of  $A_m^{-1}$  are nonnegative. It follows that all the elements of  $(d - c^T A_m^{-1} b)$  are nonnegative. To see this point consider the equation

$$\begin{aligned} A_m v + b &= w_1 \\ c^T v + d &= w_2 \end{aligned}$$

where  $v$  is a vector of ones. Due to diagonal dominance,  $w_1$  and  $w_2$  have positive components. After a simple manipulation we write

$$d - c^T A_m^{-1} b = w_2 - c^T A_m^{-1} w_1$$

Since  $c$  has nonpositive elements,  $A_m^{-1}$  has nonnegative elements, and  $w_1$  has positive elements, we conclude that  $-c^T A_m^{-1} w_1 \geq 0$ . Thus,  $d - c^T A_m^{-1} b > 0$ . Therefore,  $\det A_{m+1} > 0$  and the proof is complete.

• 9.23 If  $\phi_i(x_i) = \|x_i\|$ , then

$$\dot{V}(t, x) \leq -\frac{1}{2}\lambda_{\min}(DS + S^T D) \sum \phi_i^2(x_i) \leq -c_3\|x\|^2$$

for some  $c_3 > 0$ . If

$$c_{i1}\|x_i\|^2 \leq V_i(t, x_i) \leq c_{i2}\|x_i\|^2$$

then

$$V(t, x) = \sum d_i V_i(t, x_i) \leq \sum d_i c_{i2} \|x_i\|^2 \leq c_2 \|x\|^2$$

and, similarly,  $V(t, x) \geq c_1 \|x\|^2$ . The conclusion follows from Theorem 4.10.

## 《非线性系统（第三版）》习题解答

• 9.24 A direct application of Theorem 9.2 will not be conclusive. Therefore, we proceed to perform the composite Lyapunov analysis as follows. Write the state equation as

$$\dot{x}_1 = -x_1^3 + g_1(x), \quad \dot{x}_2 = -x_2^5 + g_2(x)$$

where  $g_1(x) = -1.5x_1|x_2|^3$  and  $g_2(x) = x_1^2x_2^2$ . We try  $V_1(x_1) = \frac{1}{2}x_1^2$  and  $V_2(x_2) = \frac{1}{2}x_2^2$  as Lyapunov function candidates for the isolated subsystems.

$$\frac{dV_1}{dx_1}(-x_1^3) = -x_1^4 = -\phi_1^2(x_1), \text{ where } \phi_1(x_1) = x_1^2$$

$$\frac{dV_2}{dx_2}(-x_2^5) = -x_2^6 = -\phi_2^2(x_2), \text{ where } \phi_2(x_2) = |x_2|^3$$

Next, we study the interconnection terms.

$$\frac{dV_1}{dx_1}g_1(x) = -1.5x_1^2|x_2|^3 = -1.5\phi_1\phi_2$$

$$\frac{dV_2}{dx_2}g_2(x) = x_1^2x_2^3 \leq \phi_1\phi_2$$

Consider the composite Lyapunov function  $V(x) = d_1V_1(x_1) + d_2V_2(x_2)$ .

$$\dot{V}(x) \leq -\frac{1}{2} \begin{bmatrix} \phi_1 \\ \phi_2 \end{bmatrix}^T \begin{bmatrix} 2d_1 & 1.5d_1 - d_2 \\ 1.5d_1 - d_2 & 2d_2 \end{bmatrix} \begin{bmatrix} \phi_1 \\ \phi_2 \end{bmatrix}$$

For  $\dot{V}$  to be negative definite, we want the  $2 \times 2$  matrix to be positive definite. Choosing  $d_1 = d_2 = 1$  results in a positive definite matrix. Hence, the origin is asymptotically stable.

• 9.25 Use the notation of Section 9.5. Represent the system as an interconnection of two subsystems.

$$\begin{bmatrix} \dot{x}_1 \\ \dot{x}_2 \end{bmatrix} = \begin{bmatrix} 0 & 1 \\ -1 & -1 \end{bmatrix} \begin{bmatrix} x_1 \\ x_2 \end{bmatrix} + \begin{bmatrix} x_2x_3^3 \\ x_1^2 \end{bmatrix}$$

$$\dot{x}_3 = \begin{bmatrix} 1 & 1 \end{bmatrix} \begin{bmatrix} x_1 \\ x_2 \end{bmatrix} - x_3^3$$

Use

$$V_1(x_1, x_2) = \begin{bmatrix} x_1 \\ x_2 \end{bmatrix}^T \begin{bmatrix} 1.5 & 0.5 \\ 0.5 & 1 \end{bmatrix} \begin{bmatrix} x_1 \\ x_2 \end{bmatrix}$$

as a Lyapunov function candidate for the first isolated subsystem.

$$\dot{V}_1|_{\text{isolated}} = -x_1^2 - x_2^2 \Rightarrow \alpha_1 = 1, \phi_1 = \sqrt{x_1^2 + x_2^2}$$

We also have  $\beta_1 = 1.809$ . Use  $V_2(x_3) = \frac{1}{4}x_3^4$  as a Lyapunov function candidate for the second isolated subsystem.

$$\dot{V}_2|_{\text{isolated}} = -x_3^6 \Rightarrow \alpha_2 = 1, \phi_2 = |x_3|^3$$

We also have  $\beta_2 = 1$ . The interconnection terms satisfy

$$\|g_1\|_2 \leq c_1\sqrt{2}\phi_1 + c_2\sqrt{2}\phi_2$$

in the set  $\{|x_1| \leq c_1, |x_2| \leq c_2\}$ .

$$|g_2| \leq \sqrt{2}\phi_1$$

## 《非线性系统（第三版）》习题解答

The matrix  $S$  is given by

$$S = \begin{bmatrix} 1 - 1.809\sqrt{2}c_1 & -1.809\sqrt{2}c_2 \\ -\sqrt{2} & 1 \end{bmatrix}$$

$S$  is an  $M$ -matrix if

$$1 - 1.809\sqrt{2}c_1 - 3.618c_2 > 0$$

which can be ensured by choosing  $c_1$  and  $c_2$  small enough. Thus, the origin is asymptotically stable.

• **9.26** Use the notation of Section 9.5. Let  $P_i$  be the solution of the Lyapunov equation  $P_i A_{ii} + A_{ii}^T P_i = -I_i$  and use  $V_i(x_i) = x_i^T P_i x_i$  as a Lyapunov function for the  $i$ th isolated system.

$$\begin{aligned} \frac{\partial V_i}{\partial x_i} A_{ii} x_i &= -\|x_i\|_2^2 \Rightarrow \alpha_i = 1, \phi_i = \|x_i\|_2 \\ \left\| \frac{\partial V_i}{\partial x_i} \right\|_2 &\leq 2\|P_i\|_2 \|x_i\|_2 \Rightarrow \beta_i = 2\|P_i\|_2 \end{aligned}$$

The interconnection terms satisfy

$$\|g_i(x)\|_2 \leq \sum_{j=1}^m \|A_{ij}\|_2 \|x_j\|_2 \Rightarrow \gamma_{ij} = \|A_{ij}\|_2$$

The matrix  $S$  is defined by

$$s_{ij} = \begin{cases} 1, & \text{for } j = i \\ -2\|P_i\|_2 \|A_{ij}\|_2, & \text{for } j \neq i \end{cases}$$

The origin is asymptotically stable if  $S$  is an  $M$ -matrix.

• **9.27** Since  $0 \leq e_{ij} \leq 1$ , we have

$$\|g_i(t, e_{i1}x_1, \dots, e_{im}x_m)\| \leq \sum_{j=1}^m e_{ij} \gamma_{ij} \phi_j(x_j) \leq \sum_{j=1}^m \gamma_{ij} \phi_j(x_j)$$

Thus, the conditions of Theorem 9.2 are satisfied irrespective of the values of  $e_{ij}$ .

• **9.28 (a)** The closed-loop system is given by

$$\begin{bmatrix} \dot{x} \\ \dot{z} \end{bmatrix} = \mathcal{A} \begin{bmatrix} x \\ z \end{bmatrix} + \begin{bmatrix} 0 \\ I \end{bmatrix} r(t)$$

where  $\mathcal{A} = \begin{bmatrix} A - BF_1 & -BF_2 \\ -C & 0 \end{bmatrix}$  is Hurwitz. When  $r$  is constant, the system has a unique equilibrium point  $(\bar{x}(r), \bar{z}(r))$ , where  $C\bar{x} = r$ . Moreover, this point is exponentially stable. Hence  $x(t) \rightarrow \bar{x}$  and  $z(t) \rightarrow \bar{z}$  as  $t \rightarrow \infty$ . Consequently,  $y(t) = Cx(t)$  approaches  $C\bar{x} = r$  as  $t \rightarrow \infty$ .

(b) Suppose that  $\|\dot{r}(t)\| \leq \varepsilon$  for all  $t \geq 0$ . The equilibrium point  $(\bar{x}(r), \bar{z}(r))$  is a linear function of  $r$ . Define  $\tilde{x} = x - \bar{x}$  and  $\tilde{z} = z - \bar{z}$  to shift the equilibrium point to the origin.

$$\begin{bmatrix} \dot{\tilde{x}} \\ \dot{\tilde{z}} \end{bmatrix} = \mathcal{A} \begin{bmatrix} \tilde{x} \\ \tilde{z} \end{bmatrix}$$

Consider the Lyapunov function  $V(\tilde{x}, \tilde{z}) = \begin{bmatrix} \tilde{x} \\ \tilde{z} \end{bmatrix}^T \mathcal{P} \begin{bmatrix} \tilde{x} \\ \tilde{z} \end{bmatrix}$ , where  $\mathcal{P}$  is the solution of the Lyapunov equation  $\mathcal{P}\mathcal{A} + \mathcal{A}^T\mathcal{P} = -I$ . The function  $V$  satisfies the inequalities (9.41)–(9.44) of the text with  $c_1 = \lambda_{\min}(\mathcal{P})$ ,  $c_2 = \lambda_{\max}(\mathcal{P})$ ,  $c_3 = 1$ ,  $c_4 = 2\lambda_{\max}(\mathcal{P})$ , and  $c_5 = 0$  (since  $V$  is independent of  $r$ ). Thus, all the assumption of Theorem 9.3 are satisfied globally. Therefore, the solutions  $(\tilde{x}(t), \tilde{z}(t))$  are uniformly ultimately bounded with an ultimate bound that is proportional to  $\varepsilon$ . It follows that the norm of the tracking error is smaller than  $k\varepsilon$  for some  $k > 0$ . Moreover, if  $\dot{r}(t) \rightarrow 0$  as  $t \rightarrow \infty$ , then the tracking error tends to zero.

## 《非线性系统（第三版）》习题解答

• **9.29 (a)** Since  $(\bar{x}, \bar{z})$  is exponentially stable, for initial states sufficiently close to the equilibrium point,  $x(t) \rightarrow \bar{x}$  and  $z(t) \rightarrow \bar{z}$  as  $t \rightarrow \infty$ . Consequently,  $y(t) = h(x(t))$  approaches  $h(\bar{x}) = r$  as  $t \rightarrow \infty$ .

(b) Suppose  $\|\dot{r}(t)\|_2 \leq \varepsilon$  for all  $t \geq 0$ . It can be easily verified that all the assumptions of Lemma 9.8 are satisfied in some domain around the equilibrium point. Hence, there is a Lyapunov function that satisfies inequalities (9.41)–(9.44) of the text. Now, it can be seen that all the assumptions of Theorem 9.3 are satisfied in some domain around the equilibrium point. It follows from the theorem that for sufficiently small  $\varepsilon$ , the solutions will be uniformly ultimately bounded to a ball around the equilibrium point. The radius of this ball is proportional to  $\varepsilon$ . Hence, the norm of the tracking error is smaller than  $k\varepsilon$  for some  $k > 0$ . Moreover, if  $\dot{r}(t) \rightarrow 0$  as  $t \rightarrow \infty$ , then the tracking error tends to zero.

• **9.30** The solution of this exercise is identical to the solution of Exercise 9.29, except for taking the state vector as  $(x, z_1, z_2)$ .

• **9.31** Following the proof of Lemma 9.8, we see that

$$\|\exp[\tau A(t)]\| \leq k_1 e^{-\gamma\tau}, \forall \tau \geq 0$$

for some positive constants  $k_1$  and  $\gamma$ , and  $P(t)A(t) + A^T P(t) = -I$  has a unique positive definite solution  $P(t)$  for each  $t \geq 0$ . The matrix  $\dot{P}(t)$  satisfies

$$\dot{P}(t)A(t) + A^T(t)\dot{P}(t) = -Q(t)$$

where  $Q(t) = \dot{A}^T(t)P(t) + P(t)\dot{A}(t)$ . Therefore,

$$\dot{P}(t) = \int_0^\infty [e^{\tau A(t)}]^T Q(t) [e^{\tau A(t)}] d\tau$$

$$\|\dot{P}(t)\| \leq \|Q(t)\| \int_0^\infty k_1^2 e^{-2\gamma\tau} d\tau \leq k_2 \|\dot{A}(t)\|$$

Let  $V(t, x) = x^T P(t)x$ . Then

$$\begin{aligned} \dot{V} &= x^T [P(t)A(t) + A^T(t)P(t)]x + x^T \dot{P}(t)x \\ &= -x^T x + x^T \dot{P}(t)x \leq -c_1 V + c_2 \|\dot{A}(t)\| V \end{aligned}$$

Using the comparison lemma, we obtain

$$V(t, x(t)) \leq V(t_0, x(t_0)) \exp \left[ \int_{t_0}^t (-c_1 + c_2 \|\dot{A}(\tau)\|) d\tau \right]$$

By Cauchy-Schwartz inequality, we have

$$\int_{t_0}^t \|\dot{A}(\tau)\| d\tau \leq \left( \int_{t_0}^t \|\dot{A}(\tau)\|^2 d\tau \right)^{1/2} \sqrt{t - t_0} \leq \sqrt{\rho(t - t_0)}$$

Thus

$$V(t, x(t)) \leq V(t_0, x(t_0)) \exp \left[ -c_1(t - t_0) + c_2 \sqrt{\rho(t - t_0)} \right] \leq c_3 e^{-c_4(t - t_0)} V(t_0, x(t_0))$$

which shows that the origin of  $\dot{x} = A(t)x$  is exponentially stable.



## 《非线性系统（第三版）》习题解答

# Chapter 10

• **10.1**  $\delta(\varepsilon) = O(\varepsilon) \Rightarrow |\delta(\varepsilon)| \leq k|\varepsilon|$ , for  $|\varepsilon| < c$ . Thus,  $|\delta(\varepsilon)| \leq k\sqrt{c}\sqrt{\varepsilon} \stackrel{\text{def}}{=} k_1\sqrt{\varepsilon}$ , for  $|\varepsilon| < c$ . Thus,  $\delta(\varepsilon)$  is  $O(\sqrt{\varepsilon})$ . It is not  $O(|\varepsilon|^{\frac{3}{2}})$ .

• **10.2** The answer is no. If there was such  $N$ , then

$$\varepsilon^{\frac{1}{N}} \leq k\varepsilon^N \Rightarrow 1 \leq k^N \varepsilon^{nN}$$

The second inequality is impossible since  $\varepsilon^{nN} \rightarrow 0$  as  $\varepsilon \rightarrow 0$ .

• **10.3 (a)** Set  $\varepsilon = 0$ .

$$\begin{aligned} \dot{x}_{10} &= -0.2x_{10} + \frac{\pi}{4} - \tan^{-1} x_{10}, & x_{10}(0) &= \eta_1 \\ \dot{x}_{20} &= -0.2x_{20} + \frac{\pi}{4} - \tan^{-1} x_{20}, & x_{20}(0) &= \eta_2 \end{aligned}$$

(b) Substitute  $x_1 = x_{10} + \varepsilon x_{11} + \dots$ , and  $x_2 = x_{20} + \varepsilon x_{21} + \dots$  in the state equations and match the coefficients of  $\varepsilon$ . For the first equation we have

$$\begin{aligned} \dot{x}_{10} + \varepsilon \dot{x}_{11} + \dots &= -(0.2 + \varepsilon)(x_{10} + \varepsilon x_{11} + \dots) + \frac{\pi}{4} - \tan^{-1}(x_{10} + \varepsilon x_{11} + \dots) + \varepsilon \tan^{-1}(x_{20} + \varepsilon x_{21} + \dots) \\ &= -0.2x_{10} + \varepsilon(-x_{10} - 0.2x_{11} + \dots) + \frac{\pi}{4} - \tan^{-1} x_{10} - \frac{\varepsilon}{1+x_{10}^2} x_{11} + \dots + \varepsilon \tan^{-1} x_{20} + \dots \end{aligned}$$

Matching coefficients of  $\varepsilon$ , we obtain

$$\dot{x}_{11} = -\left(0.2 + \frac{1}{1+x_{10}^2}\right) x_{11} - x_{10} + \tan^{-1} x_{20}, \quad x_{11}(0) = 0$$

Similarly

$$\dot{x}_{21} = -\left(0.2 + \frac{1}{1+x_{20}^2}\right) x_{21} - x_{20} + \tan^{-1} x_{10}, \quad x_{21}(0) = 0$$

(c) The nominal system has a unique equilibrium point  $(p, p)$ , where  $p$  satisfies the equation  $0.2p + \tan^{-1} p = \pi/4$ . Linearization at this point yields the matrix

$$\left. \frac{\partial f}{\partial x} \right|_{(p,p)} = \begin{bmatrix} -0.2 - \frac{1}{1+p^2} & 0 \\ 0 & -0.2 - \frac{1}{1+p^2} \end{bmatrix}$$

The equilibrium point  $(p, p)$  is exponentially stable. Hence, Theorem 10.2 applies and we can conclude that there is a neighborhood of  $(p, p)$  such that for all initial states in that neighborhood, the approximation is valid on the infinite time interval.

(d) Write the equation for  $x_{10}$ ,  $x_{20}$ ,  $x_{11}$ , and  $x_{21}$  as four simultaneous autonomous equations and solve using a computer program. The simulation results are shown in Figure 10.1.

## 《非线性系统（第三版）》习题解答

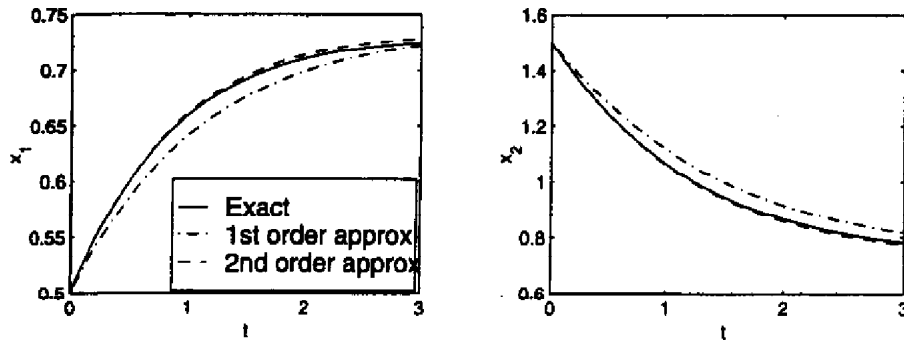

Figure 10.1: Exercise 10.3.

• 10.4 (a)

$$\begin{aligned} \dot{x}_{10} &= x_{20}, & x_{10}(0) &= \eta_1 \\ \dot{x}_{20} &= -x_{10} - x_{20}, & x_{20}(0) &= \eta_2 \end{aligned}$$

(b)

$$\begin{aligned} \dot{x}_{11} &= x_{21}, & x_{11}(0) &= 0 \\ \dot{x}_{21} &= -x_{11} - x_{21} + x_{10}^3, & x_{21}(0) &= 0 \end{aligned}$$

(c) The nominal system is a linear one with a Hurwitz matrix. Hence, the origin is exponentially stable and Theorem 10.2 applies.

(d) The simulation results are shown in Figure 10.2.

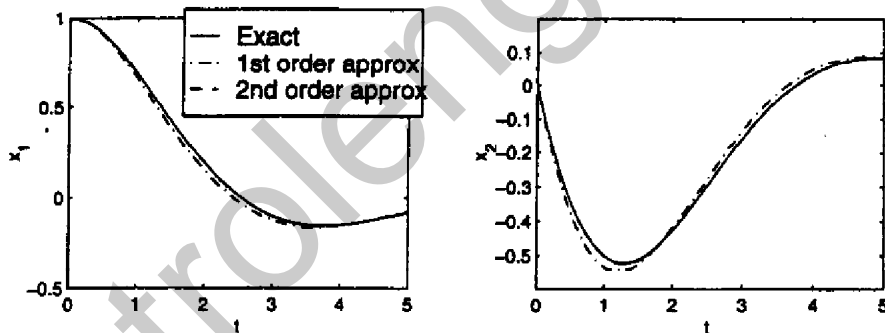

Figure 10.2: Exercise 10.4.

• 10.5 (a)

$$\begin{aligned} \dot{x}_{10} &= -x_{10} + x_{20}, & x_{10}(0) &= \eta_1 \\ \dot{x}_{20} &= -x_{20} - \frac{1}{3}x_{20}^3, & x_{20}(0) &= \eta_2 \end{aligned}$$

(b)

$$\begin{aligned} \dot{x}_{11} &= -x_{11} + x_{21}, & x_{11}(0) &= 0 \\ \dot{x}_{21} &= x_{10} - x_{21} - x_{20}^2 x_{21}, & x_{21}(0) &= 0 \end{aligned}$$

(c) The nominal system has a unique equilibrium point at the origin. The Jacobian matrix  $\left. \frac{\partial f}{\partial z} \right|_{(0,0)} =$

$\begin{bmatrix} -1 & 1 \\ 0 & -1 \end{bmatrix}$  is Hurwitz. Hence, the origin is exponentially stable and Theorem 10.2 applies.

(d) The simulation results are shown in Figure 10.3. Note that  $x_{20}(t) \equiv 0$ .

## 《非线性系统（第三版）》习题解答

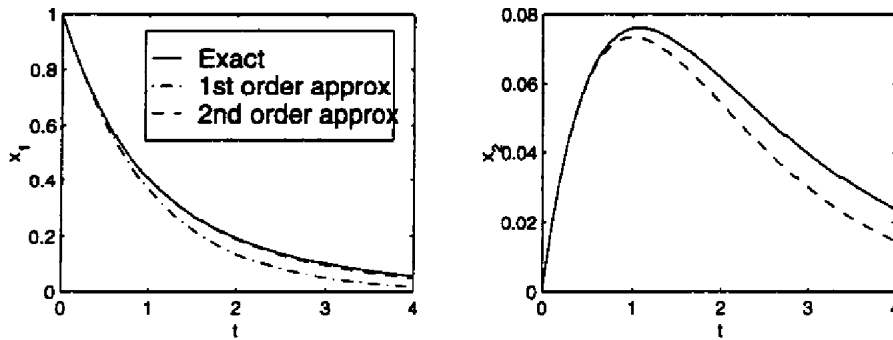

Figure 10.3: Exercise 10.5.

• 10.6 (a)

$$\begin{aligned} \dot{x}_{10} &= x_{10} - x_{10}^2, & x_{10}(0) &= \eta_1 \\ \dot{x}_{20} &= 2x_{20} - x_{20}^2, & x_{20}(0) &= \eta_2 \end{aligned}$$

(b)

$$\begin{aligned} \dot{x}_{11} &= x_{11} - 2x_{10}x_{11} + x_{10}x_{20}, & x_{11}(0) &= 0 \\ \dot{x}_{21} &= 2x_{21} - 2x_{20}x_{21} - x_{10}x_{20}, & x_{21}(0) &= 0 \end{aligned}$$

(c) The nominal system has four equilibrium points at  $(0, 0)$ ,  $(0, 2)$ ,  $(1, 0)$ , and  $(1, 2)$ . The Jacobian matrices at these points are

$$\left. \frac{\partial f}{\partial x} \right|_{(0,0)} = \begin{bmatrix} 1 & 0 \\ 0 & 2 \end{bmatrix}, \quad \left. \frac{\partial f}{\partial x} \right|_{(0,2)} = \begin{bmatrix} 1 & 0 \\ 0 & -2 \end{bmatrix}, \quad \left. \frac{\partial f}{\partial x} \right|_{(1,0)} = \begin{bmatrix} -1 & 0 \\ 0 & 2 \end{bmatrix}, \quad \left. \frac{\partial f}{\partial x} \right|_{(1,2)} = \begin{bmatrix} -1 & 0 \\ 0 & -2 \end{bmatrix}$$

Theorem 10.2 applies only to the equilibrium point  $(1, 2)$ .

(d) The simulation results are shown in Figure 10.4.

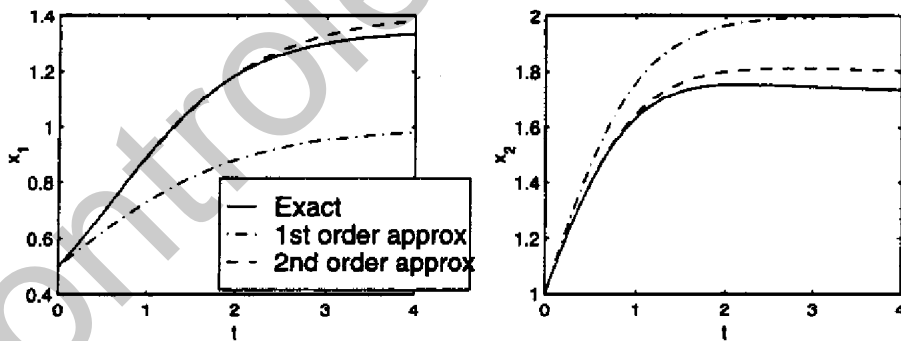

Figure 10.4: Exercise 10.6.

• 10.7 (a)

$$\begin{aligned} \dot{x}_{10} &= -x_{10} + x_{20}(1 + x_{10}), & x_{10}(0) &= \eta_1 \\ \dot{x}_{20} &= -x_{10}(x_{10} + 1), & x_{20}(0) &= \eta_2 \end{aligned}$$

(b)

$$\begin{aligned} \dot{x}_{11} &= -x_{11} + (1 + x_{10})x_{21} + x_{20}x_{11} + 1 + x_{10}^2, & x_{11}(0) &= 0 \\ \dot{x}_{21} &= -(1 + x_{10})x_{11} - x_{10}x_{11}, & x_{21}(0) &= 0 \end{aligned}$$

## 《非线性系统（第三版）》习题解答

- (c) The nominal system has a unique equilibrium point at the origin. The Jacobian matrix  $\left. \frac{\partial f}{\partial x} \right|_{(0,0)} = \begin{bmatrix} -1 & 1 \\ -1 & 0 \end{bmatrix}$  is Hurwitz. Hence, the origin is exponentially stable and Theorem 10.2 applies.
- (d) The simulation results are shown in Figure 10.5.

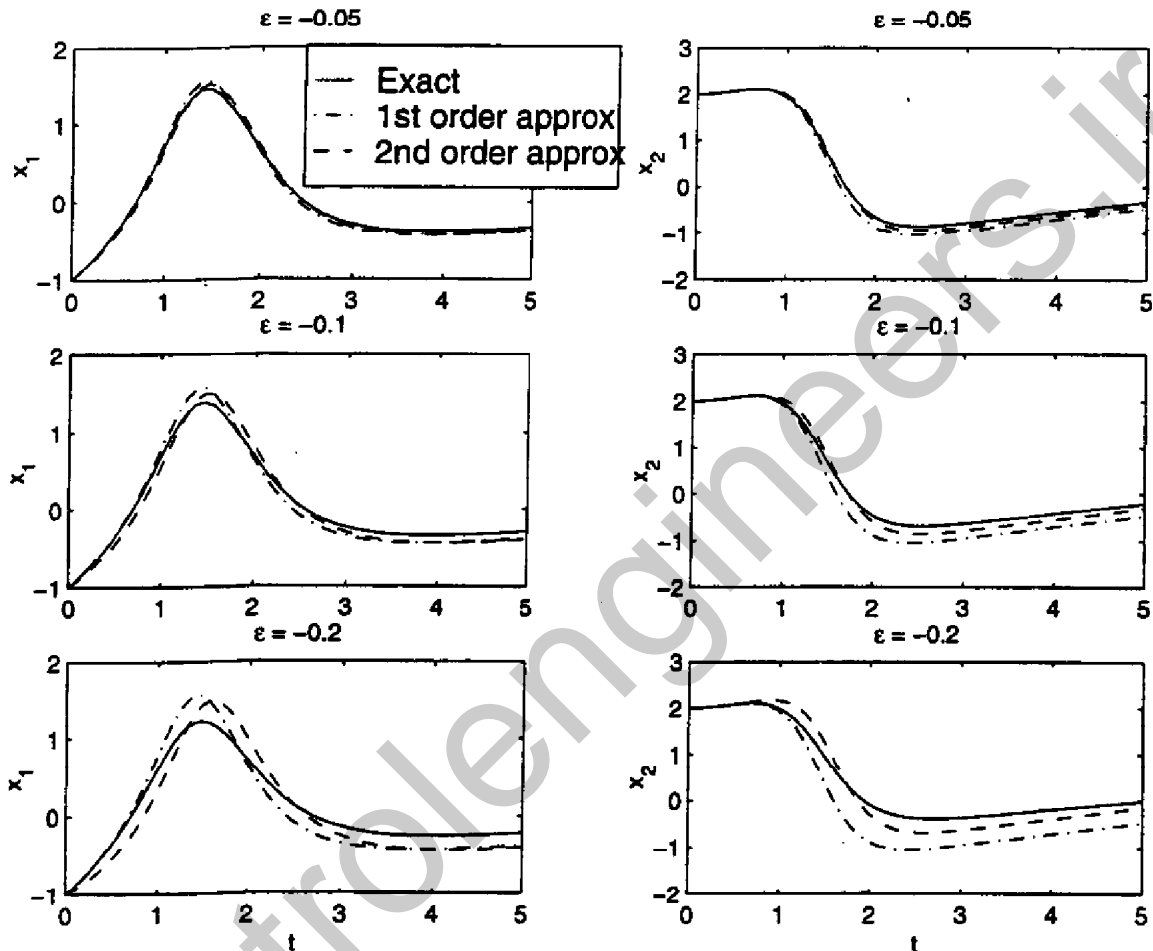

Figure 10.5: Exercise 10.7.

- 10.8 The nominal solution is given by

$$\dot{x}_{10} = -x_{10}, \quad x_{10}(0) = \eta \Rightarrow x_{10}(t) = \eta e^{-t}$$

$$\dot{x}_{20} = -x_{20}, \quad x_{20}(0) = \eta \Rightarrow x_{20}(t) = \eta e^{-t}$$

By calculating the state transition matrix as a function of  $\epsilon$ , the exact solution is determined as

$$x_1(t) = \eta e^{-t}(\cos \epsilon t + \sin \epsilon t)$$

$$x_2(t) = \eta e^{-t}(\cos \epsilon t - \sin \epsilon t)$$

Thus

$$x_1(t) - x_{10}(t) = \eta e^{-t}(-1 + \cos \epsilon t + \sin \epsilon t)$$

$$x_2(t) - x_{20}(t) = \eta e^{-t}(-1 + \cos \epsilon t - \sin \epsilon t)$$

## 《非线性系统（第三版）》习题解答

It can be easily seen that  $|1 - \cos \varepsilon t| \leq \varepsilon t$  and  $|\sin \varepsilon t| \leq \varepsilon t$ . It can be also seen that  $te^{-t} \leq 1/e$  for all  $t \geq 0$ . Thus

$$|x_1(t) - x_{10}(t)| \leq \frac{2\eta}{e}\varepsilon, \quad |x_2(t) - x_{20}(t)| \leq \frac{2\eta}{e}\varepsilon$$

These error bounds are consistent with Theorems 10.1 and 10.2. They confirm that the approximation error is bounded by  $k\varepsilon$  for some constant  $k$ . Notice, however, that the constant  $k$  depends on the initial state of the system. Thus for this quantity to be  $O(\varepsilon)$ , the initial states should be  $O(1)$ ; that is, they should be uniformly bounded as  $\varepsilon \rightarrow 0$ . When we have  $\varepsilon = 0.1$  and  $\eta = 1$ , we should expect the error to be indeed of the order of 0.1. But when  $\varepsilon = 0.1$  and  $\eta = 10$ , then actually  $\eta = O(1/\varepsilon)$  and we should not expect the error to be of the order of 0.1, as we can see in the current case from the explicit error bounds. Numerical calculations will confirm these observations. The point of this example is to illustrate that when we use the perturbation method to approximate the solution of a differential equation for some small value of  $\varepsilon$ , then that value puts a limit on the magnitude of the initial conditions.

• 10.9 (1)

$$f_{av}(x) = \frac{1}{\pi} \int_0^\pi (x - x^2) \sin^2 t \, dt = \frac{1}{\pi} \int_0^\pi \sin^2 t \, dt (x - x^2) = \frac{1}{2}(x - x^2)$$

The average system  $\dot{x} = \frac{1}{2}\varepsilon(x - x^2)$  has equilibrium points at  $x = 0$  and  $x = 1$ . The Jacobian function at these points are  $\varepsilon/2$  and  $-\varepsilon/2$ . Thus, the equilibrium point  $x = 1$  is exponentially stable. By Theorem 10.4, we conclude that, for sufficiently small  $\varepsilon$ , the system has an exponentially stable periodic solution of period  $\pi$  in an  $O(\varepsilon)$  neighborhood of  $x = 1$ . However,  $x = 1$  is an equilibrium point of the original system. Thus, the periodic solution is the trivial solution  $x(t) \equiv 1$ , and the equilibrium point  $x = 1$  is exponentially stable for sufficiently small  $\varepsilon$ . Moreover, for initial states sufficiently near  $x = 1$ ,  $x(t, \varepsilon) = x_{av}(t, \varepsilon) + O(\varepsilon)$  for all  $t \geq 0$ .

(2)

$$f_{av}(x) = \frac{1}{\pi} \int_0^\pi (x \cos^2 t - \frac{1}{2}x^2) \, dt = \frac{1}{2}(x - x^2)$$

This is the same average function as part (1). The rest of the solution is similar to part (1), except that in the current case the periodic solution is nontrivial.

(3)

$$f_{av}(x) = \frac{1}{\pi} \int_0^\pi (-x + \cos^2 t) \, dt = -x + \frac{1}{2}$$

The average system  $\dot{x} = -\varepsilon(x - \frac{1}{2})$  has an equilibrium point at  $x = \frac{1}{2}$  which is exponentially stable. By Theorem 10.4, we conclude that, for sufficiently small  $\varepsilon$ , the system has an exponentially stable periodic solution of period  $\pi$  in an  $O(\varepsilon)$  neighborhood of  $x = \frac{1}{2}$ . Moreover, for initial states sufficiently near  $x = \frac{1}{2}$ ,  $x(t, \varepsilon) = x_{av}(t, \varepsilon) + O(\varepsilon)$  for all  $t \geq 0$ .

(4)

$$f_{av}(x) = \frac{1}{2\pi} \int_0^{2\pi} (-x \cos t) \, dt = 0$$

The average system is  $\dot{x} = 0$ . We can only conclude that

$$x(t, \varepsilon) = x_{av}(t, \varepsilon) + O(\varepsilon) = x(0) + O(\varepsilon), \quad \forall t \in [0, b/\varepsilon]$$

for finite  $b > 0$ .

• 10.10 (1)

$$f_{av}(x) = \frac{1}{2\pi} \int_0^{2\pi} \begin{bmatrix} x_2 \\ -(1 + 2 \sin t)x_2 - (1 + \cos t) \sin x_1 \end{bmatrix} dt = \begin{bmatrix} x_2 \\ -x_2 - \sin x_1 \end{bmatrix}$$

## 《非线性系统（第三版）》习题解答

The average system has an equilibrium point at the origin. Linearization at the origin yields  $\left. \frac{\partial f_{av}}{\partial x} \right|_{x=0} = \begin{bmatrix} 0 & 1 \\ -1 & -1 \end{bmatrix}$ , which is Hurwitz. Thus, the origin of the average system is exponentially stable. It follows that, for sufficiently small  $\varepsilon$ , the original system has a unique exponentially stable periodic solution in the neighborhood of the origin. But the origin is an equilibrium point of the original system. Hence, the periodic solution is the trivial solution, which shows that the origin is exponentially stable.

(2)

$$f_{av}(x) = \frac{1}{2\pi} \int_0^{2\pi} \begin{bmatrix} (-1 + 1.5 \cos^2 t)x_1 + (1 - 1.5 \sin t \cos t)x_2 \\ (-1 - 1.5 \sin t \cos t)x_1 + (-1 + 1.5 \sin^2 t)x_2 \end{bmatrix} dt = \begin{bmatrix} -\frac{1}{4} & 1 \\ -1 & -\frac{1}{4} \end{bmatrix} \begin{bmatrix} x_1 \\ x_2 \end{bmatrix}$$

The matrix on the right-hand side is Hurwitz. Hence, the origin of the average system is exponentially stable. Noting that the origin is also an equilibrium point of the original system, we conclude, as in part (1), that the origin is exponentially stable for sufficiently small  $\varepsilon$ .

(3) View the given system as a perturbation of the system

$$\dot{x} = \varepsilon(-x \sin^2 t + x^2 \sin t)$$

Apply the averaging method to this system.

$$f_{av}(x) = \frac{1}{2\pi} \int_0^{2\pi} [-x \sin^2 t + x^2 \sin t] dt = -\frac{1}{2}x$$

The matrix on the right-hand side is Hurwitz. Hence, the origin of the average system is exponentially stable. Noting that the origin is also an equilibrium point of the original system, we conclude, as in part (1), that the origin is exponentially stable for sufficiently small  $\varepsilon$ . Since the perturbation term satisfies  $|\varepsilon x e^{-t}| \leq \varepsilon |x| e^{-t}$  and  $e^{-t} \rightarrow 0$  as  $t \rightarrow \infty$ , we conclude from the second case of Lemma 9.5 that the origin of the given system is exponentially stable for sufficiently small  $\varepsilon$ .

• **10.11** View the system as a perturbation of the system treated in Exercise 10(2), with  $e^{-t}$  as the perturbation term. We saw in Exercise 10(2) that the origin of the nominal system is exponentially stable for sufficiently small  $\varepsilon$ . Since the system is linear, it is globally exponentially stable. From part (3) of Lemma 9.6, we conclude that  $x(t)$  tends to zero as  $t$  tends to infinity.

• **10.12 (a)** Let  $A = MJM^{-1}$ , where  $J$  is the real Jordan form of  $A$ . Then,  $\exp(At) = M \exp(Jt)M^{-1}$  and  $\exp(-At) = M \exp(-Jt)M^{-1}$ . Since  $A$  has only simple eigenvalues on the imaginary axis,  $\exp(Jt)$  and  $\exp(-Jt)$  are formed of sinusoidal functions of  $t$ . Thus they are bounded, which implies that  $\exp(At)$  and  $\exp(-At)$  are bounded for all  $t \geq 0$ .

(b)

$$\dot{x} = -A \exp(-At)y + \exp(-At)[Ay + \varepsilon g(t, y, \varepsilon)] = \varepsilon \exp(-At)g(t, \exp(At)x, \varepsilon) \stackrel{\text{def}}{=} \varepsilon f(t, x, \varepsilon)$$

• **10.13** Let  $z_1 = y$  and  $z_2 = \dot{y}$ . Then

$$\dot{z} = \begin{bmatrix} 0 & 1 \\ -1 & 0 \end{bmatrix} z + \varepsilon \begin{bmatrix} 0 \\ -2z_1 \cos 2t \end{bmatrix} \stackrel{\text{def}}{=} Az + \varepsilon g(t, z)$$

Use the change of variables  $z = \exp(At)x$  to transform the system into  $\dot{x} = \varepsilon f(t, x)$ , where

$$\begin{aligned} f(t, x) &= \exp(-At)g(t, \exp(At)x) = \begin{bmatrix} \cos t & -\sin t \\ \sin t & \cos t \end{bmatrix} \begin{bmatrix} 0 \\ -2(x_1 \cos t + x_2 \sin t) \cos 2t \end{bmatrix} \\ &= \begin{bmatrix} \frac{1}{2} \sin 4t & 2 \sin^2 t \cos 2t \\ -2 \cos^2 t \cos 2t & -\frac{1}{2} \sin 4t \end{bmatrix} x \stackrel{\text{def}}{=} F(t)x \end{aligned}$$

## 《非线性系统（第三版）》习题解答

The average system is given by  $\dot{x} = \varepsilon F_{av}x$ , where

$$F_{av} = \frac{1}{\pi} \int_0^\pi F(t) dt = \begin{bmatrix} 0 & -\frac{1}{2} \\ -\frac{1}{2} & 0 \end{bmatrix}$$

The matrix  $F_{av}$  is not Hurwitz. Thus, we can only conclude that

$$x(t, \varepsilon) = x_{av}(t, \varepsilon) + O(\varepsilon) = \exp(\varepsilon F_{av}t)x_{av}(0) + O(\varepsilon), \text{ for } t \in [0, b/\varepsilon]$$

for a finite  $b > 0$ . Transforming this expression to the original variables, we obtain

$$z(t, \varepsilon) = \exp(At) \exp(\varepsilon F_{av}t)z(0) + O(\varepsilon), \text{ for } t \in [0, b/\varepsilon]$$

• 10.14 Let  $z_1 = y$  and  $z_2 = \dot{y}$ . Then

$$\dot{z} = \begin{bmatrix} 0 & 1 \\ -1 & 0 \end{bmatrix} z + \varepsilon \begin{bmatrix} 0 \\ 8z_2^2 \cos t \end{bmatrix} \stackrel{\text{def}}{=} Az + \varepsilon g(t, z)$$

Use the change of variables  $z = \exp(At)x$  to transform the system into  $\dot{x} = \varepsilon f(t, x)$ , where

$$\begin{aligned} f(t, x) &= \exp(-At)g(t, \exp(At)x) = \begin{bmatrix} \cos t & -\sin t \\ \sin t & \cos t \end{bmatrix} \begin{bmatrix} 0 \\ 8(-x_1 \sin t + x_2 \cos t)^2 \cos t \end{bmatrix} \\ &= \begin{bmatrix} -8 \sin t \cos t (-x_1 \sin t + x_2 \cos t)^2 \\ 8 \cos^2 t (-x_1 \sin t + x_2 \cos t)^2 \end{bmatrix} \end{aligned}$$

The average system is given by  $\dot{x} = \varepsilon f_{av}(x)$ , where

$$f_{av}(x) = \begin{bmatrix} 2x_1x_2 \\ x_1^2 + 3x_2^2 \end{bmatrix}$$

The average system has a unique equilibrium point at the origin, but the origin is not exponentially stable as it can be seen by linearization. Thus, we can only conclude that

$$x(t, \varepsilon) = x_{av}(t, \varepsilon) + O(\varepsilon), \text{ for } t \in [0, b/\varepsilon]$$

for a finite  $b > 0$ . Transforming this expression to the original variables, we obtain

$$z(t, \varepsilon) = \exp(At)x_{av}(t, \varepsilon) + O(\varepsilon), \text{ for } t \in [0, b/\varepsilon]$$

• 10.15 (1)  $g(y, \dot{y}) = -\dot{y}(1 - y^2)$ .

$$f_{av}(r) = \frac{1}{2\pi} \int_0^{2\pi} [-r \cos \phi (1 - r^2 \sin^2 \phi) \cos \phi] d\phi = -\frac{1}{2}r + \frac{1}{8}r^3$$

The average system  $\frac{dr}{d\phi} = \varepsilon f_{av}(r)$  has equilibrium points at  $r = 0$  and  $r = 2$ .

$$\left. \frac{df_{av}}{dr} \right|_{r=0} = -\frac{1}{2}, \quad \left. \frac{df_{av}}{dr} \right|_{r=2} = 1$$

The equilibrium point  $r = 0$  is exponentially stable. Noting that  $r = 0$  is also an equilibrium point of the system

$$\frac{dr}{d\phi} = \varepsilon f(\phi, r, \varepsilon), \quad \text{where } f = \frac{g(\cdot, \cdot) \cos \phi}{1 - (\varepsilon/r)g(\cdot, \cdot) \sin \phi}$$

we conclude that, for sufficiently small  $\varepsilon$ ,  $r = 0$  is an exponentially stable equilibrium point of the foregoing system. Noting further that  $\phi = 1 + O(\varepsilon)$ , we can carry this conclusion over to the second-order system

## 《非线性系统（第三版）》习题解答

$\dot{y} + y = \varepsilon g$  and say that its origin is exponentially stable for sufficiently small  $\varepsilon$ . We can also show that there is an unstable limit cycle in an  $O(\varepsilon)$  neighborhood of  $r = 2$ . To do this, reverse the time variable in the original equation to obtain  $\dot{y} + y = \varepsilon \dot{y}(1 - y^2)$ , which is the Van der Pol oscillator studied in Example 10.11. Since Van der Pol oscillator has a stable limit cycle near  $r = 2$ , the current system has an unstable limit cycle near  $r = 2$ . The same conclusion is also obvious from the foregoing analysis since reversing time has the effect of reversing the independent variable of the average system.

(2)  $g(y, \dot{y}) = \dot{y}(1 - y^2) - y^3$ .

$$f_{av}(r) = \frac{1}{2\pi} \int_0^{2\pi} [r \cos \phi (1 - r^2 \sin^2 \phi) - r^3 \sin^3 \phi] \cos \phi \, d\phi = \frac{1}{2}r - \frac{1}{8}r^3$$

The average system is the same as the Van der Pol Oscillator of Example 10.11. The rest of the solution is the same as in the example.

(3)  $g(y, \dot{y}) = -[1 - (3\pi/4)|y|]\dot{y}$ .

$$f_{av}(r) = \frac{1}{2\pi} \int_0^{2\pi} \left[ -1 + \frac{3\pi}{4}r|\sin \phi| \right] r \cos^2 \phi \, d\phi = -\frac{1}{2}r + \frac{1}{2}r^2$$

The average system  $\frac{dr}{d\phi} = \varepsilon f_{av}(r)$  has equilibrium points at  $r = 0$  and  $r = 1$ .

$$\left. \frac{df_{av}}{dr} \right|_{r=0} = -\frac{1}{2}, \quad \left. \frac{df_{av}}{dr} \right|_{r=1} = \frac{1}{2}$$

The equilibrium point  $r = 0$  is exponentially stable. Similar to part (1), we can conclude that, for sufficiently small  $\varepsilon$ , the origin of the second-order system is exponentially stable. By reversing time, we can show, again as in part (1), that for sufficiently small  $\varepsilon$  there is an unstable limit cycle in an  $O(\varepsilon)$  neighborhood of  $r = 1$ .

(4)  $g(y, \dot{y}) = -[1 - (3\pi/4)|\dot{y}|]\dot{y}$ .

$$f_{av}(r) = \frac{1}{2\pi} \int_0^{2\pi} \left[ -1 + \frac{3\pi}{4}r|\cos \phi| \right] r \cos^2 \phi \, d\phi = -\frac{1}{2}r + \frac{1}{2}r^2$$

Proceed as in Case (3).

(5)  $g(y, \dot{y}) = -(\dot{y} - y^3)$ .

$$f_{av}(r) = \frac{1}{2\pi} \int_0^{2\pi} (-r \cos \phi + r^3 \sin^3 \phi) \cos \phi \, d\phi = -\frac{1}{2}r$$

The average system  $\frac{dr}{d\phi} = \varepsilon f_{av}(r)$  has one equilibrium point at  $r = 0$ . The equilibrium point is exponentially stable. Repeating the argument of part (1), we conclude that, for sufficiently small  $\varepsilon$ , the origin of the second-order system is exponentially stable.

(6)  $g(y, \dot{y}) = \dot{y}(1 - y^2 - \dot{y}^2)$ .

$$f_{av}(r) = \frac{1}{2\pi} \int_0^{2\pi} [1 - r^2 \sin^2 \phi - r^2 \cos^2 \phi] r \cos^2 \phi \, d\phi = \frac{1}{2\pi} \int_0^{2\pi} (1 - r^2)r \cos^2 \phi \, d\phi = \frac{1}{2}r(1 - r^2)$$

The average system  $\frac{dr}{d\phi} = \varepsilon f_{av}(r)$  has equilibrium points at  $r = 0$  and  $r = 1$ .

$$\left. \frac{df_{av}}{dr} \right|_{r=0} = \frac{1}{2}, \quad \left. \frac{df_{av}}{dr} \right|_{r=1} = -1$$

For sufficiently small  $\varepsilon$ , there is a stable limit cycle in an  $O(\varepsilon)$  neighborhood of  $r = 1$ .



## 《非线性系统（第三版）》习题解答

- 10.16 (a) Apply the averaging method of Section 10.5 with  $g(y, \dot{y}) = y + \dot{y}(1 - y^2 - \dot{y}^2)$ .

$$f_{av}(r) = \frac{1}{2\pi} \int_0^{2\pi} [r \sin \phi + (1 - r^2)r \cos \phi] \cos \phi \, d\phi = \frac{1}{2}(r - r^2)$$

The average system has equilibrium points at  $r = 0$  and  $r = 1$ .  $[df_{av}/dr](1) = -1$ . For sufficiently small  $\varepsilon$ , there is a stable limit cycle in an  $O(\varepsilon)$  neighborhood of  $r = 1$ .

- (b) There is a unique equilibrium point at  $x = 0$ .

$$\left. \frac{\partial f}{\partial x} \right|_{x=0} = \begin{bmatrix} 0 & 1 \\ -1 + \varepsilon & \varepsilon \end{bmatrix}, \quad \lambda_{1,2} = \frac{\varepsilon \pm \sqrt{\varepsilon^2 - 4(1 - \varepsilon)}}{2}$$

For  $\varepsilon > 1$ , the equilibrium point is a saddle. Hence, there are no periodic orbits.

- 10.17 (a)

$$\begin{aligned} \ddot{y} &= (t^*)^2 \frac{d^2 y}{dt^2} = \frac{m}{ku^*} \frac{d^2 u}{dt^2} = \frac{1}{ku^*} \left\{ -ku + \lambda \left[ 1 - \alpha \left( \frac{du}{dt} \right)^2 \right] \frac{du}{dt} \right\} \\ &= -y + \frac{\lambda}{\lambda^*} \left[ 1 - \alpha \left( \frac{u^*}{t^*} \right)^2 \dot{y}^2 \right] \dot{y} = -y + \varepsilon \left( 1 - \frac{1}{3} \dot{y}^2 \right) \dot{y} \end{aligned}$$

- (b)

$$f_{av}(r) = \frac{1}{2\pi} \int_0^{2\pi} \left( r \cos \phi - \frac{1}{3} r^3 \cos^3 \phi \right) \cos \phi \, d\phi = \frac{1}{2} r - \frac{1}{8} r^3$$

Proceed similar to Example 10.11.

- (c) The phase portrait should show a stable limit cycle which approaches the circle  $r = 2$  as  $\varepsilon \rightarrow 0$ .

- (d) The simulation results are shown in Figure 10.6. It is clear that, as  $\varepsilon$  approaches zero, the stable limit cycle approaches a circle of radius two.

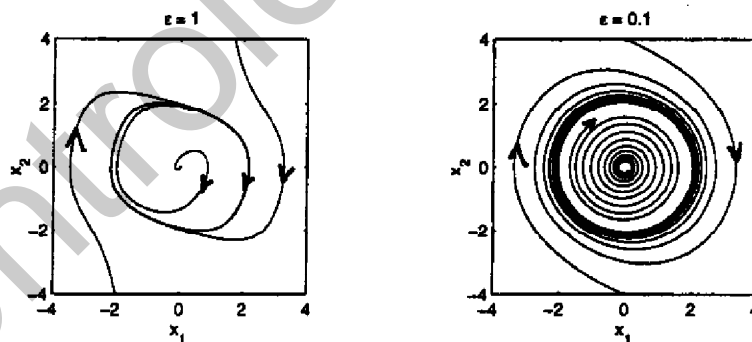

Figure 10.6: Exercise 10.17.

- 10.18 (a)

$$\frac{dx_1}{d\tau} = \varepsilon x_2, \quad \frac{dx_2}{d\tau} = \varepsilon \left[ -\frac{k}{m}(x_1 + a^2 x_1^3) - \frac{c}{m} x_2 + \frac{A}{m} \cos \tau \right]$$

- (b) The average system is given by

$$\frac{dx_{1av}}{d\tau} = \varepsilon x_{2av}, \quad \frac{dx_{2av}}{d\tau} = \varepsilon \left[ -\frac{k}{m}(x_{1av} + a^2 x_{1av}^3) - \frac{c}{m} x_{2av} \right]$$

## 《非线性系统（第三版）》习题解答

The average system has a unique equilibrium point at the origin. Linearization at the origin yields a Hurwitz matrix. Thus, for sufficiently small  $\varepsilon$  (equivalently, sufficiently large  $\omega$ ), the system has a unique exponentially stable periodic solution in an  $O(\varepsilon)$  (equivalently,  $O(1/\omega)$ ) neighborhood of the origin. The frequency of oscillation is close to  $\omega$ .

- 10.19 Start from (10.43) of the text. For  $t \leq 1/\sqrt{\eta}$ , we have

$$\begin{aligned} \eta \|w(t)\| &\leq k\sqrt{\eta}\sigma(0) + k\sigma(0) \int_0^{\sqrt{\eta}} e^{-s} s \, ds \\ &\leq k\sqrt{\eta}\sigma(0) + k\sigma(0) \left( -\sqrt{\eta}e^{-\sqrt{\eta}} + 1 - e^{-\sqrt{\eta}} \right) = k\sigma(0)(1 + \sqrt{\eta}) \left( 1 - e^{-\sqrt{\eta}} \right) \stackrel{\text{def}}{=} \alpha_1(\eta) \end{aligned}$$

It can be checked that  $\alpha_1(\eta)$  is a class  $\mathcal{K}$  function. For  $t > 1/\sqrt{\eta}$ , we have

$$\begin{aligned} \eta \|w(t)\| &\leq \frac{k}{e} \sigma \left( \frac{1}{\sqrt{\eta}} \right) + k\eta \int_0^{1/\sqrt{\eta}} e^{-\eta\lambda} \eta\lambda\sigma(\lambda) \, d\lambda + k\eta \int_{1/\sqrt{\eta}}^t e^{-\eta\lambda} \eta\lambda\sigma(\lambda) \, d\lambda \\ &\leq \frac{k}{e} \sigma \left( \frac{1}{\sqrt{\eta}} \right) + k\sigma(0) \left( -\sqrt{\eta}e^{-\sqrt{\eta}} + 1 - e^{-\sqrt{\eta}} \right) + k \int_{\sqrt{\eta}}^{\infty} e^{-s} s \, ds \sigma \left( \frac{1}{\sqrt{\eta}} \right) \\ &\leq \left( \frac{k}{e} + \sqrt{\eta} + 1 \right) \sigma \left( \frac{1}{\sqrt{\eta}} \right) + k\sigma(0) \left( 1 - e^{-\sqrt{\eta}} \right) \stackrel{\text{def}}{=} \alpha_2(\eta) \end{aligned}$$

where we have used  $te^{-t} \leq 1/e$ . It can be checked that  $\alpha_2(\eta)$  is a class  $\mathcal{K}$  function. Choose a class  $\mathcal{K}$  function  $\alpha(\eta)$  such that  $\alpha(\eta) \geq \max\{\alpha_1(\eta), \alpha_2(\eta)\}$ .

- 10.20 The average system is  $\dot{x} = \varepsilon A_{av}x$ , where

$$\begin{aligned} A_{av} &= \lim_{T \rightarrow \infty} \frac{1}{T} \int_t^{t+T} (\sin^2 \tau + \sin 1.5\tau + e^{-\tau}) \, d\tau \\ &= \lim_{T \rightarrow \infty} \frac{1}{T} \left\{ \frac{1}{2}T - \frac{1}{4}[\sin(2t+2T) - \sin 2t] - \frac{1}{1.5}[\cos(1.5t+1.5T) - \cos 1.5t] - [e^{-(t+T)} - e^{-t}] \right\} = \frac{1}{2} \end{aligned}$$

The average system is  $\dot{x} = \frac{1}{2}\varepsilon x$ . From the above limit calculation, it is not hard to see that the convergence function can be taken as  $\sigma(T) = 1/(T+1)$ . Hence, the class  $\mathcal{K}$  function  $\alpha(\eta)$  of Theorem 10.5 can be taken as  $\alpha(\eta) = k\eta$ . The origin of the average system is not exponentially stable. We can only conclude that

$$x(t, \varepsilon) = x_{av}(t, \varepsilon) + O(\varepsilon) = e^{t\varepsilon/2} x(0) + O(\varepsilon), \quad \forall t \in [0, b/\varepsilon]$$

for a finite  $b > 0$ .

- 10.21 (a) We have  $\dot{\theta} = -\varepsilon e(t)w(t) = -\varepsilon w(t)e(t)$  and  $e(t) = [\theta(t) - \theta^*]^T w(t) = \phi^T(t)w(t) = w^T(t)\phi(t)$ . Then

$$\dot{\phi} = \dot{\theta} = -\varepsilon w(t)w^T(t)\phi = \varepsilon A(t)\phi$$

where  $A(t) = -w(t)w^T(t)$ .

(b) Suppose that  $w(t)$  is bounded and smooth enough to ensure that  $A(t)$  and its derivatives up to the second order are continuous and bounded. From Example 10.13 we see that the origin of the system  $\dot{\phi} = \varepsilon A(t)\phi$  is exponentially stable for sufficiently small  $\varepsilon$  if

$$A_{av} = - \lim_{T \rightarrow \infty} \frac{1}{T} \int_t^{t+T} w(\tau)w^T(\tau) \, d\tau$$

is Hurwitz. The matrix  $A_{av}$  is negative semidefinite by construction. Hence, it is Hurwitz if and only if it is negative definite. Thus, we require that

$$\int_t^{t+T} w(\tau)w^T(\tau) \, d\tau \geq cI, \quad \forall t \geq 0$$

for some  $c > 0$ . This is a persistence of excitation condition.

## 《非线性系统（第三版）》习题解答

# Chapter 11

- 11.1 The circuit equations are

$$R_1 C_1 \dot{v}_1 = -v_1 + v_2, \quad R_2 C_2 \dot{v}_2 = \frac{R_2}{R_1} v_1 - \left(1 + \frac{R_2}{R_1}\right) v_2 + u$$

Let  $\varepsilon = C_2/C_1$  and  $R_1 = R_2 = R$ . Multiplying the second equation through by  $1/R_2 C_1$ , we can rewrite the equations as

$$\dot{v}_1 = \frac{1}{RC_1}(-v_1 + v_2), \quad \varepsilon \dot{v}_2 = \frac{1}{RC_1}(v_1 - 2v_2 + u)$$

Setting  $\varepsilon = 0$  results in the equation  $0 = v_1 - 2v_2 + u$ , which has the unique root  $v_2 = \frac{1}{2}(v_1 + u)$ . Hence, the system is in the standard singularly perturbed form.

- 11.2 The circuit equations are given above. Let  $\varepsilon = R_1/R_2$  and  $C_1 = C_2 = C$ . We can rewrite the equations as

$$\varepsilon \dot{v}_1 = \frac{1}{R_2 C}(-v_1 + v_2), \quad \varepsilon \dot{v}_2 = \frac{1}{R_2 C}[v_1 - (\varepsilon + 1)v_2 + \varepsilon u]$$

Setting  $\varepsilon = 0$  yields the equation  $-v_1 + v_2 = 0$ , whose roots  $v_2 = v_1$  are not isolated. Now, similar to Example 11.3, take  $x = \frac{1}{2}(v_1 + v_2)$ . We can take  $z$  as in the example, or simply take  $z = v_2$ . We obtain

$$\dot{x} = \frac{1}{2R_2 C}(-z + u), \quad \varepsilon \dot{z} = \frac{1}{R_2 C}[2x - (2 + \varepsilon)z + \varepsilon u]$$

Setting  $\varepsilon = 0$  yields the equation  $2x - 2z = 0$  which has a unique root  $z = x$ . Hence, the system is in the standard singularly perturbed form.

- 11.3 Recall from Section 1.2.2 that the circuit is represented by

$$\dot{x}_1 = \frac{1}{C}[-h(x_1) + x_2], \quad \dot{x}_2 = \frac{1}{L}(-x_1 - Rx_2 + u)$$

When  $L$  is small, the inductance current  $x_2$  is the candidate to be the fast variable  $z$ . Let  $x = x_1$ ,  $z = x_2$ , and  $\varepsilon = L/CR^2$ .

$$\dot{x} = \frac{1}{C}[-h(x) + z], \quad \varepsilon \dot{z} = \frac{1}{CR^2}[-x - Rz + u]$$

Setting  $\varepsilon = 0$  yields the equation  $-x - Rz + u = 0$  which has a unique root  $z = (-x + u)/R$ . Hence, the system is in the standard singularly perturbed form.

- 11.4 From the block diagram, we obtain

$$\dot{x} = z, \quad \dot{z} = -z + k[u - x - \psi(z)]$$

## 《非线性系统（第三版）》习题解答

Let  $\varepsilon = 1/k$  and multiply the second equation through by  $\varepsilon$ , to obtain

$$\dot{x} = z, \quad \varepsilon \dot{z} = -\varepsilon z + u - x - \psi(z)$$

Setting  $\varepsilon = 0$  yields the equation  $u - x - \psi(z) = 0$ . Hence, the system is in the standard singularly perturbed form provided  $\psi^{-1}(\cdot)$  is defined in some domain of interest.

• 11.5 Consider equation (11.14) of the text:

$$\frac{dy}{d\tau} = g(t, x, y + h(t, x), 0)$$

where  $(t, x) \in [0, t_1] \times D_x$  are treated as constant parameters. The equation has equilibrium at  $y = 0$ . Linearization at the origin results in the matrix  $A(t, x) = \frac{\partial g}{\partial y}(t, x, h(t, x), 0)$ . We can rewrite the equation as a perturbation of its linearization at  $y = 0$ .

$$\frac{dy}{d\tau} = A(t, x)y + \psi(t, x, y)$$

where

$$\psi(t, x, y) = \left[ \frac{\partial g}{\partial y}(t, x, \alpha y + h(t, x), 0) - \frac{\partial g}{\partial y}(t, x, h(t, x), 0) \right] y$$

for some  $0 < \alpha < 0$ . Assuming that the Jacobian matrix is Lipschitz in  $y$ , we know that there exists a constant  $k$ , independent of  $(t, x)$  such that

$$\|\psi(t, x, y)\|_2 \leq k\|y\|_2^2, \quad \forall (t, x) \in [0, t_1] \times D_x$$

The matrix  $A(t, x)$  is a bounded function in  $(t, x)$  and satisfies (11.16). Suppose further that the partial derivatives of the elements of  $A(t, x)$  with respect to  $t$  and  $x$  are bounded. Then, from Lemma 9.8, we conclude that there is a Lyapunov function  $V(t, x, y)$  that satisfies inequalities

$$c_1\|y\|_2^2 \leq V(t, x, y) \leq c_2\|y\|_2^2, \quad \frac{\partial V}{\partial y} A(t, x)y \leq -c_3\|y\|_2^2, \quad \left\| \frac{\partial V}{\partial y} \right\|_2 \leq c_4\|y\|_2$$

where the constants  $c_1$  to  $c_4$  are independent of  $(t, x)$ . The derivative of  $V$  with respect to (11.14) satisfies

$$\frac{\partial V}{\partial y} g(t, x, y + h(t, x), 0) = \frac{\partial V}{\partial y} [A(t, x)y + \psi(t, x, y)] \leq -c_3\|y\|_2^2 + c_4 k\|y\|_2^3 \leq -\frac{1}{2}c_3\|y\|_2^2$$

for  $\|y\|_2 \leq c_3/2kc_4$ . Thus,  $V(t, x)$  satisfies inequalities (11.17)–(11.18). Going from here to inequality (11.15) is the subject of the next exercise.

• 11.6 Suppose  $V$  satisfies (11.17)–(11.18). The derivative of  $V$  with respect to (11.14) is given by

$$\frac{dV}{d\tau} = \frac{\partial V}{\partial y} g \leq -c_3\|y\|_2^2 \leq -\frac{c_3}{c_2} V$$

$$\implies V(\tau) \leq e^{-\frac{c_3}{c_2}\tau} V(0) \implies \|y(\tau)\| \leq \sqrt{\frac{c_2}{c_1}} e^{-\frac{c_3}{2c_2}\tau} \|y(0)\|$$

Hence, (11.15) is satisfied with  $k = \sqrt{c_2/c_1}$  and  $\gamma = c_3/2c_2$ . To ensure that  $\|y(t)\| < \rho$  for all  $\tau$ , we restrict  $\|y(0)\|$  to  $\|y(0)\| < \rho_0 = \rho\sqrt{c_1/c_2}$ .

## 《非线性系统（第三版）》习题解答

- 11.7 (a) Setting  $\varepsilon = 0$  yields  $h(x) = x^2 + 1$ . The reduced model is

$$\dot{x} = 2x^2 + 1, \quad x(0) = \xi \Rightarrow \bar{x}(t) = \frac{1}{\sqrt{2}} \tan \left( t\sqrt{2} + \tan^{-1} \left( \xi\sqrt{2} \right) \right)$$

The boundary-layer model is

$$\frac{dy}{d\tau} = -y, \quad y(0) = \eta - (1 + \xi^2) \Rightarrow y(\tau) = [\eta - (1 + \xi^2)]e^{-\tau}$$

Thus,

$$x(t, \varepsilon) = \frac{1}{\sqrt{2}} \tan \left( t\sqrt{2} + \tan^{-1} \left( \xi\sqrt{2} \right) \right) + O(\varepsilon)$$

$$z(t, \varepsilon) = 1 + \frac{1}{2} \left[ \tan \left( t\sqrt{2} + \tan^{-1} \left( \xi\sqrt{2} \right) \right) \right]^2 + [\eta - (1 + \xi^2)]e^{-t/\varepsilon} + O(\varepsilon)$$

- (b) The simulation results are shown in Figure 11.1.

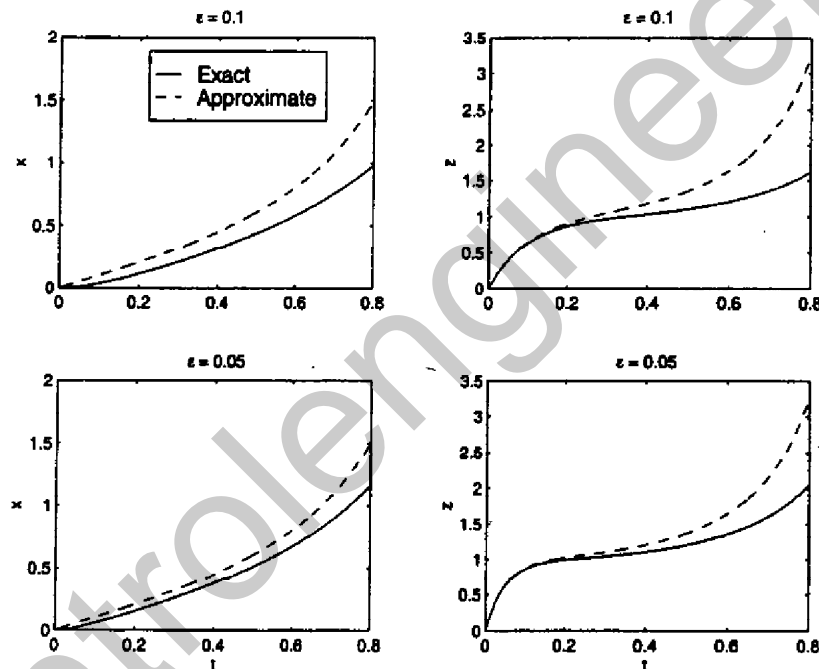

Figure 11.1: Exercise 11.7.

- 11.8 (a) Setting  $\varepsilon = 0$  yields  $h(x) = -2x$ . The reduced model is

$$\dot{x} = -x, \quad x(0) = \eta \Rightarrow \bar{x}(t) = \eta e^{-t}$$

The boundary-layer model is

$$\frac{dy}{d\tau} = -\frac{2}{\pi} \tan^{-1} \left( \frac{\pi}{2} y \right), \quad y(0) = \eta + 2\xi$$

Denote its solution by  $\hat{y}(\tau)$ . Thus,

$$x(t, \varepsilon) = \eta e^{-t} + O(\varepsilon), \quad z(t, \varepsilon) = -2\eta e^{-t} + \hat{y}(t/\varepsilon) + O(\varepsilon)$$

- (b) The simulation results are shown in Figure 11.2. As you decrease  $\varepsilon$ , the exact and approximate solutions will come closer to each other.

## 《非线性系统（第三版）》习题解答

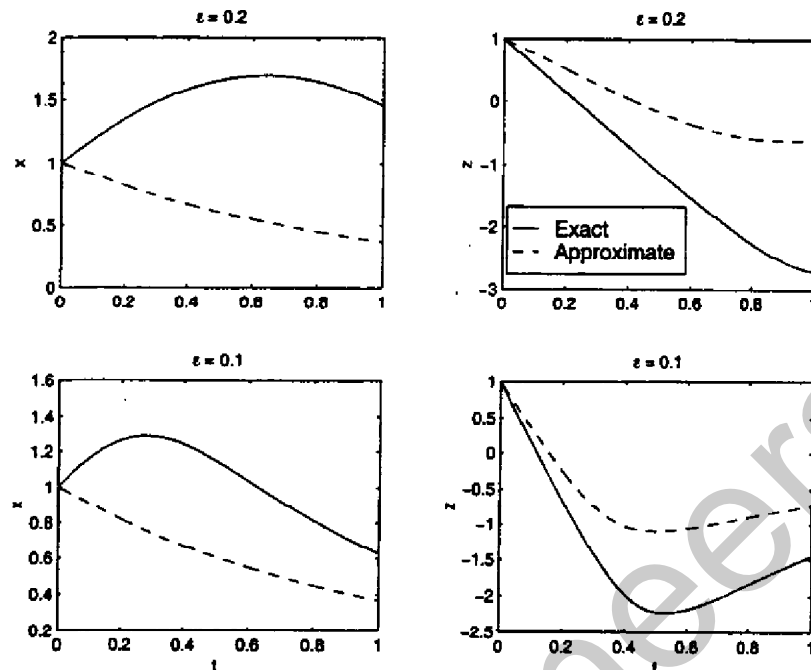

Figure 11.2: Exercise 11.8.

- **11.9** Setting  $\varepsilon = 0$  yields  $h(t, x) = \ln(1 + u(t) - x)$ , assuming that  $(1 + u(t) - x) > 0$ . The reduced model is

$$\dot{x} = \ln(1 + u(t) - x)$$

The boundary-layer model is

$$\frac{dy}{d\tau} = -(e^y - 1)(1 + u(t) - x)$$

Linearization of the boundary-layer model at  $y = 0$  results in the linear system

$$\frac{dy}{d\tau} = -(1 + u(t) - x)y$$

Assuming  $0 < c_1 \leq [1 + u(t) - x] \leq c_2 < \infty$  ensures that the origin of the boundary-layer model is exponentially stable uniformly in  $(t, x)$ .

- **11.10 (a)** Setting  $\varepsilon = 0$  yields  $0 = (z + xt)(z - 2)(z - 4)$  which has three roots  $h_1(t, x) = -xt$ ,  $h_2 = 2$ , and  $h_3 = 4$ . We assume that  $xt > 0$  is the domain of interest. Then, the three roots are isolated. Each root could give rise to a reduced model.

(b) For  $h_1(t, x) = -xt$ , the boundary-layer model is

$$\frac{dy}{d\tau} = -y(y - xt - 2)(y - xt - 4)$$

The Jacobian  $\partial g / \partial y$  at  $y = 0$  is given by

$$\left. \frac{\partial g}{\partial y} \right|_{y=0} = -(xt + 2)(xt + 4) < -8$$

## 《非线性系统（第三版）》习题解答

Hence, the origin of the boundary-layer model is exponentially stable uniformly in  $(t, x)$ . It is also clear that  $y < xt + 2$  is the region of attraction. Transformed to the  $z$  variable, the region of attraction is  $z < 2$ . For  $h_2 = 2$ , the boundary-layer model is

$$\frac{dy}{d\tau} = -y(y + xt + 2)(y - 2)$$

The Jacobian  $\partial g/\partial y$  at  $y = 0$  is given by

$$\left. \frac{\partial g}{\partial y} \right|_{y=0} = 2(2 + xt) > 4$$

Hence, the origin of the boundary-layer model is unstable. For  $h_3 = 4$ , the boundary-layer model is

$$\frac{dy}{d\tau} = -y(y + xt + 4)(y + 2)$$

The Jacobian  $\partial g/\partial y$  at  $y = 0$  is given by

$$\left. \frac{\partial g}{\partial y} \right|_{y=0} = -2(xt + 4) < -8$$

Hence, the origin of the boundary-layer model is exponentially stable uniformly in  $(t, x)$ . It is also clear that  $y > -2$  is the region of attraction. Transformed to the  $z$  variable, the region of attraction is  $z > 2$ .

(c) For  $a < 2$ ,  $z(0)$  belong to the region of attraction of the root  $z = h_1$ , while for  $a > 2$ , it belongs to the region of attraction of the third root  $z = h_3$ . Thus, for  $a < 2$ , the reduced model is

$$\dot{x} = -x, \quad x(0) = 1$$

and for  $a > 2$ , the reduced model is

$$\dot{x} = \frac{1}{4}x^2t, \quad x(0) = 1$$

An  $O(\varepsilon)$  approximation can be obtained by using expressions (11.20)–(11.21) of Tikhonov's theorem.

• 11.11 Setting  $\varepsilon = 0$  results in  $z = \sin t$ . The reduced model is  $\dot{x} = -x$  and the boundary-layer model is  $dy/d\tau = -y$ . Clearly all the assumptions of Theorem 11.2 are satisfied. Hence, the  $O(\varepsilon)$  approximation

$$x(t, \varepsilon) = e^{-t}x(0) + O(\varepsilon), \quad z(t, \varepsilon) = \sin t + e^{-t}z(0) + O(\varepsilon)$$

holds uniformly in  $t$  for all  $t \geq 0$ .

• 11.12 The manifold equation is

$$-H - x^{4/3} + \frac{4}{3}\varepsilon x^{16/3} - \varepsilon \frac{\partial H}{\partial x} x H^3 = 0$$

It can be easily checked that  $H = -x^{4/3}$  satisfies this equation.

• 11.13 The manifold equation is

$$-(H - \sin^2 x)(H - e^{\alpha x})(H - 2e^{2\alpha x}) + \varepsilon \frac{\partial H}{\partial x} x H = 0$$

At  $\varepsilon = 0$  we have three equilibrium manifolds

$$H_1 = \sin^2 x, \quad H_2 = e^{\alpha x}, \quad H_3 = 2e^{2\alpha x}$$

The Jacobian  $\partial g/\partial z$  is negative on  $H_1$  and  $H_3$  and positive on  $H_2$ . Hence,  $H_1$  and  $H_3$  are attractive.

## 《非线性系统（第三版）》习题解答

- 11.14 (a) The manifold equation is

$$A_{21}x + A_{22}H - \varepsilon \frac{\partial H}{\partial x}(A_{11}x + A_{12}H) = 0$$

Let  $H = -Lx$ .

$$[(A_{21} - A_{22}L) + \varepsilon L(A_{11} - A_{12}L)]x = 0$$

Thus, if  $L$  satisfies the equation

$$(A_{21} - A_{22}L) + \varepsilon L(A_{11} - A_{12}L) = 0$$

$z = -Lx$  will be an exact slow manifold.

- (b) Let  $\eta = z + Lx$ . Then

$$\begin{aligned} \dot{x} &= A_{11}x + A_{12}(\eta - Lx) = (A_{11} - A_{12}L)x + A_{12}\eta \\ \varepsilon \dot{\eta} &= \varepsilon \dot{z} + \varepsilon L\dot{x} \\ &= A_{21}x + A_{22}(\eta - Lx) + \varepsilon L[(A_{11} - A_{12}L)x + A_{12}\eta] \\ &= (A_{22} + \varepsilon LA_{12})\eta \end{aligned}$$

where we have used the equation satisfied by  $L$ . The system is in a block triangular form.

(c) Since the system is in block triangular form, its eigenvalues are the eigenvalues of the diagonal blocks  $(A_{11} - A_{12}L)$  and  $(A_{22} + \varepsilon LA_{12})/\varepsilon$ . Thus, there are  $n$  eigenvalues of order  $O(1)$  and  $m$  eigenvalues of order  $O(1/\varepsilon)$ .

- (d) Let  $\xi = x - \varepsilon H\eta$ . Then

$$\dot{\xi} = (A_{11} - A_{12}L)\xi + [\varepsilon(A_{11} - A_{12}L)H - H(A_{22} + \varepsilon LA_{12}) + A_{12}]\eta$$

which reduces to

$$\dot{\xi} = (A_{11} - A_{12}L)\xi$$

when  $H$  satisfies the equation

$$\varepsilon(A_{11} - A_{12}L)H - H(A_{22} + \varepsilon LA_{12}) + A_{12} = 0$$

Thus, the change of variables

$$\xi = x - \varepsilon H\eta = x - \varepsilon H(z + Lx) = (I - \varepsilon HL)x - \varepsilon Hz, \quad \eta = Lx + z$$

transforms the system into the block diagonal form

$$\begin{aligned} \dot{\xi} &= A_s(\varepsilon)\xi, \quad \text{where } A_s = A_{11} - A_{12}L \\ \varepsilon \dot{\eta} &= A_f(\varepsilon)\eta, \quad \text{where } A_f = A_{22} + \varepsilon LA_{12} \end{aligned}$$

- (e) The inverse of the foregoing transformation is given by

$$x = \xi + \varepsilon H\eta, \quad z = -Lx + (I - \varepsilon LH)\eta$$

From the first equation it is clear that the component of the fast mode  $\eta$  in  $x$  is  $O(\varepsilon)$ .

(f) Setting  $\varepsilon = 0$  in  $\dot{\xi} = A_s(\varepsilon)\xi$  gives the reduced model  $\dot{\bar{x}} = (A_{11} - A_{12}A_{22}^{-1}A_{21})\bar{x}$ . Hence,  $\xi(t) = \bar{x}(t) + O(\varepsilon)$ . Setting  $\varepsilon = 0$  in  $d\eta/d\tau = A_f(\varepsilon)\eta$  gives the boundary-layer model  $d\hat{y}/d\tau = A_{22}\hat{y}$ . Thus,  $\eta(\tau) = \hat{y}(\tau) + O(\varepsilon)$ . Therefore

$$\begin{aligned} x &= \xi + \varepsilon H\eta = \bar{x} + O(\varepsilon) \\ z &= -Lx + (I - \varepsilon LH)\eta = -A_{22}^{-1}A_{21}\bar{x} + \hat{y} + O(\varepsilon) \end{aligned}$$

where we have used  $L = A_{22}^{-1}A_{21} + O(\varepsilon)$ .



## 《非线性系统（第三版）》习题解答

- 11.15 Application of the transformation of Exercise 11.14; namely,

$$\begin{bmatrix} \mathcal{X} \\ \mathcal{Z} \end{bmatrix} = \begin{bmatrix} I - \varepsilon HL & -\varepsilon H \\ L & I \end{bmatrix} \begin{bmatrix} x \\ z \end{bmatrix}$$

results in

$$\dot{\mathcal{X}} = A_s \mathcal{X} + B_s u, \quad \varepsilon \dot{\mathcal{Z}} = A_f \mathcal{Z} + B_f u$$

where

$$\begin{aligned} A_s &= A_{11} - A_{12}L = A_0 + O(\varepsilon) \\ A_f &= A_{22} + \varepsilon LA_{12} = A_{22} + O(\varepsilon) \\ B_s &= (I - \varepsilon HL)B_1 - HB_2 = B_0 + O(\varepsilon) \\ B_f &= B_2 + \varepsilon LB_1 = B_2 + O(\varepsilon) \end{aligned}$$

Furthermore,  $x = \mathcal{X} + \varepsilon H \mathcal{Z}$ . Since  $A_{22}$  is Hurwitz, so is  $A_f$ , for sufficiently small  $\varepsilon$ . Thus,  $\mathcal{Z}(t, \varepsilon)$  is uniformly bounded for all  $t \geq 0$ . Therefore,

$$x(t, \varepsilon) - \mathcal{X}(t, \varepsilon) = O(\varepsilon), \quad \forall t \geq 0$$

(a) Application of Theorem 3.4 shows that  $\mathcal{X}(t, \varepsilon) - \bar{x}(t) = O(\varepsilon)$  on any compact time interval. This implies that  $x(t, \varepsilon) - \bar{x}(t) = O(\varepsilon)$  on any compact time interval.

(b) Let  $e = \mathcal{X} - \bar{x}$ .

$$\dot{e} = A_s \mathcal{X} + B_s u - A_0 \bar{x} - B_0 u = [A_0 + O(\varepsilon)]e + O(\varepsilon)$$

Since  $A_0$  is Hurwitz and  $e(0, \varepsilon) = O(\varepsilon)$ , we conclude from Theorem 9.1 that  $e(t, \varepsilon) = O(\varepsilon)$  for all  $t \geq 0$ . Consequently,  $x(t, \varepsilon) - \bar{x}(t) = O(\varepsilon)$  for all  $t \geq 0$ .

- 11.16 (a) Setting  $\varepsilon = 0$  yields the equation  $\tan^{-1}(1 - x_1 - z) = 0$ , which has a unique root  $z = 1 - x_1 \stackrel{\text{def}}{=} h(x)$ . The reduced model is

$$\dot{x}_1 = x_2, \quad \dot{x}_2 = -x_1 - x_2 + 1$$

The boundary-layer model is

$$\frac{dy}{d\tau} = -\tan^{-1} y$$

(b) Let  $W(y) = \frac{1}{2}y^2$  be a Lyapunov function candidate for the boundary-layer model. Then

$$\frac{dW}{dy}(-\tan^{-1} y) = -y \tan^{-1} y < 0, \quad \forall y \neq 0$$

Hence, the origin of the boundary-layer model is globally asymptotically stable. For  $|y| \leq a$ , we have

$$\frac{dW}{dy}(-\tan^{-1} y) \leq -\frac{1}{a} \tan^{-1}(a)y^2$$

which shows that the origin is exponentially stable. Of course these stability properties are uniform in  $x$  since the boundary-layer model is independent of  $x$ .

(c) Let  $\bar{x}(t)$  be the solution of the reduced model starting from initial conditions  $x_1(0) = x_2(0) = 0$ . Let  $\hat{y}(\tau)$  be the solution of the boundary-layer model starting at  $y(0) = z(0) - 1 + x_1(0) = -1$ . An  $O(\varepsilon)$  approximation can be obtained by using expressions (11.20)–(11.21) of Tikhonov's theorem. Simulation results are shown in Figure 11.3.

(d) The conditions of Theorem 11.2 are satisfied.

(e) The system has a unique equilibrium point at  $x_1 = 1, x_2 = z = 0$ . Applying a change of variables to shift the equilibrium to the origin, we can rewrite the state equation as

$$\dot{x} = Ax + B(z + Cx), \quad \varepsilon \dot{z} = -\tan^{-1}(z + Cx)$$

## 《非线性系统（第三版）》习题解答

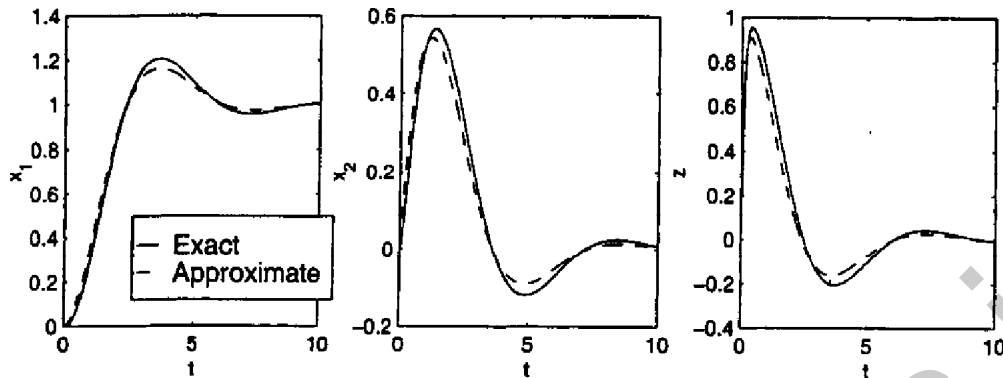

Figure 11.3: Exercise 11.16.

where

$$A = \begin{bmatrix} 0 & 1 \\ -1 & -1 \end{bmatrix}, \quad B = \begin{bmatrix} 0 \\ 1 \end{bmatrix}, \quad C = [1 \ 0]$$

Use the notation of Section 11.5. The matrix  $A$  is Hurwitz. Let  $P$  be the solution of the Lyapunov equation  $PA + A^T P = -I$ . It is given by  $P = \begin{bmatrix} 1.5 & 0.5 \\ 0.5 & 1 \end{bmatrix}$ . Let  $V(x) = x^T P x$  and  $W(y) = \frac{1}{2} y^2$ . Then

$$\frac{\partial V}{\partial x} f(x, h(x)) = -\|x\|_2^2 \Rightarrow \alpha_1 = 1, \psi_1 = \|x\|_2$$

$$\frac{\partial W}{\partial y} g(x, y + h(x)) = -y \tan^{-1} y \leq -\alpha_2 |y|^2, \quad \forall |y| \leq a, \quad \text{where } \alpha_2 = \frac{1}{a} \tan^{-1}(a), \quad \psi_2 = |y|$$

$$\frac{\partial V}{\partial x} [f(x, y + h(x)) - f(x, h(x))] = 2x^T P B y \leq 2\|PB\|_2 \|x\|_2 |y| = \sqrt{5} \|x\|_2 |y| \Rightarrow \beta_1 = \sqrt{5}$$

$$\begin{aligned} \left[ \frac{\partial W}{\partial x} - \frac{\partial W}{\partial y} \frac{\partial h}{\partial x} \right] f(x, y + h(x)) &= y C f(x, y + h(x)) = y C A x + y C B y = y C A x \\ &\leq \|CA\|_2 \|x\|_2 |y| = \|x\|_2 |y| \Rightarrow \beta_2 = 1, \gamma = 0 \end{aligned}$$

Hence, the origin is asymptotically stable for  $\varepsilon < \varepsilon^*$ , where

$$\varepsilon^* = \frac{\alpha_1 \alpha_2}{\alpha_1 \gamma + \beta_1 \beta_2} = \frac{1}{a\sqrt{5}} \tan^{-1} a$$

It is also exponentially stable (see Exercise 11.24). Based on this analysis we cannot conclude global asymptotic stability.

• **11.17 (a)** Setting  $\varepsilon = 0$  yields the equation  $x - x^2 - z = 0$ , which has the unique root  $z = x - x^2 \stackrel{\text{def}}{=} h(x)$ . The reduced model is  $\dot{x} = -x$ . The boundary-layer model is  $\frac{dy}{d\tau} = -y$ .

**(b)** The boundary-layer model is linear and independent of  $x$ . Its origin is clearly globally exponentially stable.

**(c)** Let  $\bar{x}(t)$  be the solution of the reduced model starting from the initial condition  $x(0) = 1$ . It can be verified that  $\bar{x}(t) = e^{-t}$ . Let  $\hat{y}(\tau)$  be the solution of the boundary-layer model starting at  $y(0) = z(0) - x(0) + x^2(0) = 1$ . It can be verified that  $\hat{y}(\tau) = e^{-\tau}$ . An  $O(\varepsilon)$  approximation is given by

$$x(t, \varepsilon) = e^{-t} + O(\varepsilon), \quad z(t, \varepsilon) = e^{-t} - e^{-2t} + e^{-t/\varepsilon} + O(\varepsilon)$$

## 《非线性系统（第三版）》习题解答

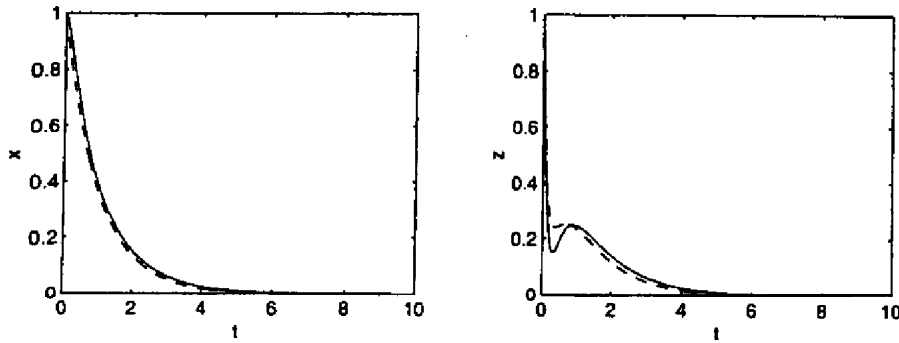

Figure 11.4: Exercise 11.17.

Simulation results for  $\varepsilon = 0.1$  are shown in Figure 11.4.

(d) The conditions of Theorem 11.2 are satisfied.

(e) The system has a unique equilibrium point at the origin. Let  $V(x) = \frac{1}{2}x^2$  and  $W(y) = \frac{1}{2}y^2$ . Then

$$\frac{\partial V}{\partial x} f(x, h(x)) = -|x|^2 \Rightarrow \alpha_1 = 1, \psi_1 = |x|$$

$$\frac{\partial W}{\partial y} g(x, y + h(x)) = -y^2, \Rightarrow \alpha_2 = 1, \psi_2 = |y|$$

$$\frac{\partial V}{\partial x} [f(x, y + h(x)) - f(x, h(x))] = xy \leq |x||y| \Rightarrow \beta_1 = 1$$

$$\begin{aligned} \left[ \frac{\partial W}{\partial x} - \frac{\partial W}{\partial y} \frac{\partial h}{\partial x} \right] f(x, y + h(x)) &= -y(1 - 2x)(-x + y) \\ &\leq (1 + 2a)|x||y| + (1 + 2a)|y|^2, \forall |x| \leq a, \Rightarrow \beta_2 = \gamma = (1 + 2a) \end{aligned}$$

Hence, the origin is asymptotically stable for  $\varepsilon < \varepsilon^* = \alpha_1 \alpha_2 / (\alpha_1 \gamma + \beta_1 \beta_2) = 1/[2(1 + 2a)]$ . It is also exponentially stable (see Exercise 11.24). Based on this analysis we cannot conclude global asymptotic stability.

• 11.18 (a) Setting  $\varepsilon = 0$  yields the equation  $-2x^{4/3} - 2z = 0$ , which has the unique root  $z = -x^{4/3} \stackrel{\text{def}}{=} h(x)$ . The reduced model is  $\dot{x} = -x^5$ . The boundary-layer model is  $\frac{dy}{d\tau} = -2y$ .

(b) The boundary-layer model is linear and independent of  $x$ . Its origin is clearly globally exponentially stable.

(c) Let  $\bar{x}(t)$  be the solution of the reduced model starting from the initial condition  $x(0) = 1$ . It can be verified that  $\bar{x}(t) = 1/(1 + 4t)^{1/4}$ . Let  $\hat{y}(\tau)$  be the solution of the boundary-layer model starting at  $y(0) = z(0) + x^{4/3}(0) = 2$ . It can be verified that  $\hat{y}(\tau) = 2e^{-2\tau}$ . An  $O(\varepsilon)$  approximation is given by

$$x(t, \varepsilon) = \frac{1}{(1 + 4t)^{1/4}} + O(\varepsilon), \quad z(t, \varepsilon) = -\frac{1}{(1 + 4t)^3} + 2e^{-2t/\varepsilon} + O(\varepsilon)$$

Simulation results for  $\varepsilon = 0.1$  are shown in Figure 11.5.

(d) The conditions of Theorem 11.2 are satisfied.

(e) The system has a unique equilibrium point at the origin. Let  $V(x) = \frac{1}{6}x^6$  and  $W(y) = \frac{1}{2}y^2$ . Then

$$\frac{\partial V}{\partial x} f(x, h(x)) = -|x|^{10} \Rightarrow \alpha_1 = 1, \psi_1 = |x|^5$$

## 《非线性系统（第三版）》习题解答

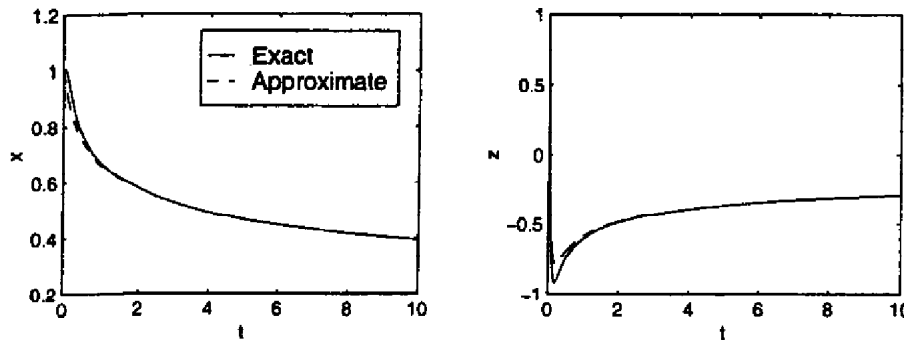

Figure 11.5: Exercise 11.18.

$$\frac{\partial W}{\partial y} g(x, y + h(x)) = -2y^2, \Rightarrow \alpha_2 = 2, \psi_2 = |y|$$

$$\begin{aligned} \frac{\partial V}{\partial x} [f(x, y + h(x)) - f(x, h(x))] &= x^6 [(y - x^{4/3})^3 + x^4] \\ &= x^6 (y^3 + 3yx^{8/3} - 3y^2x^{4/3}) \leq x^6 (y^3 + 3yx^{8/3}) \\ &\leq \beta_1 \psi_1 \psi_2 \end{aligned}$$

$$\begin{aligned} \left[ \frac{\partial W}{\partial x} - \frac{\partial W}{\partial y} \frac{\partial h}{\partial x} \right] f(x, y + h(x)) &= y \left( \frac{4}{3} x^{1/3} \right) x (y - x^{4/3})^3 \\ &= -\frac{4}{3} x^{1/3} y x^5 + \frac{4}{3} y^2 x^{4/3} (y^2 + 3x^{8/3} - 3yx^{4/3}) \\ &\leq \beta_2 \psi_1 \psi_2 + \gamma \psi_2^2 \end{aligned}$$

where the last two inequalities hold on compact sets. For example, on the set  $\{|x| \leq a, |y| \leq b\}$ , the constants  $\beta_1$ ,  $\beta_2$  and  $\gamma$  are given by

$$\beta_1 = a(b^2 + 3a^{8/3}), \quad \beta_2 = \frac{4}{3} a^{1/3}, \quad \frac{4}{3} a^{4/3} (b^2 + 3a^{8/3} + 3ba^{4/3})$$

Hence, the origin is asymptotically stable for  $\varepsilon < \varepsilon^* = \alpha_1 \alpha_2 / (\alpha_1 \gamma + \beta_1 \beta_2)$ . The Lyapunov functions  $V$  and  $W$  do not satisfy the exponential stability conditions of Exercise 11.24. Linearization at the origin yields the matrix  $\begin{bmatrix} 0 & 0 \\ 0 & -2/\varepsilon \end{bmatrix}$  which is not Hurwitz. Hence, the origin is not exponentially stable. Based on this analysis we cannot conclude global asymptotic stability.

• **11.19 (a)** Setting  $\varepsilon = 0$  yields the equation  $-z - x = 0$ , which has the unique root  $z = -x \stackrel{\text{def}}{=} h(x)$ . The reduced model is  $\dot{x} = -x^3 - \tan^{-1} x$ . The boundary-layer model is  $\frac{dy}{d\tau} = -y$ .

(b) The boundary-layer model is linear and independent of  $x$ . Its origin is clearly globally exponentially stable.

(c) Let  $\bar{x}(t)$  be the solution of the reduced model starting from the initial condition  $x(0) = -1$ . Let  $\hat{y}(\tau)$  be the solution of the boundary-layer model starting at  $y(0) = z(0) + x(0) = 1$ . An  $O(\varepsilon)$  approximation can be obtained by using expressions (11.20)–(11.21) of Tikhonov's theorem. Simulation results for  $\varepsilon = 0.1$  are shown in Figure 11.6.

(d) The conditions of Theorem 11.2 are satisfied.

(e) The system has a unique equilibrium point at the origin. Let  $V(x) = \int_0^x (y^3 + \tan^{-1} y) dy$  and  $W(y) = \frac{1}{2} y^2$ . Then

$$\frac{\partial V}{\partial x} f(x, h(x)) = -(x^3 + \tan^{-1} x)^2 \Rightarrow \alpha_1 = 1, \psi_1 = |x^3 + \tan^{-1} x|$$

## 《非线性系统（第三版）》习题解答

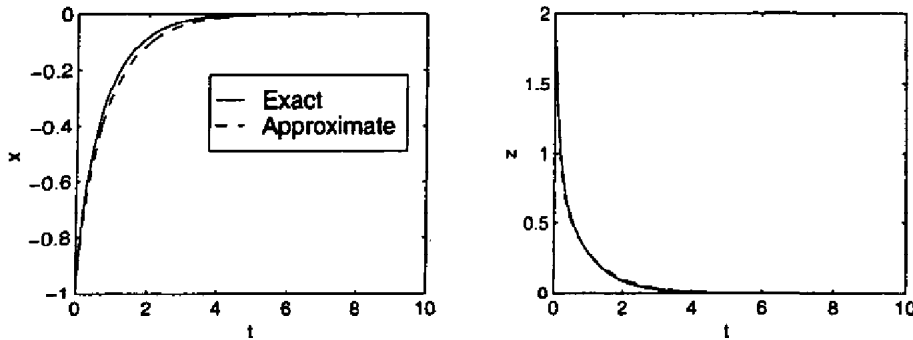

Figure 11.6: Exercise 11.19.

$$\frac{\partial W}{\partial y} g(x, y + h(x)) = -y^2, \Rightarrow \alpha_2 = 1, \psi_2 = |y|$$

$$\begin{aligned} \frac{\partial V}{\partial x} [f(x, y + h(x)) - f(x, h(x))] &= (x^3 + \tan^{-1} x) [\tan^{-1}(x) - \tan^{-1}(x - y)] \\ &\leq \psi_1 \psi_2 \Rightarrow \beta_1 = 1 \end{aligned}$$

$$\begin{aligned} \left[ \frac{\partial W}{\partial x} - \frac{\partial W}{\partial y} \frac{\partial h}{\partial x} \right] f(x, y + h(x)) &= y [-x^3 + \tan^{-1}(y - x)] \\ &= y [-x^3 - \tan^{-1} x + \tan^{-1} x - \tan^{-1}(x - y)] \\ &\leq \psi_1 \psi_2 + \psi_2^2 \Rightarrow \beta_2 = \gamma = 1 \end{aligned}$$

where all inequalities hold globally. Hence, the origin is globally asymptotically stable for  $\varepsilon < \varepsilon^* = \frac{1}{2}$ . The Lyapunov functions  $V$  and  $W$  do not satisfy the exponential stability conditions of Exercise 11.24. Linearization at the origin yields a Hurwitz matrix. Hence, the origin is exponentially stable.

• 11.20 (a) Setting  $\varepsilon = 0$  yields the equations

$$0 = z_1, \quad 0 = -z_2 - (x + z_1 + xz_1)$$

Thus,  $h(x) = \begin{bmatrix} 0 \\ -x \end{bmatrix}$ . The reduced model is  $\dot{x} = -2x$ . The boundary-layer model is

$$\frac{dy}{d\tau} = A(x)y, \quad A(x) = \begin{bmatrix} -1 & 0 \\ -(1+x) & -1 \end{bmatrix}$$

(b) The condition (11.16) is satisfied on any compact set  $B_r$ . Therefore, the boundary-layer model is exponentially stable, uniformly in  $x$ , for all  $x \in B_r$ .

(c) Let  $\bar{x}(t)$  be the solution of the reduced model starting from the initial condition  $x(0) = 1$ . Let  $\hat{y}(\tau)$  be the solution of the boundary-layer model starting at  $y(0) = \begin{bmatrix} z_1(0) \\ z_2(0) + x(0) \end{bmatrix} = \begin{bmatrix} 1 \\ 2 \end{bmatrix}$ . An  $O(\varepsilon)$  approximation can be obtained by using expressions (11.20)–(11.21) of Tikhonov's theorem. Simulation results for  $\varepsilon = 0.1$  are shown in Figure 11.7.

(d) The conditions of Theorem 11.2 are satisfied.

(e) The system has a unique equilibrium point at the origin. By linearization, it can be shown that the

《非线性系统（第三版）》习题解答

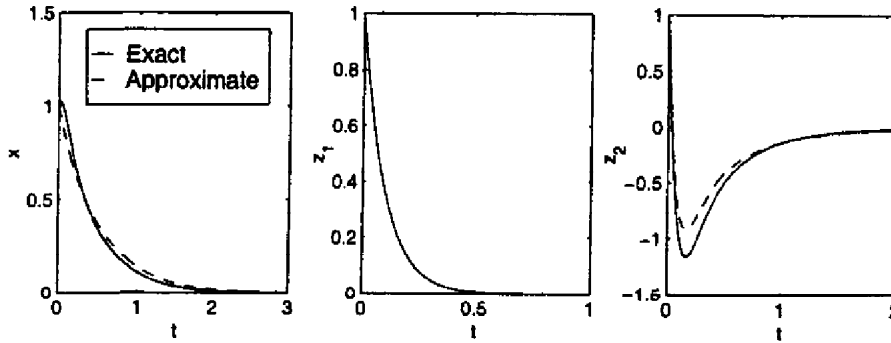

Figure 11.7: Exercise 11.20.

origin of the reduced system is exponentially stable and the origin of the boundary-layer system is exponentially stable uniformly in  $x$  on any compact set of  $x$ . It follows from Theorem 11.4 that the origin of the full system is exponentially stable for sufficiently small  $\varepsilon$ . An upper bound  $\varepsilon^*$  can be calculated by using the Lyapunov functions  $V(x) = \frac{1}{2}x^2$  and  $W(x, y) = y^T P(x)y$  where  $P(x)$  is the solution of the Lyapunov equation  $P(x)A(x) + A^T(x)P(x) = -I$ .

• 11.21 (a) The equilibrium points satisfy the equations

$$U = R_f I_f, \quad V_a = c_1 I_f \Omega + R_a I_a, \quad 0 = c_2 I_f I_a - c_3 \Omega$$

From the first equation, we obtain  $I_f = U/R_f$ . Substituting for  $\Omega$  from the second equation into the third one, we obtain

$$\left( c_3 R_a + \frac{c_1 c_2 U^2}{R_f^2} \right) I_a = c_3 V_a$$

This equation has the unique root

$$I_a = \frac{c_3 V_a}{c_3 R_a + c_1 c_2 U^2 / R_f^2} \Rightarrow \Omega = \frac{c_2 V_a U / R_f}{c_3 R_a + c_1 c_2 U^2 / R_f^2}$$

(b)

$$\begin{aligned} \dot{x}_1 &= \frac{dx_1}{dt'} = T_f \frac{dx_1}{dt} = \frac{1}{I_f} \left[ -i_f + \frac{v_f}{R_f} \right] = -x_1 + u \\ \dot{x}_2 &= T_f \frac{dx_2}{dt} = \frac{L_f}{R_f J \Omega} [c_2 I_a I_f x_1 z - c_3 \Omega x_2] = \frac{L_f c_3}{R_f J} \left[ \frac{c_2 I_a I_f}{c_3 \Omega} x_1 z - x_2 \right] = \frac{L_f c_3}{R_f J} (x_1 z - x_2) \\ \varepsilon \dot{z} &= \frac{T_a}{T_f} T_f \frac{dz}{dt} = \frac{T_a}{I_a} \frac{di_a}{dt} = \frac{1}{I_a} \left[ -I_a z - \frac{c_1 I_f \Omega}{R_a} x_1 x_2 + \frac{1}{R_a} V_a \right] \\ &= -z - \frac{c_1 I_f \Omega}{I_a R_a} x_1 x_2 + \frac{V_a}{I_a R_a} = -z - \frac{c_1 c_2 U^2}{c_3 R_a R_f^2} x_1 x_2 + \frac{V_a}{I_a R_a} \end{aligned}$$

(c) Setting  $\varepsilon = 0$  yields  $0 = -z - bx_1 x_2 + c$ . Hence,  $h(x) = -bx_1 x_2 + c$ . The reduced model is

$$\dot{x}_1 = -x_1 + u, \quad \dot{x}_2 = -ax_2 - bx_1^2 x_2 + acx_1$$

The boundary-layer model is  $\frac{dy}{d\tau} = -y$ .

(d) The boundary-layer model is linear and independent of  $x$ . Its origin is clearly globally exponentially

## 《非线性系统（第三版）》习题解答

stable.

(e) Use expressions (11.20)–(11.21) of Tikhonov's theorem.

(f) For any constant input  $u(t) \equiv u_0$ , the reduced system has a unique equilibrium point. Using Linearization, it can be shown that this point is exponentially stable. Hence, the conditions of Theorem 11.2 are satisfied.

(g) Simulation results for  $\varepsilon = 0.2$  are shown in Figure 11.8.

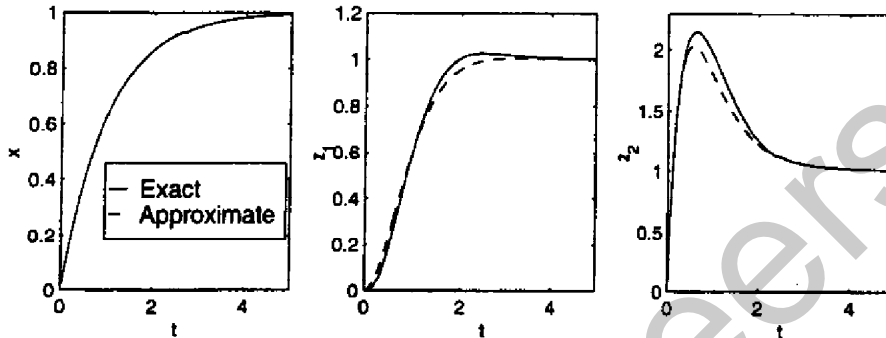

Figure 11.8: Exercise 11.21.

• 11.22 Setting  $\varepsilon = 0$  yields  $z = -x/a$ . The reduced model is  $\dot{x} = -\eta(x) - x$  and the boundary-layer model is  $dy/d\tau = -y$ . Let  $V(x) = \frac{1}{2}x^2 + \int_0^x \eta(\sigma) d\sigma$  and  $W(y) = \frac{1}{2}y^2$ . Then

$$\frac{\partial V}{\partial x} f(x, h(x)) = -|x + \eta(x)|^2, \quad \forall x \in (-\infty, b], \Rightarrow \alpha_1 = 1, \psi_1 = |x + \eta(x)|$$

$$\frac{\partial W}{\partial y} g(x, y + h(x)) = -y^2, \Rightarrow \alpha_2 = 1, \psi_2 = |y|$$

$$\frac{\partial V}{\partial x} [f(x, y + h(x)) - f(x, h(x))] = axy \leq a\psi_1\psi_2 \Rightarrow \beta_1 = a$$

$$\left[ \frac{\partial W}{\partial x} - \frac{\partial W}{\partial y} \frac{\partial h}{\partial x} \right] f(x, y + h(x)) = \frac{1}{a}y[-\eta(x) + ay - x] \leq \frac{1}{a}|y||x + \eta(x)| + |y|^2 \Rightarrow \beta_2 = \frac{1}{a}, \gamma = 1$$

Hence, the origin is asymptotically stable for all  $\varepsilon < \varepsilon^* = \frac{1}{2}$ .

• 11.23 (a) Linearization at the origin yields the matrix  $\begin{bmatrix} 0 & 0 \\ 0 & -1/\varepsilon \end{bmatrix}$  which shows that linearization fails.

(b) Setting  $\varepsilon = 0$  yields  $z = \tan^{-1} x^3$ . The reduced model is  $\dot{x} = -2x^3 + (\tan^{-1} x^3)^2$  and the boundary-layer model is  $\frac{dy}{d\tau} = x^3 - \tan(y + \tan^{-1} x^3)$ . Let  $D = \{|x| \leq a \text{ and } |y + \tan^{-1}(x^3)| \leq b < \pi/2\}$ . All our analysis will be restricted to the set  $D$ . Let  $V(x) = \frac{1}{4}x^4$  and  $W(y) = \frac{1}{2}y^2$ . Then

$$\frac{\partial V}{\partial x} f(x, h(x)) = -2x^6 + x^3(\tan^{-1} x^3)^2 \leq -x^6 \Rightarrow \alpha_1 = 1, \psi_1 = |x|^3$$

where we have used the property  $z(\tan^{-1} z)^2 \leq z^2$ .

$$\frac{\partial W}{\partial y} g(x, y + h(x)) = yx^3 - y \tan(y + \tan^{-1} x^3) \leq -y^2 \Rightarrow \alpha_2 = 1, \psi_2 = |y|$$

## 《非线性系统（第三版）》习题解答

where we have used the property  $z[\tan(z+b) - \tan b] \geq z^2$ .

$$\frac{\partial V}{\partial x}[f(x, y+h(x)) - f(x, h(x))] = x^3 y(y + 2 \tan^{-1} x^3) \leq \beta_1 |x|^3 |y|$$

$$\left[ \frac{\partial W}{\partial x} - \frac{\partial W}{\partial y} \frac{\partial h}{\partial x} \right] f(x, y+h(x)) = -\frac{3x^2 y}{1+x^6} [-2x^3 + (\tan^{-1} x^3)^2 + 2y \tan^{-1} x^3 + y^2] \leq \beta_2 |x|^3 |y| + \gamma |y|$$

where  $\beta_1, \beta_2$  and  $\gamma$  depend on the constants  $a$  and  $b$  of the set  $D$ . Thus, the origin is asymptotically stable for all  $\varepsilon < \varepsilon^*$ , where  $\varepsilon^*$  is given by (11.46). The Lyapunov function is  $\nu(x, y) = (1-d^*)V(x) + d^*W(y)$ , where  $d^* = \beta_1/(\beta_1 + \beta_2)$ . The region of attraction can be estimated by the set  $\{\nu(x, y) \leq c\}$ , where  $c = \min_{\partial D} \{\nu(x, y)\}$ .

• 11.24 The inequalities satisfied by  $V$  and  $W$  imply that  $\nu(x, y) = (1-d)V(x) + dW(y)$  satisfies the inequality

$$c_1 \left\| \begin{bmatrix} x \\ y \end{bmatrix} \right\|^2 \leq \nu(x, y) \leq c_2 \left\| \begin{bmatrix} x \\ y \end{bmatrix} \right\|^2$$

for some positive constants  $c_1$  and  $c_2$ . When  $\psi_1(x) = \|x\|$  and  $\psi_2(y) = \|y\|$ , the inequality  $\dot{\nu} \leq -\psi^T \Lambda \psi$ , for some positive definite matrix  $\Lambda$ , implies

$$\dot{\nu} \leq -c_3 \left\| \begin{bmatrix} x \\ y \end{bmatrix} \right\|^2$$

for some positive constant  $c_3$ . Then, by Theorem 4.10, the origin is exponentially stable.

• 11.25 (a) By smoothness, there is a positive constant  $L$  such that

$$\|g(x, y) - g(x, 0)\|_2 \leq L\|y\|_2$$

$$\begin{aligned} \nu &= (1-d)V(x) + dW(y) \\ \dot{\nu} &= (1-d)\frac{\partial V}{\partial x}f(x, y) + \frac{d}{\varepsilon}\frac{\partial W}{\partial y}[Ay + \varepsilon g_1(x, y)] \\ &= (1-d)\frac{\partial V}{\partial x}f(x, 0) + (1-d)\frac{\partial V}{\partial x}[f(x, y) - f(x, 0)] - \frac{d}{\varepsilon}y^T y + 2dy^T P g_1(x, y) \\ &\leq -(1-d)\alpha_1 \phi + (1-d)k_2 \phi^{1/2} \|y\|_2 - \frac{d}{\varepsilon}y^T y + 2dk_1 \|P\|_2 \phi^{1/2} \|y\|_2 + 2dL\|P\|_2 \|y\|_2^2 \\ &= -(1-d)\alpha_1 \psi_1^2 + (1-d)\beta_1 \psi_1 \psi_2 + d\beta_2 \psi_1 \psi_2 - \frac{d}{\varepsilon} \psi_2^2 + d\gamma \psi_2^2 \end{aligned}$$

where  $\beta_1 = k_2$ ,  $\beta_2 = 2k_1\|P\|_2$ ,  $\gamma = 2L\|P\|_2$ ,  $\psi_1 = \phi^{1/2}$ , and  $\psi_2 = \|y\|_2$ . Hence, the origin is asymptotically stable for sufficiently small  $\varepsilon$ .

(b)

$$\begin{aligned} \nu &= V(x) + (y^T P y)^\gamma \\ \dot{\nu} &= \frac{\partial V}{\partial x}f(x, 0) + \frac{\partial V}{\partial x}[f(x, y) - f(x, 0)] + \gamma (y^T P y)^{\gamma-1} \left[ -\frac{1}{\varepsilon}y^T y + 2y^T P g_1(x, y) \right] \\ &\leq -\alpha_1 \phi + k_4 \phi^b \|y\|_2^c - \frac{\gamma}{\varepsilon} (\lambda_{\min}(P))^{\gamma-1} \|y\|_2^{2\gamma} + \gamma (\lambda_{\max}(P))^{\gamma-1} \|y\|_2^{2\gamma-2} \times 2\|y\|_2 \|P\|_2 (k_3 \phi^a + L\|y\|_2) \\ &= -\alpha_1 \phi + k_4 \phi^b \|y\|_2^c - \frac{\gamma}{\varepsilon} (\lambda_{\min}(P))^{\gamma-1} \|y\|_2^{2\gamma} + 2\gamma k_3 \|P\|_2 \phi^a \|y\|_2^{2\gamma-1} + 2\gamma L \|P\|_2 \|y\|_2^{2\gamma} \end{aligned}$$

Using Young's inequality with  $p = 1/b$  and arbitrary  $\mu_1 > 0$ , we obtain

$$\phi^b \|y\|_2^c \leq \frac{1}{\mu_1} \phi + \mu_1^{b/(b-1)} \|y\|_2^{2\gamma}$$



## 《非线性系统（第三版）》习题解答

Using Young's inequality with  $p = 1/a = 2\gamma$  and arbitrary  $\mu_2 > 0$ , we obtain

$$\phi^a \|y\|_2^{2\gamma-1} \leq \frac{1}{\mu_2} \phi + \mu_2^{1/(2\gamma-1)} \|y\|_2^{2\gamma}$$

Hence,

$$\dot{v} \leq -c_1 \phi - c_2 \|y\|_2^{2\gamma}$$

where

$$c_1 = \alpha_1 - \frac{k_4}{\mu_1} - \frac{2\gamma k_3 \|P\|_2}{\mu_2}$$

$$c_2 = \frac{\gamma}{\varepsilon} (\lambda_{\min}(P))^{\gamma-1} - k_4 \mu_1^{b/(b-1)} - 2\gamma k_3 \|P\|_2 \mu_2^{1/(2\gamma-1)} - 2\gamma L \|P\|_2$$

Choose  $\mu_1$  and  $\mu_2$  large enough to make  $c_1 > 0$ ; then choose  $\varepsilon^*$  small enough such that  $c_2 > 0$  for all  $\varepsilon < \varepsilon^*$ .

(c) Consider the second-order system

$$\dot{x} = -x + y, \quad \varepsilon \dot{y} = -y + \varepsilon g_1(x)$$

Part (a) requires  $|g_1(x)| \leq k_1|x|$ , while part (b) requires  $|g_1(x)| \leq k_3|x|^{2a}$ ,  $0 < a < \frac{1}{2}$ . Take  $g_1(x) = \sqrt{|x|}$ .

• 11.26 Let  $y = z + A^{-1}\eta(x)$  and rewrite the equation as

$$\dot{x} = f(x, y - A^{-1}\eta(x)), \quad \varepsilon D\dot{y} = Ay + \varepsilon DA^{-1} \frac{\partial \eta}{\partial x}$$

The derivative of  $v(x, y) = (1-d)V(x) + dy^T P D y$  along the trajectories of the system is given by

$$\begin{aligned} \dot{v} &= (1-d) \frac{\partial V}{\partial x} f(x, -A^{-1}\eta(x)) + (1-d) \frac{\partial V}{\partial x} [f(x, y - A^{-1}\eta(x)) - f(x, -A^{-1}\eta(x))] \\ &\quad - \frac{d}{\varepsilon} y^T Q y + 2dy^T P D A^{-1} \frac{\partial \eta}{\partial x} f(x, y - A^{-1}\eta(x)) \end{aligned}$$

Suppose that

$$\frac{\partial V}{\partial x} f(x, -A^{-1}\eta(x)) \leq -\alpha_1 \psi_1^2(x)$$

$$\frac{\partial V}{\partial x} [f(x, y - A^{-1}\eta(x)) - f(x, -A^{-1}\eta(x))] \leq \beta_1 \psi_1(x) \|y\|_2$$

$$\left\| \frac{\partial \eta}{\partial x} f(x, y - A^{-1}\eta(x)) \right\|_2 \leq k_1 \psi_1(x) + k_2 \|y\|_2 \Rightarrow 2y^T P D A^{-1} \frac{\partial \eta}{\partial x} f(x, y - A^{-1}\eta(x)) \leq \beta_2 \psi_1(x) \|y\|_2 + \gamma \|y\|_2^2$$

where the constants  $\beta_2$  and  $\gamma$  are chosen to independent of the elements of the matrix  $D$  which is possible since the elements of  $D$  are bounded by one. Now setting  $\alpha_2 = \lambda_{\min}(Q)$  and  $\psi_2(y) = \|y\|_2$ , we see that  $\dot{v}$  satisfies the same inequality  $\dot{v} \leq -\psi^T \Lambda \psi$  that appears on page 452 of the text. Thus, we can continue to prove that the origin is asymptotically stable for sufficiently small  $\varepsilon$ .

• 11.27 Setting  $\varepsilon = 0$  results in  $z = -x_1 x_2$ . The reduced model is

$$\dot{x}_1 = -(x_2 - a)x_1, \quad \dot{x}_2 = bx_1^2$$

The boundary-layer model is  $\frac{dz}{d\tau} = -y$ . We analyzed the reduced model in Example 4.10. There we saw that the reduced model has an equilibrium set  $\{x_1 = 0\}$ . Using the Lyapunov function  $V(x) = \frac{1}{2}x_1^2 + (1/2b)(x_2 - k)^2$ ,  $k > a$ , we applied LaSalle's theorem to show that all solutions approach the equilibrium set as  $t \rightarrow \infty$ . In the current singularly perturbed system, it can be checked that  $\{x_1 = 0, z = 0\}$  is an equilibrium set.

## 《非线性系统（第三版）》习题解答

We will prove that all solutions of the singularly perturbed system approach this set as  $t \rightarrow \infty$ . Apply the change of variables  $y = z + x_1x_2$ . Then,

$$\begin{aligned}\dot{x}_1 &= -(x_2 - a)x_1 + 2y \\ \dot{x}_2 &= bx_1^2 \\ \varepsilon \dot{y} &= -y + \varepsilon[-(x_2 - a)x_1x_2 + 2yx_2 + bx_1^3]\end{aligned}$$

Let  $W(y) = \frac{1}{2}y^2$ . The following inequalities can be easily checked.

$$\frac{\partial V}{\partial x} f(x, h(x)) = -(k - a)x_1^2 = -\alpha_1 \psi_1^2(x), \quad \text{where } \alpha_1 = k - a > 0, \psi_1(x) = |x_1|$$

$$\frac{\partial W}{\partial y} g(x, y + h(x)) = -y^2 = \alpha_2 \psi_2^2(y), \quad \text{where } \alpha_2 = 1, \psi_2 = |y|$$

$$\frac{\partial V}{\partial x} [f(x, y + h(x)) - f(x, h(x))] = 2x_1y \leq \beta_1 \psi_1(x) \psi_2(y), \quad \text{where } \beta_1 = 2$$

$$\left[ \frac{\partial W}{\partial x} - \frac{\partial W}{\partial y} \frac{\partial h}{\partial x} \right] f(x, y + h(x)) = -yx_1x_2(x_2 - a) + 2x_2y^2 + bx_1^3y \leq \beta_2 \psi_1(x) \psi_2(y) + \gamma \psi_2^2(y)$$

where  $\beta_2$  and  $\gamma$  are positive constants such that the domain of interest is a subset of the set  $D$  defined by

$$D = \{2x_2 \leq \gamma \text{ and } |bx_1^3 - x_2(x_2 - a)| \leq \beta_2\}$$

By comparison with the proof of Theorem 11.3, it is now clear the the derivative of  $v(x, y) = (1 - d)V(x) + dW(y)$  along the trajectories of the system satisfies the inequality  $\dot{v} \leq -\psi^T \Lambda \psi$ , where the matrix  $\Lambda$  is positive definite for sufficiently small  $\varepsilon$ . Hence

$$\dot{v} \leq -\lambda(\psi_1^2(x) + \psi_2^2(y)), \quad \lambda > 0$$

The difference from Theorem 11.3 is that in the current case the foregoing inequality shows only that  $\dot{v}$  is negative semidefinite because  $\psi_1(x) = |x_1|$  is not a positive definite function of  $x$ ; that is, it vanishes at  $x_1 = 0$  for all values of  $x_2$ . It is clear though that all solutions starting in  $\{v(x, y) \leq c\} \subset D$  will remain in this set for all  $t \geq 0$ . Moreover, by Theorem 8.4, we conclude that  $x_1(t)$  and  $y(t)$  tend to zero as  $t \rightarrow \infty$ . Consequently,  $z(t) = y(t) - x_1(t)x_2(t)$  tends to zero as  $t \rightarrow \infty$ .

• 11.28 View the given system as a perturbation of the system

$$\dot{x}_1 = x_2, \quad \dot{x}_2 = -x_2 + z, \quad \varepsilon \dot{z} = -(x_1 + z) - (x_1 + z)^3$$

The perturbation term satisfies  $|e^{-t}z| \leq e^{-t}|z|$ . It follows from Corollary 9.1 and part 2 of Lemma 9.5 that if the origin of the nominal system is globally exponentially stable, so is the origin of the perturbed system. Thus, we only need to show that the origin of the nominal system is globally exponentially stable. We use the singular perturbation stability analysis. Setting  $\varepsilon = 0$  results in  $z = -x_1$ . The reduced model is

$$\dot{x}_1 = x_2, \quad \dot{x}_2 = -x_1 - x_2$$

This is a linear time-invariant system with a Hurwitz matrix  $A = \begin{bmatrix} 0 & 1 \\ -1 & -1 \end{bmatrix}$ . A Lyapunov function  $V(x)$  can be taken as  $V(x) = x^T P x$ , where  $P$  is the solution of the Lyapunov equation  $PA + A^T P = -I$ . Inequality (11.39) is satisfied with  $\psi_1(x) = \|x\|_2$  and  $\alpha_1 = 1$ . Define  $y = z + x_1$ . The boundary-layer model is  $\frac{dy}{d\tau} = -y - y^3$ . The function  $W(y) = \frac{1}{2}y^2$  satisfies

$$\frac{\partial W}{\partial y} (-y - y^3) = -y^2 - y^4 \leq -y^2$$

## 《非线性系统（第三版）》习题解答

Inequality (11.40) is satisfied with  $\psi_2(y) = |y|$  and  $\alpha_2 = 1$ . Let us verify the interconnection inequalities (11.43) and (11.44).

$$\begin{aligned} \frac{\partial V}{\partial x} [f(x, y + h(x)) - f(x, h(x))] &= 2x^T P \begin{bmatrix} 0 \\ y \end{bmatrix} \leq 2\|PB\|_2 \|x\|_2 |y| \\ -\frac{\partial W}{\partial y} \frac{\partial h}{\partial x} f(x, y + h(x)) &= -y \begin{bmatrix} -1 & 0 \end{bmatrix} \begin{bmatrix} x_2 \\ -x_1 - x_2 + y \end{bmatrix} = yx_2 \leq \|x\|_2 |y| \end{aligned}$$

where  $B = \begin{bmatrix} 0 \\ 1 \end{bmatrix}$ . Thus, all the conditions of Theorem 11.3 are satisfied globally with  $\alpha_1 = 1$ ,  $\alpha_2 = 1$ ,  $\beta_1 = 2\|PB\|_2$ ,  $\beta_2 = 1$ , and  $\gamma = 0$ . Since  $V(x)$  and  $W(y)$  are quadratic functions and  $\psi_1(x) = \|x\|_2$  and  $\psi_2(y) = |y|$ , we conclude that the origin is globally exponentially stable for  $0 < \varepsilon < \varepsilon^* = 1/2\|PB\|_2$ . Notice that we cannot conclude global exponential stability from Theorem 11.4 because the term  $(x_1 + z)^3$  is not globally Lipschitz.

• **11.29 (a)** Note that  $\tan^{-1}(z)$  is globally Lipschitz with a Lipschitz constant equal to one because

$$\frac{d}{dz} \tan^{-1}(z) = \frac{1}{1+z^2}$$

With  $y = x + z$ , the unforced system is given by

$$\dot{x} = -x + \tan^{-1}(-x + y), \quad \varepsilon \dot{y} = -y + \varepsilon[-x + \tan^{-1}(-x + y)]$$

Let  $v = \frac{1}{2}x^2 + \frac{1}{2}y^2$ .

$$\begin{aligned} \dot{v} &= -x^2 + x \tan^{-1}(-x + y) - \frac{y^2}{\varepsilon} + y[-x + \tan^{-1}(-x + y)] \\ &= -x^2 - x \tan^{-1}(x) + x[\tan^{-1}(-x + y) - \tan^{-1}(-x)] - \frac{y^2}{\varepsilon} - xy + y \tan^{-1}(-x + y) \\ &= -x^2 - x \tan^{-1}(x) - \frac{y^2}{\varepsilon} + y \left[ \frac{x}{1 + (-x + \zeta y)^2} - x + \tan^{-1}(-x + y) \right], \quad 0 < \zeta < 1 \\ &\leq -x^2 - \frac{y^2}{\varepsilon} + |y| |x| + |y| | -x + y| \\ &\leq - \begin{bmatrix} |x| \\ |y| \end{bmatrix}^T \begin{bmatrix} 1 & -1 \\ -1 & \frac{1}{\varepsilon} - 1 \end{bmatrix} \begin{bmatrix} |x| \\ |y| \end{bmatrix} \end{aligned}$$

The  $2 \times 2$  matrix is positive definite for  $\varepsilon < \varepsilon^* = \frac{1}{2}$ . Since  $v$  and the upper bound on  $\dot{v}$  are quadratic and the change of variables  $y = z + x$  is linear, we conclude that the origin is globally exponentially stable for all  $\varepsilon < \frac{1}{2}$ .

(b) Input-to-state stability follows from Lemma 4.6.

• **11.30 (a)** The closed-loop system is given by

$$\dot{x}_1 = x_2, \quad \dot{x}_2 = -x_1 - 2x_2 + z, \quad \varepsilon \dot{z} = -z - \psi(2x_1 + x_2)$$

Setting  $\varepsilon = 0$  results in  $z = -\psi(2x_1 + x_2) = h(x)$ . The reduced model is

$$\dot{x}_1 = x_2, \quad \dot{x}_2 = -x_1 - 2x_2 - \psi(2x_1 + x_2)$$

The boundary-layer model is  $\frac{\partial y}{\partial \tau} = -y$ .

(b) The reduced system can be represented as a feedback connection of the linear system

$$\dot{x}_1 = x_2, \quad \dot{x}_2 = -x_1 - 2x_2 + u, \quad y = 2x_1 + x_2$$

## 《非线性系统（第三版）》习题解答

and the nonlinear function  $u = -\psi(y)$ . The transfer function of the linear system is  $G(s) = (s + 2)/(s + 1)^2$ . For any  $k > 0$ , the transfer function  $1 + kG(s)$  is strictly positive real because

$$1 + k\operatorname{Re}[G(j\omega)] = 1 + \frac{2k}{(1 + \omega^2)^2} > 0, \quad \forall \omega \in R$$

and  $1 + kG(\infty) = 1 > 0$ . Thus, by Theorem 7.1, the system is absolutely stable for any finite  $k > 0$ . Moreover, a Lyapunov function is given by  $V(x) = \frac{1}{2}x^T P x$ , where  $P$  satisfies equations (7.6)-(7.8). We replace  $\varepsilon$  in (7.6) by  $\mu > 0$ . Thus,  $V(x)$  satisfies (11.39) with  $\alpha_1 = \frac{1}{2}\mu\lambda_{\min}(P)$  and  $\psi_1(x) = \|x\|_2$ . For the boundary-layer system,  $W(y) = \frac{1}{2}y^2$  satisfies (11.40) with  $\alpha_2 = 1$  and  $\psi_2(y) = |y|$ . Let us check the interconnection conditions (11.43) and (11.44).

$$\frac{\partial V}{\partial x}[f(x, y + h(x)) - f(x, h(x))] = x^T P \begin{bmatrix} 0 \\ y \end{bmatrix} \leq \|PB\|_2 \|x\|_2 |y|, \quad \text{where } B = \begin{bmatrix} 0 \\ 1 \end{bmatrix}$$

Thus, (11.43) is satisfied with  $\beta_1 = \|PB\|_2$ .

$$-\frac{\partial W}{\partial y} \frac{\partial h}{\partial x} f(x, y + h(x)) = y\psi'(2x_1 + x_2)[2x_2 - x_1 - 2x_2 + y - \psi(2x_1 + x_2)]$$

Suppose that  $\psi'(\cdot)$  is globally bounded. Then,

$$\left| -\frac{\partial W}{\partial y} \frac{\partial h}{\partial x} f(x, y + h(x)) \right| \leq L|y|\|x\|_2 + L^2\sqrt{5}|y|\|x\|_2 + L|y|^2$$

where  $L$  is a Lipschitz constant for  $\phi$ . Hence, (11.44) is satisfied with  $\beta_2 = L + L^2\sqrt{5}$  and  $\gamma = L$ . Thus, all the conditions of Theorem 11.3 are satisfied globally and we can conclude that, for sufficiently small  $\varepsilon$ , the origin is globally asymptotically stable; that is, the system is absolutely stable. If  $\psi$  is not globally Lipschitz, it will be Lipschitz on any compact set, due to smoothness. In this case, we can conclude absolute stability with a finite domain.

## 《非线性系统（第三版）习题解答

# Chapter 12

- 12.1 We represent the closed-loop system as a perturbation of its linearization at the origin.

$$\dot{x} = (A - BK)x + Bg(x_1)$$

where

$$A - BK = \begin{bmatrix} 0 & 1 \\ -10(2.5 + 1/\sqrt{2}) & -10 \end{bmatrix}, \quad B = \begin{bmatrix} 0 \\ 1 \end{bmatrix}, \quad g(x_1) = -10 \left[ \sin\left(x_1 + \frac{\pi}{4}\right) - \frac{1}{\sqrt{2}} - \frac{x_1}{\sqrt{2}} \right]$$

It can be easily seen that  $|g(x_1)| \leq 5x_1^2$ . We use  $V(x) = x^T P x$  as a Lyapunov function, where  $P = \begin{bmatrix} 1.8095 & 0.0156 \\ 0.0156 & 0.0516 \end{bmatrix}$  is the solution of the Lyapunov equation  $P(A - BK) + (A - BK)^T P = -I$ .

$$\begin{aligned} \dot{V}(x) &= -x^T x + 2x^T P B g(x_1) \leq -\|x\|_2^2 + 2\|x\|_2 \|P B\|_2 5x_1^2 \\ &\leq -[1 - 0.5386|x_1|]\|x\|_2^2 < 0, \quad \forall |x_1| < 1.8567 \end{aligned}$$

Hence,  $\dot{V}(x)$  is negative definite in the region  $\{|x_1| < 1.8567\}$ . We estimate the region of attraction by  $\Omega_c = \{V(x) \leq c\} \subset \{|x_1| < 1.8567\}$ . It can be verified that

$$\min_{|x_1|=1.8567} \{x^T P x\} = \frac{(1.8567)^2}{L^T P^{-1} L} = 6.2216$$

where  $L^T = [1 \ 0]$ . Thus, we estimate the region of attraction by the set  $\{V(x) \leq 6.22\}$ .

- 12.2 (1) Linearization at the origin yields

$$A = \frac{\partial f}{\partial x}(0,0) = \begin{bmatrix} 1 & 1 \\ 1 & 0 \end{bmatrix}, \quad B = \frac{\partial f}{\partial u}(0,0) = \begin{bmatrix} 0 \\ 1 \end{bmatrix}, \quad C = \frac{\partial h}{\partial x}(0) = [0 \ 1]$$

- (a) The state feedback control  $u = -Kx = -[7 \ 4]x$  assigns the closed-loop eigenvalues at  $-1$  and  $-2$ .
- (b) Use the observer-based controller

$$\dot{\hat{x}} = (A - BK - HC)\hat{x} + Hy, \quad u = -K\hat{x}$$

with  $K$  as in part (a) and  $H = \begin{bmatrix} 43 \\ 12 \end{bmatrix}$ , which assigns the observer eigenvalues at  $-5$  and  $-6$ .

- (2) Linearization at the origin yields

$$A = \frac{\partial f}{\partial x}(0,0) = \begin{bmatrix} 1 & 1 & 0 \\ -1 & 0 & 1 \\ 0 & 0 & 0 \end{bmatrix}, \quad B = \frac{\partial f}{\partial u}(0,0) = \begin{bmatrix} 0 \\ 0 \\ 1 \end{bmatrix}, \quad C = \frac{\partial h}{\partial x}(0) = [0 \ 1 \ 0]$$

## 《非线性系统（第三版）》习题解答

(a) The state feedback control  $u = -Kx = -[16 \ 17 \ 7]x$  assigns the closed-loop eigenvalues at  $-1$ ,  $-2$ , and  $-3$ .

(b) Use the observer-based controller

$$\dot{\hat{x}} = (A - BK - HC)\hat{x} + Hy, \quad u = -K\hat{x}$$

with  $K$  as in part (a) and  $H = \begin{bmatrix} -335 \\ 19 \\ -210 \end{bmatrix}$ , which assigns the observer eigenvalues at  $-5$ ,  $-6$ , and  $-7$ .

(3) Linearization at the origin yields

$$A = \frac{\partial f}{\partial x}(0,0) = \begin{bmatrix} -1 & 1 & 0 \\ 1 & -1 & 0 \\ 1 & 0 & -2 \end{bmatrix}, \quad B = \frac{\partial f}{\partial u}(0,0) = \begin{bmatrix} 0 \\ 1 \\ 0 \end{bmatrix}, \quad C = \frac{\partial h}{\partial x}(0) = [1 \ 0 \ 0]$$

(a) The state feedback control  $u = -Kx = -[1 \ 2 \ 0]x$  assigns the closed-loop eigenvalues at  $-1$ ,  $-2$ , and  $-3$ .

(b) Use the observer-based controller

$$\dot{\hat{x}} = (A - BK - HC)\hat{x} + Hy, \quad u = -K\hat{x}$$

with  $K$  as in part (a) and  $H = \begin{bmatrix} 9 \\ 21 \\ 1 \end{bmatrix}$ , which assigns the observer eigenvalues at  $-5$ ,  $-6$ , and  $-2$ .

• 12.3 Use the PBH controllability test.

$$\text{rank} \begin{bmatrix} sI_{n+p} - A & B \end{bmatrix} = \text{rank} \begin{bmatrix} sI_n - A & 0 & B \\ -C & sI_p & 0 \end{bmatrix}$$

$$\text{For } s \neq 0, \text{ rank} \begin{bmatrix} sI_n - A & 0 & B \\ -C & sI_p & 0 \end{bmatrix} = p + \text{rank} \begin{bmatrix} sI_n - A & B \end{bmatrix}$$

$$\text{For } s = 0, \text{ rank} \begin{bmatrix} sI_n - A & 0 & B \\ -C & sI_p & 0 \end{bmatrix} = \text{rank} \begin{bmatrix} A & B \\ C & 0 \end{bmatrix}$$

Hence,  $(A, B)$  is controllable if and only if  $(A, B)$  is controllable and the rank condition (12.23) is satisfied.

• 12.4 (a) A state feedback integral controller is designed in Example 12.4. For output feedback, use the observer

$$\dot{\hat{x}} = (A - HC)\hat{x} + Bu + Hy$$

where  $y = \theta - \delta$ , and replace  $\dot{\theta}$  by  $\dot{\hat{x}}_2$  in the control law. The observer gain  $H$  is designed such that

$$A - HC = \begin{bmatrix} -h_1 & 1 \\ -h_2 - a \cos \delta & -b \end{bmatrix}$$

is Hurwitz. Using the Routh-Hurwitz criterion, it can be shown that  $A - HC$  is Hurwitz if

$$h_1 > -b, \quad h_2 > -a \cos \delta - h_1 b$$

(b) A state feedback integral controller is designed in Example 12.4, for a fixed  $\theta_r = \delta$ , as

$$u = -k_1(\delta)(\theta - \delta) - k_2(\delta)\dot{\theta} - k_3(\delta)\sigma, \quad \dot{\sigma} = \theta - \delta$$

where the gains  $k_1$ ,  $k_2$ , and  $k_3$  are, in general, functions of  $\delta$ . In a gain scheduled controller,  $\delta$  is replaced by the scheduling variable  $\theta_r$ . To ensure that the linearization of the closed-loop system at each operating point

## 《非线性系统（第三版）》习题解答

is the same as the feedback connection of the parameterized linear system and the corresponding controller, we modify the gain scheduled controller to

$$u = -k_1(\theta_r)(\theta - \theta_r) - k_2(\theta_r)\dot{\theta} + z, \quad \dot{z} = -k_3(\theta_r)(\theta - \theta_r)$$

In this modification, we kept the first two terms since both  $\theta - \theta_r$  and  $\dot{\theta}$  vanish at the equilibrium point.

(c) The observer-based integral controller designed in Exercise 12.4 and part (a) is given by

$$u = -k_1(\delta)(\theta - \delta) - k_2(\delta)\hat{x}_2 - k_3(\delta)\sigma, \quad \dot{\sigma} = \theta - \delta$$

$$\dot{\hat{x}} = [A(\delta) - H(\delta)C]\hat{x} + Bu + H(\delta)y = [A(\delta) - BK(\delta) - H(\delta)C]\hat{x} - Bk_3(\delta)\sigma + H(\delta)y$$

The controller takes the form of the original block diagram of Figure 12.4 with  $F = A - BK - HC$ ,  $G = [-Bk_3 \ H]$ ,  $L = [0 \ -k_2]$ ,  $M = [-k_3 \ 0]$ ,  $M_3 = -k_1$ , and  $y_m = y$ . Applying the modification of Figure 12.4, we obtain the gain scheduled controller

$$\begin{aligned} \dot{z} &= [A(\theta_r) - BK(\theta_r) - H(\theta_r)C]z - Bk_3(\theta_r)(\theta - \theta_r) + H(\theta_r)\dot{y} \\ v &= -k_2(\theta_r)z_2 - k_3(\theta_r)(\theta - \theta_r) \\ \dot{\eta} &= v \\ u &= \eta - k_1(\theta)(\theta - \theta_r) \end{aligned}$$

where  $\dot{y}$  is obtained from  $y = \theta - \theta_r$  by using the filter (12.55)–(12.56).

• 12.5 (a) Since  $e^{-2c\tau} \leq e^{-2c\sigma} \leq 1, \forall 0 \leq \sigma \leq \tau$ , we have

$$\begin{aligned} Q(\alpha) &= \int_0^\tau e^{-2c\sigma} \exp[-A(\alpha)\sigma]B(\alpha)B^T(\alpha) \exp[-A^T(\alpha)\sigma] d\sigma \\ &\geq e^{-2c\tau} \int_0^\tau \exp[-A(\alpha)\sigma]B(\alpha)B^T(\alpha) \exp[-A^T(\alpha)\sigma] d\sigma = e^{-2c\tau}W(\alpha) \geq e^{-2c\tau}c_1I \\ Q(\alpha) &= \int_0^\tau e^{-2c\sigma} \exp[-A(\alpha)\sigma]B(\alpha)B^T(\alpha) \exp[-A^T(\alpha)\sigma] d\sigma \\ &\leq \int_0^\tau \exp[-A(\alpha)\sigma]B(\alpha)B^T(\alpha) \exp[-A^T(\alpha)\sigma] d\sigma = W(\alpha) \leq c_2I \end{aligned}$$

(b)

$$\begin{aligned} \dot{V} &= x^T \{P(\alpha)[A(\alpha) - B(\alpha)K(\alpha)] + [A(\alpha) - B(\alpha)K(\alpha)]^T P(\alpha)\} x \\ &= x^T [P(\alpha)A(\alpha) + A^T(\alpha)P(\alpha) - P(\alpha)B(\alpha)B^T(\alpha)P(\alpha)] x \\ &= x^T P(\alpha)[A(\alpha)Q(\alpha) + Q(\alpha)A^T(\alpha) - B(\alpha)B^T(\alpha)]P(\alpha)x \end{aligned}$$

$$\begin{aligned} A(\alpha)Q(\alpha) + Q(\alpha)A^T(\alpha) &= \int_0^\tau e^{-2c\sigma} A(\alpha) \exp[-A(\alpha)\sigma]B(\alpha)B^T(\alpha) \exp[-A^T(\alpha)\sigma] d\sigma \\ &\quad + \int_0^\tau e^{-2c\sigma} \exp[-A(\alpha)\sigma]B(\alpha)B^T(\alpha) \exp[-A^T(\alpha)\sigma]A^T(\alpha) d\sigma \\ &= - \int_0^\tau e^{-2c\sigma} \frac{d}{d\sigma} \{ \exp[-A(\alpha)\sigma]B(\alpha)B^T(\alpha) \exp[-A^T(\alpha)\sigma] \} d\sigma \end{aligned}$$

Integrating the right-hand side by parts, we obtain

$$A(\alpha)Q(\alpha) + Q(\alpha)A^T(\alpha) = -e^{-2c\tau} \exp[-A(\alpha)\tau]B(\alpha)B^T(\alpha) \exp[-A^T(\alpha)\tau] + B(\alpha)B^T(\alpha) - 2cQ(\alpha)$$

## 《非线性系统（第三版）》习题解答

Therefore

$$A(\alpha)Q(\alpha) + Q(\alpha)A^T(\alpha) - B(\alpha)B^T(\alpha) \leq -2cQ(\alpha)$$

Hence

$$\dot{V} \leq -2cx^T P(\alpha)Q(\alpha)P(\alpha)x = -2cx^T P(\alpha)x = -2cV$$

(c)

$$k_1 \|x\|_2^2 \leq V \leq k_2 \|x\|_2^2, \quad \dot{V} \leq -2cV$$

where  $k_1 = c_1 e^{-2c\tau}$  and  $k_2 = c_2$ . From the comparison lemma,

$$V(t) \leq e^{-2ct}V(0)$$

$$\|x(t)\|_2 \leq \frac{1}{\sqrt{k_1}} \sqrt{V(t)} \leq \frac{e^{-ct}}{\sqrt{k_1}} \sqrt{V(0)} \leq \sqrt{\frac{k_2}{k_1}} e^{-ct} \|x(0)\|_2$$

• 12.6 Since  $P$  is block triangular, it is nonsingular if and only if  $\begin{bmatrix} G_1 & F \\ M_1 & L \end{bmatrix}$  is nonsingular. By interchanging rows, the latter matrix is nonsingular if and only if  $\begin{bmatrix} M_1 & L \\ G_1 & F \end{bmatrix}$  is nonsingular. It is argued on page 484 that  $\begin{bmatrix} M_1 & L \\ G_1 & F \end{bmatrix}$  is nonsingular. Hence,  $P$  is nonsingular. Verifying that  $P$  satisfies (12.51) is straightforward.

• 12.7 Let  $x_1 = \psi - \psi_r$ ,  $x_2 = \dot{\psi}$ , and  $u = \delta$ . Augment the state equation with the integrator  $\dot{\sigma} = x_1$ . Define  $x = [x_1, x_2, \sigma]^T$ . The augmented state model is given by  $\dot{x} = Ax + Bu$ , where

$$A = \begin{bmatrix} 0 & 1 & 0 \\ 0 & -1/\tau & 0 \\ 1 & 0 & 0 \end{bmatrix}, \quad B = \begin{bmatrix} 0 \\ k/\tau \\ 0 \end{bmatrix}$$

where  $1/\tau = (1/\tau_0)(v/v_0)$  and  $k/\tau = (k_0/\tau_0)(v/v_0)^2$ . The state feedback control

$$u = -12 \left( \frac{\tau}{k} \right) - \left[ 9 \left( \frac{\tau}{k} \right) - \left( \frac{1}{k} \right) \right] - 6 \left( \frac{\tau}{k} \right)$$

assigns the closed-loop eigenvalues at  $-7.5082, -0.7459 \pm 0.4927j$ . the closed-loop transfer function from  $\psi_r$  to  $\psi$  is given by

$$\frac{6(2s+1)}{s^3 + 9s^2 + 12s + 6}$$

and has a step response with 20% overshoot and 6.4 sec. settling time. A gain scheduled controller can be taken as

$$u = -12 \left( \frac{\tau_0}{k_0} \right) \left( \frac{v_0}{v} \right)^2 - \left[ 9 \left( \frac{\tau_0}{k_0} \right) \left( \frac{v_0}{v} \right)^2 - \left( \frac{1}{k_0} \right) \left( \frac{v_0}{v} \right) \right] - 6 \left( \frac{\tau_0}{k_0} \right) \left( \frac{v_0}{v} \right)^2$$

Since the scheduling variable is not the reference input, we don't need the modification of Figure 12.4.

• 12.8 (a) The equilibrium equations are

$$0 = \bar{x}_2, \quad 0 = g - \frac{k}{m} \bar{x}_2 - \frac{L_0 a \bar{x}_3^2}{2m(a + \bar{x}_1)^2}, \quad 0 = -R \bar{x}_3 + \frac{L_0 a \bar{x}_2 \bar{x}_3}{(a + \bar{x}_1)^2} + \bar{u}$$

Set  $\bar{x}_1 = y_{ss} = r$ ,  $\bar{x}_3 = I_{ss}$ ,  $\bar{u} = u_{ss} = V_{ss}$ , and  $x_{ss} = \bar{x}$ . Then,

$$I_{ss} = \left( \frac{2mg(a+r)^2}{L_0 a} \right)^{1/2}, \quad V_{ss} = I_{ss}$$



## 《非线性系统（第三版）》习题解答

(b)

$$\left. \frac{\partial f}{\partial x} \right|_{x=x_{ss}} = \begin{bmatrix} 0 & 1 & 0 \\ c_1 & -c_2 & -c_3 \\ 0 & c_4 & -c_5 \end{bmatrix}$$

where the positive constants  $c_1$  through  $c_5$  are given by

$$c_1 = \frac{L_0 a I_{ss}^2}{m(a+r)^3}, \quad c_2 = \frac{k}{m}, \quad c_3 = \frac{L_0 a I_{ss}}{m(a+r)^2}, \quad c_4 = \frac{L_0 a I_{ss}}{L(r)(a+r)^2}, \quad c_5 = \frac{R}{L(r)}$$

The characteristic equation

$$s^3 + (c_2 + c_5)s^2 + (c_2 c_5 + c_3 c_4 - c_1)s - c_1 c_5 = 0$$

has a negative coefficient  $-c_1 c_5$ . Hence, by the Routh-Hurwitz criterion, the matrix has eigenvalues in the right-half plane. The equilibrium point is unstable.

(c) The linearized system is given by

$$\dot{x}_\delta = Ax_\delta + Bu_\delta$$

where  $x_\delta = x - x_{ss}$ ,  $u_\delta = u - u_{ss}$ ,  $A$  is given in part (b), and  $B = [0, 0, 1/L(r)]^T$ . It can be verified that  $(A, B)$  is controllable.  $K$  is designed to assign the eigenvalues of  $(A - BK)$  at  $-10, -10 \pm j10$ . The control  $u$  is given by

$$u = 62.9295(x_1 - r) + 4.4432x_2 + 0.2502(x_3 - I_{ss}) + V_{ss}$$

where  $V_{ss} = I_{ss} = 6.2642$ .

(d) The step response of  $y$  and  $u$  for  $y(0) = 0$  and  $y(0) = 0.07$  (with other initial states equal to zero) are shown in Figure 12.1. To account for the constraint  $0 \leq u \leq 15$ , a limiter is included in the Simulink simulation model. The response is considered feasible only if  $y$  belongs to the interval  $[0, 0.1]$ . Using this criterion, 0.07 is the largest acceptable initial position.

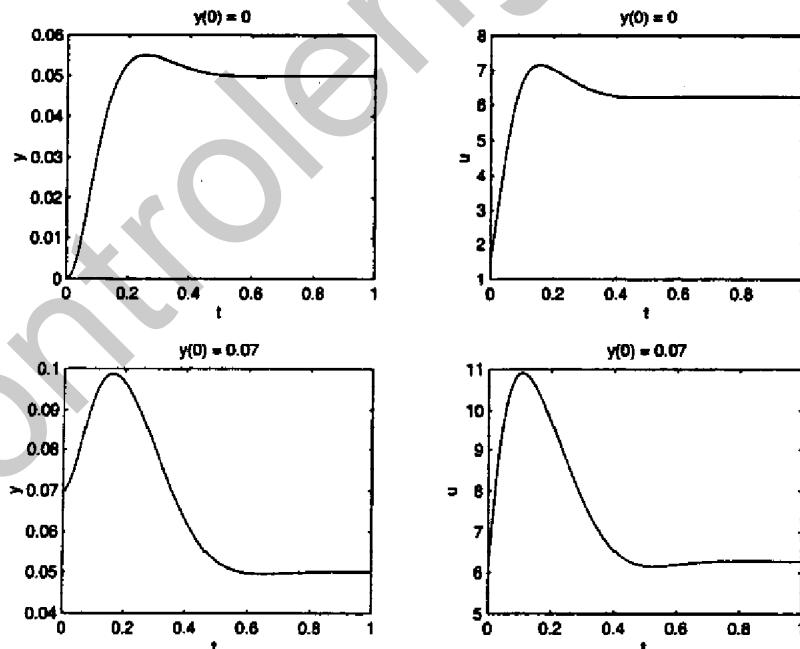

Figure 12.1: Exercise 12.8.

(e) Figure 12.2 shows the response for different values of  $m$ . These values are the extreme values for which

## 《非线性系统（第三版）》习题解答

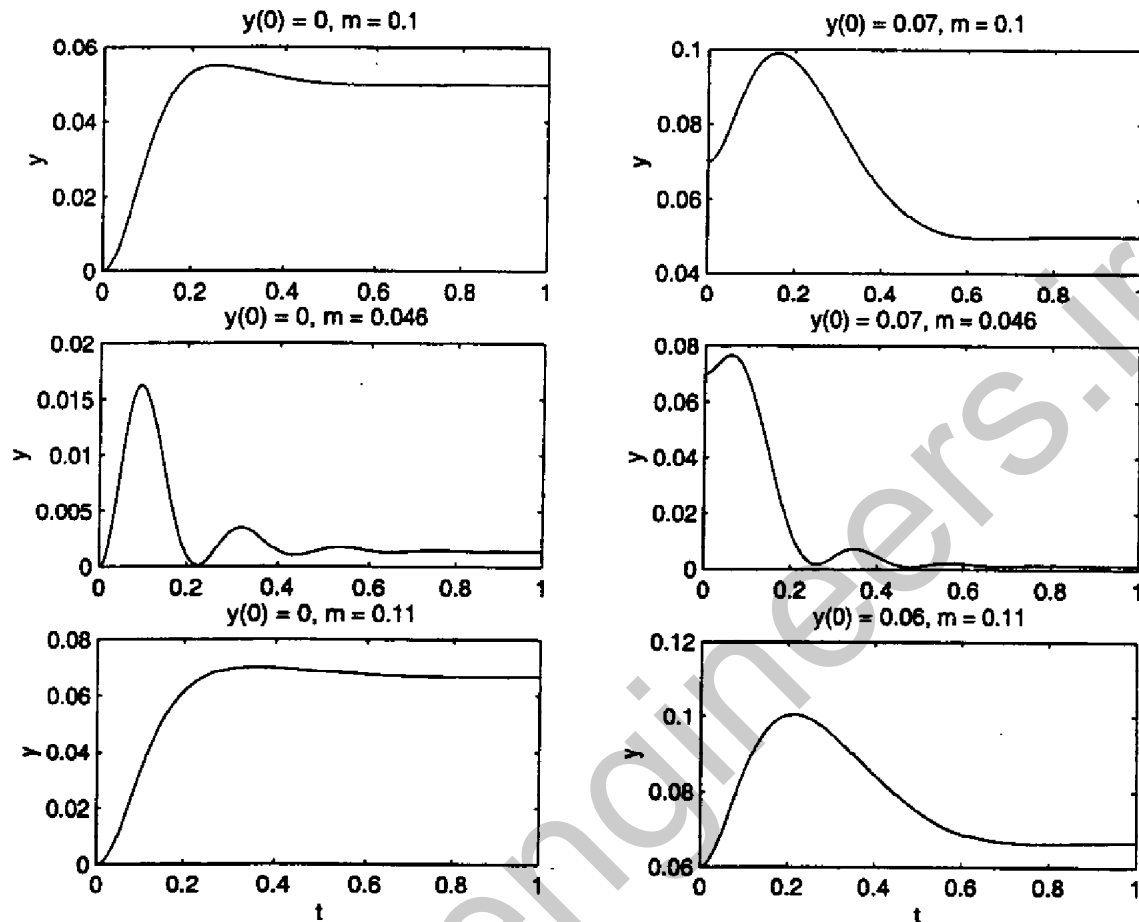

Figure 12.2: Exercise 12.8.

a feasible response is obtained for the given initial position. There is a large steady-state error.

(f) The integrator  $\dot{\sigma} = x_1 - r$  is augmented with the state equation. A matrix  $K = [k_1 \ k_2 \ k_3 \ k_4]$  is designed to assign the eigenvalues of

$$\begin{bmatrix} 0 & 1 & 0 & 0 \\ 196.2 & -0.01 & -3.1321 & 0 \\ k_1 & k_2 + 12.5284 & k_3 - 40 & k_0 \\ 1 & 0 & 0 & 0 \end{bmatrix}$$

at  $-8, -10 \pm j10, -12$ . The control is given by

$$u = 109.8789x_1 + 6.805x_2 + 0.00025x_3 + 153.2522\sigma$$

The step response is shown in Figure 12.3 for the nominal mass and in Figure 12.4 for different values of  $m$ . It is clear that the control achieves zero steady-state error despite the perturbations in  $m$ . The transient response is, in general, worse than the design without integral control. For example, in the case  $m = 0.1$  and  $y(0) = 0$ , the integral controller has about 60% overshoot, compared with 10% overshoot in the case without integral control.

The solutions of the following four parts do not repeat the simulations of parts (d) and (e). The simulations should show a trend similar to what we have seen before.

## 《非线性系统（第三版）》习题解答

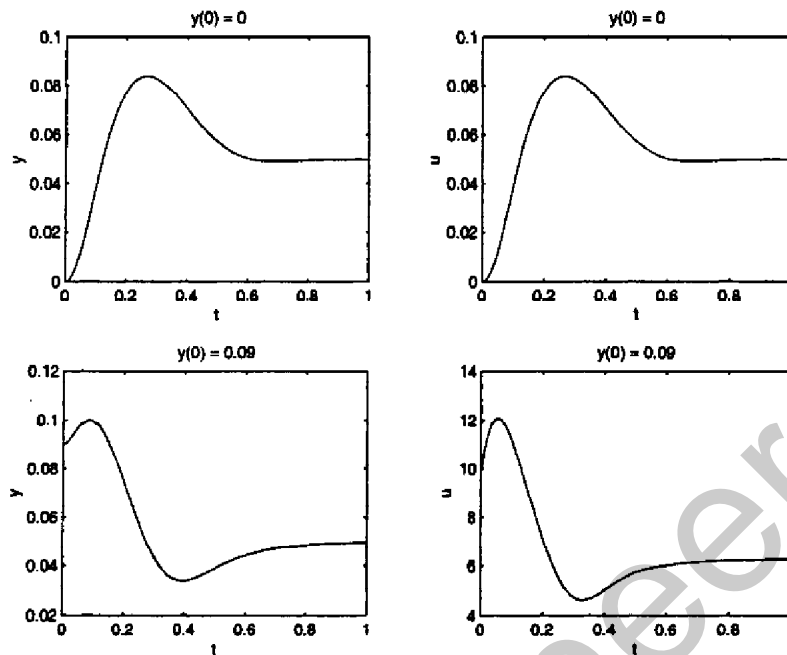

Figure 12.3: Exercise 12.8.

(g) Use the observer-based controller

$$\dot{\hat{x}} = A\hat{x} + Bu + H(y - C\hat{x}), \quad u = 62.9295(x_1 - r) + 4.4432\hat{x}_2 + 0.2502(\hat{x}_3 - I_{ss}) + V_{ss}$$

where  $C = [1 \ 0 \ 0]$  and  $H = \begin{bmatrix} 20 \\ 956.8 \\ 4857.7 \end{bmatrix}$  assigns the eigenvalues of  $(A - HC)$  at  $-20, -20 \pm j20$ .

(h) Use the observer-based controller

$$\dot{\hat{x}} = A\hat{x} + Bu + H(y - C\hat{x}), \quad u = 62.9295(x_1 - r) + 4.4432\hat{x}_2 + 0.2502(x_3 - I_{ss}) + V_{ss}$$

where  $C = \begin{bmatrix} 1 & 0 & 0 \\ 0 & 0 & 1 \end{bmatrix}$  and  $H = \begin{bmatrix} 2.2405 & 3.0131 \\ 201.2620 & 60.2870 \\ 3.0131 & -0.2505 \end{bmatrix}$  assigns the eigenvalues of  $(A - HC)$  at  $-20, -20 \pm j20$ .

(i) Use the observer of part (g) and replace  $x_2$  and  $x_3$  in the control law by their estimates  $\hat{x}_2$  and  $\hat{x}_3$ .

(j) Use the observer of part (h) and replace  $x_2$  in the control law by its estimate  $\hat{x}_2$ .

(k) For state feedback, we solve the pole placement problem at  $\tau = 0.03, 0.05,$  and  $0.07$  to assign the closed-loop eigenvalues at  $-8, -10 \pm j10, -12$ . The resulting feedback gains are

$$K_{03} = [-105.4498 \quad -5.9167 \quad 0.0497 \quad -128.7319]$$

$$K_{05} = [-109.8789 \quad -6.8050 \quad -0.00025 \quad -153.2522]$$

$$K_{07} = [-115.3518 \quad -7.6934 \quad -0.0336 \quad -177.7726]$$

We use linear interpolation to determine  $K$  for other values of  $\tau$ :

$$K_\tau = K_{03} + \left( \frac{\tau - 0.03}{0.02} \right) (K_{05} - K_{03}), \quad \text{for } 0.03 \leq \tau \leq 0.05$$

$$K_\tau = K_{05} + \left( \frac{\tau - 0.05}{0.02} \right) (K_{07} - K_{05}), \quad \text{for } 0.05 \leq \tau \leq 0.07$$

## 《非线性系统（第三版）》习题解答

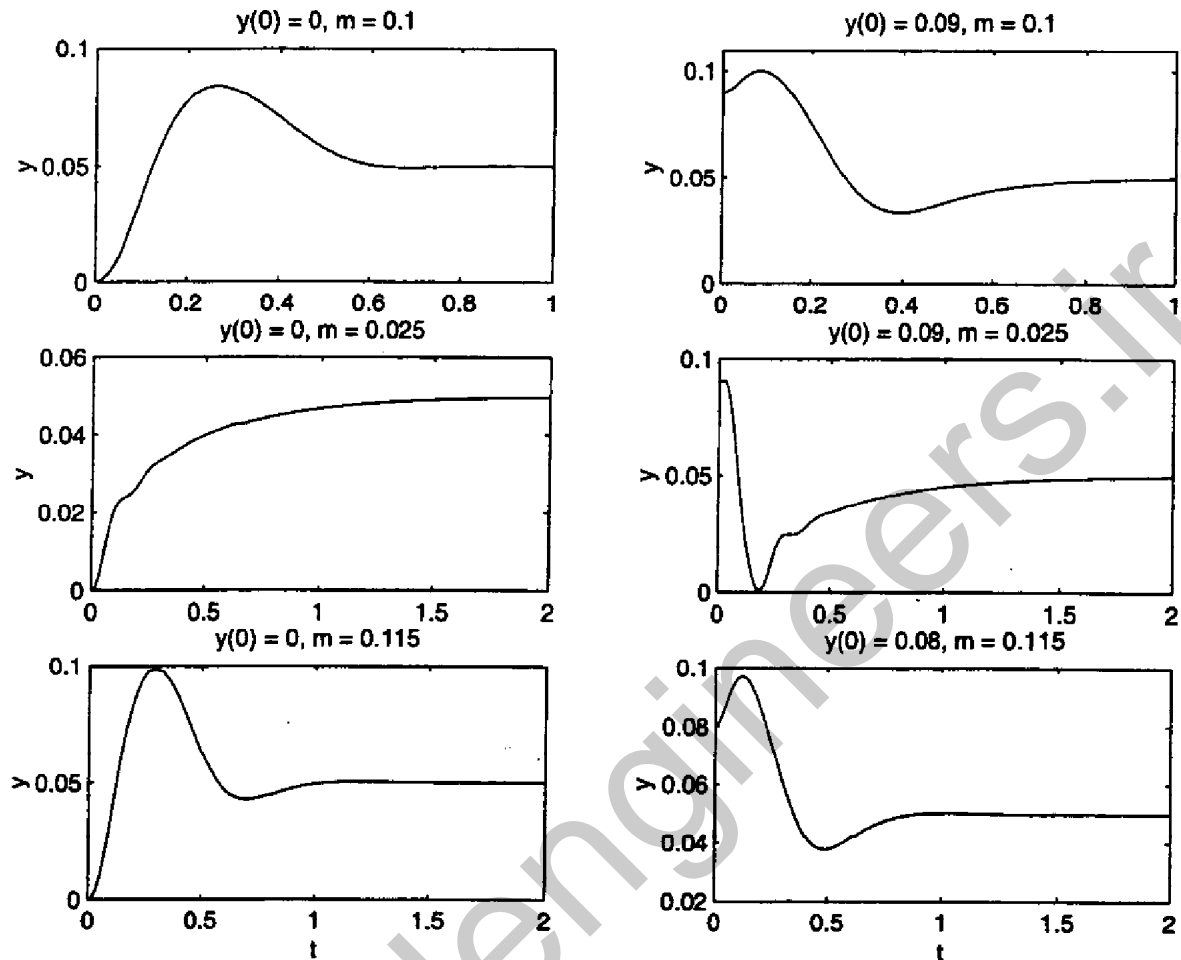

Figure 12.4: Exercise 12.8.

Linear interpolation does not guarantee that  $K_r$  will stabilize the system at the corresponding value of  $r$ . Therefore, we calculate the closed-loop eigenvalues for  $r = 0.03, 0.035, 0.04, 0.045, 0.05, 0.055, 0.06, 0.065,$  and  $0.07$ . The eigenvalues, plotted in Figure 12.5, indeed lie in the neighborhood of the desired eigenvalues. By the continuous dependence of the eigenvalues of a matrix on its parameters, we expect the same to be true for other values of  $r$ . For the observer, we solve the pole placement problem at  $r = 0.03, 0.05,$  and  $0.07$  to assign the eigenvalues of  $(A - HC)$  at  $-20, -20 \pm j20$ . The resulting observer gains are

$$H_{03} = \begin{bmatrix} 2.1700 & 2.5357 \\ 248.8284 & 49.4564 \\ 2.5357 & 1.7247 \end{bmatrix}, \quad H_{05} = \begin{bmatrix} 2.2405 & 3.0131 \\ 201.2620 & 60.2870 \\ 3.0131 & -0.2505 \end{bmatrix}, \quad H_{07} = \begin{bmatrix} 2.3229 & 3.4876 \\ 170.2966 & 70.7955 \\ 3.4876 & -1.7122 \end{bmatrix}$$

We use linear interpolation to determine  $H$  for other values of  $r$ :

$$H_r = H_{03} + \left( \frac{r - 0.03}{0.02} \right) (H_{05} - H_{03}), \quad \text{for } 0.03 \leq r \leq 0.05$$

$$H_r = H_{05} + \left( \frac{r - 0.05}{0.02} \right) (H_{07} - H_{05}), \quad \text{for } 0.05 \leq r \leq 0.07$$

The observer eigenvalues are checked for  $r = 0.03, 0.035, 0.04, 0.045, 0.05, 0.055, 0.06, 0.065,$  and  $0.07.$  and

## 《非线性系统（第三版）》习题解答

plotted in Figure 12.5.

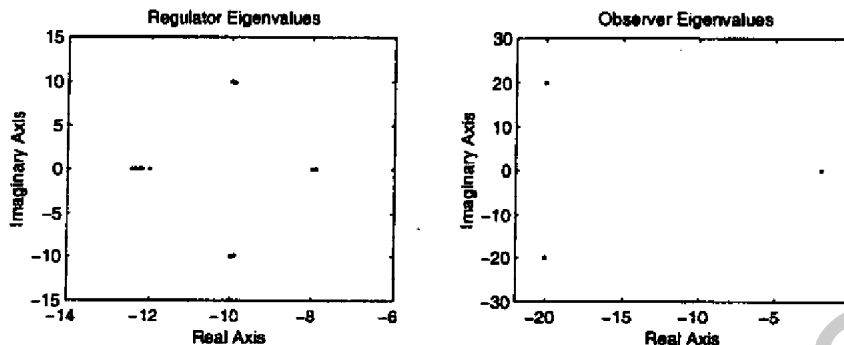

Figure 12.5: Exercise 12.8. Closed-loop eigenvalues for different values of  $r$ .

(1)  $y = x_3 = [0, 0, 1]x = Cx$ . It can be checked that  $(A, C)$  is observable. Thus, we can design a linear output feedback control law to stabilize the ball at  $y = r$ . We cannot design an integral controller because one of the conditions of integral control is that the controlled output ( $x_1$  in this case) should be measured.

• 12.9 (a) The equilibrium equations are

$$0 = -\theta_1 \bar{x}_1 - \theta_2 r u_{ss} + \theta_3, \quad 0 = -\theta_4 r + \theta_5 \bar{x}_1 u_{ss}$$

Substituting  $\bar{x}_1$  from the first equation into the second one, we obtain

$$u_{ss}^2 - a u_{ss} + b = 0, \quad \text{where } a = \frac{\theta_3}{\theta_2 r}, \quad b = \frac{\theta_1 \theta_4}{\theta_2 \theta_5}$$

$$r^2 < \frac{\theta_3^2 \theta_5}{4 \theta_1 \theta_2 \theta_4} \Rightarrow 4b < a^2$$

Hence, the quadratic equation has two real roots. To obtain the steady-state value of  $x_1$  in the range  $x_1 > \theta_3/2\theta_1$ , we choose the real root for which  $u_{ss} < a/2$ ; that is  $u_{ss} = (1/2) [a - \sqrt{a^2 - 4b}]$ . Linearization

at the chosen equilibrium point results in the matrix  $A = \begin{bmatrix} -\theta_1 & -\theta_2 u_{ss} \\ \theta_5 u_{ss} & -\theta_4 \end{bmatrix}$ . It can be verified that  $A$  is Hurwitz. Therefore, the equilibrium point is exponentially stable.

(b) The maximum value of  $r$  is  $\sqrt{(\theta_3^2 \theta_5 / 4 \theta_1 \theta_2 \theta_4)} = 298.14$ . We simulated the step response for increasing values of  $r$  in the range  $0 \leq r \leq 298$  and with initial conditions  $x_1(0) = \theta_3/\theta_1 = 0.6667$  and  $x_2(0) = 0$ . The motor always reached steady state at the desired speed, without  $x_1$  violating the constraint  $x_1 > \theta_3/2\theta_1 = 0.3333$ .

(c) Changes in the rotor inertial change the constants  $\theta_4$  and  $\theta_5$ , which are inversely proportional to the moment of inertia. It is clear, however, that multiplying  $\theta_4$  and  $\theta_5$  by the same constant does not affect the steady-state calculation. Simulation confirmed that the motor always reached steady state at the desired speed for  $0 \leq r \leq 298$ .

(d) Linearization at the desired equilibrium point results in the pair  $(A, B)$  where  $A$  is given in part (a) and  $B = \begin{bmatrix} -\theta_2 y_r \\ \theta_5 \bar{x}_1 \end{bmatrix}$ . The controlled output is  $y = x_2 \Rightarrow C = [0, 1]$ .

$$\text{rank} \begin{bmatrix} A & B \\ C & 0 \end{bmatrix} = \text{rank} \begin{bmatrix} -\theta_1 & -\theta_2 u_{ss} & -\theta_2 r \\ \theta_5 u_{ss} & -\theta_4 & \theta_5 \bar{x}_1 \\ 0 & 1 & 0 \end{bmatrix}$$

The determinant of this  $3 \times 3$  matrix is given by

$$\det(\cdot) = \theta_1 \theta_5 \bar{x}_1 - \theta_2 \theta_5 u_{ss} r = \theta_5 (\theta_3 - 2\theta_2 u_{ss} r)$$

## 《非线性系统（第三版）》习题解答

Substituting for  $u_{ss}$ , using its expression from part (a), we obtain  $\det(\cdot) = \theta_5 \theta_2 r \sqrt{a^2 - 4b} \neq 0$ . Therefore, the rank condition (12.23) is satisfied. It can be also verified that  $(A, B)$  is controllable. Now Set  $\mathcal{A} = \begin{bmatrix} A & 0 \\ C & 0 \end{bmatrix}$ ,  $\mathcal{B} = \begin{bmatrix} B \\ 0 \end{bmatrix}$  and proceed to design  $K$  such that  $\mathcal{A} - \mathcal{B}K$  is Hurwitz, using any pole placement algorithm.

(e) It can be verified that  $(A, C)$  is observable. Design  $H$  such that  $A - HC$  is Hurwitz and use an observer-based controller.

• 12.10 (a)

$$\begin{aligned}
 \dot{x}_1 &= x_2 \\
 \dot{x}_2 &= \ddot{\theta} = \frac{1}{\Delta(\theta)} \left[ (m+M)mgL \sin \theta - mL \cos \theta (F + mL\dot{\theta}^2 \sin \theta - k\dot{y}) \right] \\
 &= \frac{1}{\Delta(x_1)} \left[ (m+M)mgL \sin x_1 - mL \cos x_1 (u + mLx_2^2 \sin x_1 - kx_4) \right] \\
 \dot{x}_3 &= x_4 \\
 \dot{x}_4 &= \ddot{y} = \frac{1}{\Delta(\theta)} \left[ -m^2L^2g \sin \theta \cos \theta + (I + mL^2)(F + mL\dot{\theta}^2 \sin \theta - k\dot{y}) \right] \\
 &= \frac{1}{\Delta(x_1)} \left[ -m^2L^2g \sin x_1 \cos x_1 + (I + mL^2)(u + mLx_2^2 \sin x_1 - kx_4) \right]
 \end{aligned}$$

(b) Set  $u = 0$  and  $\dot{x}_i = 0$ .

$$\begin{aligned}
 0 &= \bar{x}_2 \\
 0 &= (m+M)mgL \sin \bar{x}_1 - mL \cos \bar{x}_1 (mL\bar{x}_2^2 \sin \bar{x}_1 - k\bar{x}_4) \\
 0 &= \bar{x}_4 \\
 0 &= -m^2L^2g \sin \bar{x}_1 \cos \bar{x}_1 + (I + mL^2)(mL\bar{x}_2^2 \sin \bar{x}_1 - k\bar{x}_4)
 \end{aligned}$$

The equilibrium points are given by  $(\bar{x}_1, 0, \bar{x}_3, 0)$  where  $\bar{x}_1 = 0, \pm\pi, \dots$ , and  $\bar{x}_3$  is arbitrary.

(c) Take  $\bar{x}_1 = 0$ . Linearization at  $x = \bar{x}$  and  $u = 0$  results in the matrix

$$\begin{bmatrix} 0 & 1 & 0 & 0 \\ c_1 & 0 & 0 & c_2 \\ 0 & 0 & 0 & 1 \\ -c_3 & 0 & 0 & -c_4 \end{bmatrix}$$

where the positive constants  $c_1$  to  $c_4$  are given by

$$c_1 = \frac{(m+M)mgL}{\Delta(0)}, \quad c_2 = \frac{mLk}{\Delta(0)}, \quad c_3 = \frac{m^2L^2g}{\Delta(0)}, \quad c_4 = \frac{k(I+mL^2)}{\Delta(0)}$$

The characteristic equation is given by

$$s [s^3 + c_4s^2 - c_1s + c_2c_3 - c_1c_4] = 0$$

From the Routh-Hurwitz criterion, we can see that the matrix has eigenvalues in the right-half plane. Hence, the equilibrium point is unstable.

(d) The linearized system is given by

$$\dot{x}_\delta = Ax_\delta + Bu_\delta$$

where  $x_\delta = x - \bar{x}$ ,  $u_\delta = u$ ,  $A$  is given in part (c) and  $B = [0, -mL/\Delta(0), 0, (I+mL^2)/\Delta(0)]^T$ . It can be verified that  $(A, B)$  is controllable. Proceed to design  $K$  to stabilize the matrix  $(A + BK)$  using any pole placement algorithm.

## 《非线性系统（第三版）》习题解答

### Chapter 13

• 13.1 (1)

$$\begin{aligned}
 y &= x_1 \\
 \dot{y} &= x_2 \\
 \ddot{y} &= -a[(1+x_3)\sin(x_1+\delta) - \sin\delta] - bx_2 \\
 y^{(3)} &= -a(1+x_3)\cos(x_1+\delta) \cdot x_2 - b\{-a[(1+x_3)\sin(x_1+\delta) - \sin\delta] - bx_2\} \\
 &\quad - a\sin(x_1+\delta)\{-cx_3 + d[\cos(x_1+\delta) - \cos\delta] + u\}
 \end{aligned}$$

Let  $D_0 = \{x \in R^3 \mid 0 < x_1 + \delta < \pi\}$ . The system has relative degree 3 in  $D_0$ . It is transformed into the normal form via the change of variables

$$T(x) = \begin{bmatrix} x_1 \\ x_2 \\ -a[(1+x_3)\sin(x_1+\delta) - \sin\delta] - bx_2 \end{bmatrix}$$

which is invertible in  $D_0$ .

(2)

$$\begin{aligned}
 y &= x_1 + \gamma x_2 \\
 \dot{y} &= x_2 + \gamma\{-a[(1+x_3)\sin(x_1+\delta) - \sin\delta] - bx_2\} \\
 \ddot{y} &= -\gamma a(1+x_3)\cos(x_1+\delta) \cdot x_1 + (1-b\gamma)x_2 - \gamma a\sin(x_1+\delta) \cdot x_3 \\
 &= -\gamma a x_2(1+x_3)\cos(x_1+\delta) + (1-b\gamma)\{-a[(1+x_3)\sin(x_1+\delta) - \sin\delta] - bx_2\} \\
 &\quad - \gamma a\sin(x_1+\delta)\{-cx_3 + d[\cos(x_1+\delta) - \cos\delta] + u\}
 \end{aligned}$$

The system has relative degree 2 in  $D_0$ . We have

$$h(x) = x_1 + \gamma x_2, \quad L_f h(x) = x_2 + \gamma\{-a[(1+x_3)\sin(x_1+\delta) - \sin\delta] - bx_2\}$$

Find  $\phi(x)$  such that  $[\partial\phi/\partial x]g = 0$  and  $T(x) = \begin{bmatrix} \phi(x) \\ h(x) \\ L_f h(x) \end{bmatrix}$  is invertible in  $D_0$ . It can be verified that

$\phi(x) = x_1$  meets these conditions. With  $\eta = \phi(x)$ , we have

$$\dot{\eta} = \dot{x}_1 = x_2 = (\xi_1 - \eta)/\gamma$$

$$y(t) \equiv 0 \Rightarrow \xi_1(t) \equiv 0 \Rightarrow \dot{\eta} = -(1/\gamma)\eta$$

The system is minimum phase if  $\gamma > 0$ .

## 《非线性系统（第三版）》习题解答

• 13.2 (a)

$$y = x_3 \Rightarrow \dot{y} = -x_1 + u$$

The system has relative degree 1 in  $R^3$ . Therefore, it is input-output linearizable.

(b)  $h(x) = x_3$ . Find  $\phi_1(x)$  and  $\phi_2(x)$  such that  $[\partial\phi_1/\partial x]g = 0$ ,  $[\partial\phi_2/\partial x]g = 0$ , and  $T(x) = \begin{bmatrix} \phi_1(x) \\ \phi_2(x) \\ h(x) \end{bmatrix}$  is invertible in  $R^3$ .  $\phi_1$  and  $\phi_2$  must satisfy

$$\frac{\partial\phi_1}{\partial x_2} + \frac{\partial\phi_1}{\partial x_3} = 0, \quad \frac{\partial\phi_2}{\partial x_2} + \frac{\partial\phi_2}{\partial x_3} = 0$$

Take  $\phi_1 = x_1$  and  $\phi_2 = x_2 - x_3$ , to obtain

$$T(x) = \begin{bmatrix} x_1 \\ x_2 - x_3 \\ x_3 \end{bmatrix} = \begin{bmatrix} 1 & 0 & 0 \\ 0 & 1 & -1 \\ 0 & 0 & 1 \end{bmatrix} x$$

$T(x)$  is a global diffeomorphism. The normal form is given by

$$\dot{\eta}_1 = -\eta_1 + \eta_2, \quad \dot{\eta}_2 = \eta_1 - \eta_2 - \xi - \eta_1\xi, \quad \dot{\xi} = -\eta_1 + u$$

The zero dynamics are

$$\dot{\eta} = \begin{bmatrix} -1 & 1 \\ 1 & -1 \end{bmatrix} \eta$$

The origin is stable but not asymptotically stable. Therefore, the system is not minimum phase.

• 13.3

$$\ddot{\theta} = \frac{1}{\Delta(\theta)} \left[ (m + M)mgL \sin\theta - mL \cos(\theta)(u + mL\dot{\theta}^2 \sin\theta - ky) \right]$$

The system has relative degree 2 in the domain  $\{|\theta| < \pi/2\}$ . Therefore, it is input-output linearizable. To find the zero dynamics, take  $\theta(t) \equiv 0$ .

$$\theta(t) \equiv 0 \Rightarrow \dot{\theta}(t) \equiv 0 \Rightarrow \ddot{\theta}(t) \equiv 0 \Rightarrow u(t) - ky(t) \equiv 0$$

Thus, the zero dynamics are given by  $\dot{y} = 0$ . The origin is stable but not asymptotically stable. Therefore, the system is not minimum phase.

• 13.4

$$\dot{x}_1 = \tan x_1 + x_2, \quad \dot{x}_2 = x_1 + u, \quad y = x_2$$

$$\dot{y} = x_1 + u$$

The system has relative degree 1 in  $R^2$ . Therefore, it is input-output linearizable. To find the zero dynamics, take  $y(t) \equiv 0$ . The zero dynamics are given by  $\dot{x}_1 = \tan x_1$ . The origin is unstable. Therefore, the system is not minimum phase.

• 13.5 For  $\phi_i = \zeta_i$ ,  $1 \leq i \leq m-1$ , the PDE (13.26) is clearly satisfied since  $\phi_i$  is independent of  $\zeta_m$  and  $\xi_n$ . For  $\phi_m = \zeta_m - \xi_n/q(x)$ , we have

$$\frac{\partial\phi_m}{\partial\zeta_m} + \frac{\partial\phi_m}{\partial\xi_n}q(x) = 1 - q(x)/q(x) = 0$$



## 《非线性系统（第三版）》习题解答

• 13.6 Taking  $x_i = \omega_i$  for  $i = 1, 2, 3$ , the state equation is given by  $\dot{x} = J^{-1}[u - \alpha(x)]$ , where  $J = \text{diag}[J_1, J_2, J_2]$  and  $\alpha(x) = - \begin{bmatrix} (J_2 - J_3)x_2x_3 \\ (J_3 - J_1)x_3x_1 \\ (J_1 - J_2)x_1x_2 \end{bmatrix}$ . The matrix  $J$  is nonsingular. This system is in the form (13.6) with  $A = 0$ ,  $B = J^{-1}$ . The pair  $(A, B)$  is controllable. Therefore, the system is feedback linearizable.

• 13.7

$$M(q)\ddot{q} + C(q, \dot{q})\dot{q} + D\dot{q} + g(q) = u$$

Let  $x_1 = q$ ,  $x_2 = \dot{q}$ , and  $x = \begin{bmatrix} x_1 \\ x_2 \end{bmatrix}$ . Then

$$\dot{x} = Ax + B\gamma(x)[u - \alpha(x)]$$

where

$$A = \begin{bmatrix} 0 & I \\ 0 & 0 \end{bmatrix}, \quad B = \begin{bmatrix} 0 \\ I \end{bmatrix}, \quad \gamma(x) = M^{-1}(x_1), \quad \alpha(x) = C(x_1, x_2)x_2 + Dx_2 + g(x_1)$$

The inertia matrix  $M(x_1)$  is nonsingular by assumption. The pair  $(A, B)$  is controllable. The system takes the form (13.6) of the text; hence it is feedback linearizable.

• 13.8 Let  $\lambda = [f, g]$ .

$$L_\lambda h = \frac{\partial h}{\partial x} \lambda = \frac{\partial h}{\partial x} \left[ \frac{\partial g}{\partial x} f - \frac{\partial f}{\partial x} g \right]$$

$$\begin{aligned} L_f L_g h(x) - L_g L_f h(x) &= L_f \left( \frac{\partial h}{\partial x} g \right) - L_g \left( \frac{\partial h}{\partial x} f \right) \\ &= \frac{\partial h}{\partial x} \frac{\partial g}{\partial x} f + g^T \frac{\partial^2 h}{\partial x^2} f - \frac{\partial h}{\partial x} \frac{\partial f}{\partial x} g - f^T \frac{\partial^2 h}{\partial x^2} g \\ &= \frac{\partial h}{\partial x} \frac{\partial g}{\partial x} f - \frac{\partial h}{\partial x} \frac{\partial f}{\partial x} g = L_\lambda h \end{aligned}$$

where we have used the property that the Hessian matrix  $\frac{\partial^2 h}{\partial x^2}$  is symmetric.

• 13.9 Necessity follows from the fact that  $f_1$  to  $f_r$  are vector fields of  $\Delta$ . To prove sufficiency, let  $g_1$  and  $g_2$  be any two vector fields of  $\Delta$ . Then, they can be expressed (locally) as

$$g_1(x) = \sum_{i=1}^r c_i(x) f_i(x), \quad g_2(x) = \sum_{i=1}^r d_i(x) f_i(x)$$

$$\begin{aligned} [g_1, g_2] &= \left[ \sum_{i=1}^r c_i f_i, \sum_{i=1}^r d_i f_i \right] \\ &= \frac{\partial}{\partial x} \left( \sum_{j=1}^r d_j f_j \right) \sum_{i=1}^r c_i f_i - \frac{\partial}{\partial x} \left( \sum_{i=1}^r c_i f_i \right) \sum_{j=1}^r d_j f_j \\ &= \sum_{j=1}^r d_j \frac{\partial f_j}{\partial x} \sum_{i=1}^r c_i f_i + \sum_{j=1}^r f_j \frac{\partial d_j}{\partial x} \sum_{i=1}^r c_i f_i - \sum_{i=1}^r c_i \frac{\partial f_i}{\partial x} \sum_{j=1}^r d_j f_j - \sum_{i=1}^r f_i \frac{\partial c_i}{\partial x} \sum_{j=1}^r d_j f_j \\ &= \sum_{i=1}^r \sum_{j=1}^r \left\{ c_i d_j \left[ \frac{\partial f_j}{\partial x} f_i - \frac{\partial f_i}{\partial x} f_j \right] + c_i (L_{f_i} d_j) f_j - d_j (L_{f_j} c_i) f_i \right\} \\ &= \sum_{i=1}^r \sum_{j=1}^r \{ c_i d_j [f_i, f_j] + c_i (L_{f_i} d_j) f_j - d_j (L_{f_j} c_i) f_i \} \end{aligned}$$

## 《非线性系统（第三版）》习题解答

Since  $[f_i, f_j] \in \Delta$ , we conclude that  $[g_1, g_2] \in \Delta$ .

• 13.10

$$[f_1, f_2] = \begin{bmatrix} 0 & -e^{x_2} & 0 & 0 \\ 0 & 0 & 0 & 0 \\ 0 & 0 & 0 & 0 \\ 0 & 0 & 0 & 0 \end{bmatrix} \begin{bmatrix} x_1 \\ 1 \\ 0 \\ x_3 \end{bmatrix} - \begin{bmatrix} 1 & 0 & 0 & 0 \\ 0 & 0 & 0 & 0 \\ 0 & 0 & 0 & 0 \\ 0 & 0 & 1 & 0 \end{bmatrix} \begin{bmatrix} -e^{x_2} \\ 0 \\ 0 \\ 0 \end{bmatrix} = \begin{bmatrix} 0 \\ 0 \\ 0 \\ 0 \end{bmatrix}$$

Since  $[f_2, f_1] = -[f_1, f_2]$ , we conclude that  $\Delta$  is involutive.

• 13.11 (a)

$$\dot{y} = -3x_1^2 \dot{x}_1 + \dot{x}_2 = -3x_1^2(x_1 + x_2) + 3x_1^2 x_2 + x_1 + u = -3x_1^3 + x_1 + u$$

The system has relative degree 1 in  $R^2$ . Hence, it is input-output linearizable.

(b) Find  $\phi(x)$  such that  $(\partial\phi/\partial x)g = (\partial\phi/\partial x_2) = 0$  and  $T(x) = \begin{bmatrix} \phi(x) \\ -x_1^3 + x_2 \end{bmatrix}$  is a diffeomorphism. With  $\phi(x) = x_1$ ,  $T(x)$  is a global diffeomorphism. The change of variables

$$\eta = x_1, \quad \xi = -x_1^3 + x_2$$

transforms the system into the globally-defined normal form

$$\dot{\eta} = \eta + \eta^3 + \xi, \quad \dot{\xi} = -3\eta^3 + \eta + u$$

(c) The zero dynamics are  $\dot{\eta} = \eta + \eta^3$ . Hence, the system is not minimum phase.

(d)

$$f(x) = \begin{bmatrix} x_1 + x_2 \\ 3x_1^2 x_2 + x_1 \end{bmatrix}, \quad g = \begin{bmatrix} 0 \\ 1 \end{bmatrix}$$

$$ad_f g = -\frac{\partial f}{\partial x} g = \begin{bmatrix} 1 & 1 \\ 6x_1 x_2 + 1 & 3x_1^2 \end{bmatrix} \begin{bmatrix} 0 \\ 1 \end{bmatrix} = \begin{bmatrix} 1 \\ 3x_1^2 \end{bmatrix}$$

$$G = [g \quad ad_f g] = \begin{bmatrix} 0 & 1 \\ 1 & 3x_1^2 \end{bmatrix}, \quad \det(G) = -1 \neq 0$$

Hence, the system is feedback linearizable.

(e) Find  $h(x)$  such that  $L_g h = 0$  and  $L_g L_f h \neq 0$ . It can be verified that  $h(x) = x_1$  satisfies these conditions and results in the global diffeomorphism  $T(x) = \begin{bmatrix} x_1 \\ x_1 + x_2 \end{bmatrix}$ . The transformed system is

$$\dot{z}_1 = z_2, \quad \dot{z}_2 = z_2 + 3z_1^2(z_2 - z_1) + z_1 + u$$

$u = -z_1 - z_2 - 3z_1^2(z_2 - z_1)$  yields

$$\dot{z}_1 = z_2, \quad \dot{z}_2 = v$$

• 13.12 (a)

$$y = x_1 + x_2$$

$$\dot{y} = \dot{x}_1 + \dot{x}_2 = -x_1 + x_1 x_2 + x_2 + x_3$$

$$\ddot{y} = (-1 + x_2)\dot{x}_1 + (x_1 + 1)\dot{x}_2 + \dot{x}_3 = (-1 + x_2)(-x_1 + x_1 x_2) + (x_1 + 1)(x_2 + x_3) + \delta(x) + u$$

The system has relative degree 2 in  $R^3$ . Hence, it is input-output linearizable.

(b) Find  $\phi(x)$  such that  $(\partial\phi/\partial x)g = (\partial\phi/\partial x_3) = 0$  and  $T(x) = \begin{bmatrix} \phi(x) \\ x_1 + x_2 \\ -x_1 + x_1 x_2 + x_2 + x_3 \end{bmatrix}$  is a diffeomorphism. With  $\phi(x) = x_1$ ,  $T(x)$  is a global diffeomorphism. The change of variables

$$\eta = x_1, \quad \xi_1 = x_1 + x_2, \quad \xi_2 = -x_1 + x_1 x_2 + x_2 + x_3$$

## 《非线性系统（第三版）》习题解答

transforms the system into the globally-defined normal form

$$\dot{\eta} = -\eta + \eta(\xi_1 - \eta), \quad \dot{\xi}_1 = \xi_2, \quad \dot{\xi}_3 = (-1 + x_2)(-x_1 + x_1 x_2) + (x_1 + 1)(x_2 + x_3) + \delta(x) + u$$

(c)

$$y(t) \equiv 0 \Rightarrow \xi_1(t) \equiv 0 \text{ and } \xi_2(t) \equiv 0 \Rightarrow \dot{\eta} = -\eta - \eta^2$$

The origin of the zero dynamics is asymptotically stable. Hence, the system is minimum phase.

(d)

$$ad_f g = [f, g] = - \begin{bmatrix} -1+x_2 & x_1 & 0 \\ 0 & 1 & 1 \\ * & * & (\partial\delta/\partial x_3) \end{bmatrix} \begin{bmatrix} 0 \\ 0 \\ 1 \end{bmatrix} = \begin{bmatrix} 0 \\ -1 \\ -(\partial\delta/\partial x_3) \end{bmatrix}$$

$$[g, ad_f g] = \begin{bmatrix} 0 & 0 & 0 \\ 0 & 0 & 0 \\ * & * & -(\partial^2\delta/\partial x_3^2) \end{bmatrix} \begin{bmatrix} 0 \\ 0 \\ 1 \end{bmatrix} = \begin{bmatrix} 0 \\ 0 \\ -(\partial^2\delta/\partial x_3^2) \end{bmatrix} = -(\partial^2\delta/\partial x_3^2)g$$

Hence, the distribution  $\{g, ad_f g\}$  is involutive.

$$ad_f^2 g = [f, ad_f g] = \begin{bmatrix} 0 & 0 & 0 \\ 0 & 0 & 0 \\ * & * & * \end{bmatrix} \begin{bmatrix} f_1 \\ f_2 \\ \delta \end{bmatrix} - \begin{bmatrix} -1+x_2 & x_1 & 0 \\ 0 & 1 & 1 \\ * & * & * \end{bmatrix} \begin{bmatrix} 0 \\ -1 \\ -(\partial\delta/\partial x_3) \end{bmatrix} = \begin{bmatrix} x_1 \\ * \\ * \end{bmatrix}$$

$$G = \begin{bmatrix} 0 & 0 & x_1 \\ 0 & -1 & * \\ 1 & * & * \end{bmatrix}, \quad \det(G) = x_1$$

Hence, the system is feedback linearizable in the domain  $\{x_1 > 0\}$  or the domain  $\{x_1 < 0\}$ .

(e) Find  $h(x)$  such that

$$L_g h = 0, \quad L_g L_f h = 0, \quad L_g L_f^2 h \neq 0$$

$$L_g h = \frac{\partial h}{\partial x_3} = 0 \Rightarrow h = h(x_1, x_2)$$

$$L_f h = \frac{\partial h}{\partial x_1}(-x_1 + x_1 x_2) + \frac{\partial h}{\partial x_2}(x_2 + x_3)$$

$$L_g L_f h = \frac{\partial(L_f h)}{\partial x_3} = 0 \Rightarrow \frac{\partial h}{\partial x_2} = 0$$

Take  $h(x) = x_1$ . It can be verified that  $T(x) = \begin{bmatrix} x_1 \\ -x_1 + x_1 x_2 \\ (-1 + x_2)^2 x_1 + x_1(x_2 + x_3) \end{bmatrix}$  is a diffeomorphism in the domain  $\{x_1 > 0\}$  or the domain  $\{x_1 < 0\}$ . The transformed system is

$$\dot{z}_1 = z_2, \quad \dot{z}_2 = z_3, \quad \dot{z}_3 = x_1[u - \alpha(x)]$$

Take  $u = \alpha(x) + v/x_1$ .

• 13.13 Restrict  $u$  to the domain  $|u| < \pi/2$  and  $x$  to the domain  $D = \{|x_2| < \pi/2, |x_3| < \pi/2\}$ . Then,  $\cos(x_2) \neq 0, \cos(x_3) \neq 0$ , and  $\tan(u)$  is invertible. Apply the input transformation  $w = \tan(u)/(b \cos(x_2) \cos(x_3))$ , to obtain

$$\dot{x} = f(x) + gw$$

where

$$f = \begin{bmatrix} \tan(x_3) \\ -\tan(x_2)/(a \cos(x_3)) \\ \tan(x_2)/(a \cos(x_3)) \end{bmatrix}, \quad g = \begin{bmatrix} 0 \\ 1 \\ 0 \end{bmatrix}$$

## 《非线性系统（第三版）》习题解答

$$ad_f g = [f, g] = -\frac{\partial f}{\partial x} g = \begin{bmatrix} 0 \\ \partial f_2 / \partial x_2 \\ -\partial f_2 / \partial x_2 \end{bmatrix}, \quad [g, ad_f g] = \frac{\partial(ad_f g)}{\partial x} g = \begin{bmatrix} 0 \\ \partial^2 f_2 / \partial x_2^2 \\ -\partial^2 f_2 / \partial x_2^2 \end{bmatrix}$$

Since  $\partial f_2 / \partial x_2 = -\sec^2(x_2) / (a \cos(x_3)) \neq 0$  in  $D$ , we have

$$[g, ad_f g] = \frac{\partial^2 f_2 / \partial x_2^2}{\partial f_2 / \partial x_2} ad_f g$$

Therefore, the distribution  $\{g, ad_f g\}$  is involutive.

$$ad_f^2 g = [f, ad_f g] = \frac{\partial(ad_f g)}{\partial x} f - \frac{\partial f}{\partial x} ad_f g = \begin{bmatrix} (\partial f_1 / \partial x_3)(\partial f_2 / \partial x_2) \\ * \\ * \end{bmatrix}$$

$$\mathcal{G} = [g, ad_f g, ad_f^2 g] = \begin{bmatrix} 0 & 0 & (\partial f_1 / \partial x_3)(\partial f_2 / \partial x_2) \\ 1 & (\partial f_2 / \partial x_2) & * \\ 0 & -(\partial f_2 / \partial x_2) & * \end{bmatrix}$$

$$\det(\mathcal{G}) = -(\partial f_1 / \partial x_3)(\partial f_2 / \partial x_2)^2$$

Since  $\partial f_1 / \partial x_3 = -\sec^2(x_3) \neq 0$  in  $D$ ,  $\det(\mathcal{G}) \neq 0$  in  $D$ . Thus, the system is feedback linearizable. To find the domain of validity of the linear model, we need to find  $h(x)$  such that

$$h(0) = 0, \quad \frac{\partial h}{\partial x} g = 0, \quad \frac{\partial(L_f h)}{\partial x} g = 0, \quad \frac{\partial(L_f^2 h)}{\partial x} g \neq 0$$

$$\frac{\partial h}{\partial x} g = 0 \Rightarrow \frac{\partial h}{\partial x_2} = 0$$

We must take  $h$  independent of  $x_2$ . With  $(\partial h / \partial x_2) = 0$ , we have

$$L_f h = \frac{\partial h}{\partial x_1} \tan(x_3) + \frac{\partial h}{\partial x_3} \frac{\tan(x_2)}{a \cos(x_3)}$$

$$\frac{\partial(L_f h)}{\partial x} g = 0 \Rightarrow \frac{\partial(L_f h)}{\partial x_2} = 0 \Rightarrow \frac{\partial h}{\partial x_3} \frac{(\sec x_2)^2}{a \cos(x_3)} = 0 \Rightarrow \frac{\partial h}{\partial x_3} = 0$$

So, we choose  $h$  independent of  $x_3$ . Therefore,

$$L_f h = \frac{\partial h}{\partial x_1} \tan(x_3) \quad \text{and} \quad L_f^2 h = \frac{\partial^2 h}{\partial x_1^2} (\tan x_3)^2 + \frac{\partial h}{\partial x_1} \frac{(\sec x_3)^2 \tan(x_2)}{a \cos(x_3)}$$

$$\frac{\partial(L_f^2 h)}{\partial x} g = \frac{\partial h}{\partial x_1} \frac{(\sec x_3)^2 (\sec x_2)^2}{a \cos(x_3)} \neq 0$$

We must require

$$\frac{\partial h}{\partial x_1} \neq 0$$

Take  $h = x_1$ , which yields

$$L_f h = \tan x_3, \quad L_f^2 h = (1/a)(\sec x_3)^3 \tan x_2$$

The domain of validity of the linear model is  $x \in D$  and  $u \in \{ |u| < \pi/2 \}$ .

## 《非线性系统（第三版）》习题解答

• 13.14 (a)

$$f = \begin{bmatrix} -x_1 + x_2 - x_3 \\ -x_1 x_3 - x_2 \\ -x_1 \end{bmatrix}, \quad g = \begin{bmatrix} 0 \\ 1 \\ 1 \end{bmatrix}$$

$$ad_f g = [f, g] = -\frac{\partial f}{\partial x} g = \begin{bmatrix} 0 \\ 1 + x_1 \\ 0 \end{bmatrix}, \quad [g, ad_f g] = \frac{\partial(ad_f g)}{\partial x} g = \begin{bmatrix} 0 \\ 0 \\ 0 \end{bmatrix}$$

Therefore, the distribution  $\{g, ad_f g\}$  is involutive.

$$ad_f^2 g = [f, ad_f g] = \frac{\partial(ad_f g)}{\partial x} f - \frac{\partial f}{\partial x} ad_f g = \begin{bmatrix} -(1 + x_1) \\ 1 + x_2 - x_3 \\ 0 \end{bmatrix}$$

$$\mathcal{G} = [g, ad_f g, ad_f^2 g] = \begin{bmatrix} 0 & 0 & -(1 + x_1) \\ 1 & 1 + x_1 & 1 + x_2 - x_3 \\ 1 & 0 & 0 \end{bmatrix}, \quad \det(\mathcal{G}) = (1 + x_1)^2$$

Thus, the system is feedback linearizable in the set  $\{1 + x_1 \neq 0\}$ .

(b) Find  $h$  that satisfies

$$h(0) = 0, \quad \frac{\partial h}{\partial x} g = 0, \quad \frac{\partial(L_f h)}{\partial x} g = 0, \quad \frac{\partial(L_f^2 h)}{\partial x} g \neq 0$$

$$\frac{\partial h}{\partial x} g = 0 \Rightarrow \frac{\partial h}{\partial x_2} + \frac{\partial h}{\partial x_3} = 0$$

Try  $h = x_1$ . Then,  $L_f h = -x_1 + x_2 - x_3$ ,

$$\frac{\partial(L_f h)}{\partial x} g = 0$$

$$L_f^2 h = -(-x_1 + x_2 - x_3) + (-x_1 x_3 - x_2) + x_1 = 2x_1 - 2x_2 + x_3 - x_1 x_3$$

$$\frac{\partial(L_f^2 h)}{\partial x} g = -2 + 1 - x_1 = -(1 + x_1)$$

Restrict  $x$  to the domain  $\{1 + x_1 > 0\}$ . Thus, the transformation  $T(x)$  is given by

$$T(x) = \begin{bmatrix} x_1 \\ -x_1 + x_2 - x_3 \\ 2x_1 - 2x_2 + x_3 - x_1 x_3 \end{bmatrix}$$

A linearizing state feedback control is given by

$$u = \alpha(x) + \beta(x)v$$

where  $\beta = -1/(1 + x_1)$  and  $\alpha$  can be calculated using (13.36) of the text.

• 13.15

$$z = T(x) = \begin{bmatrix} \theta x_2^2 + c x_3^2 + c_2 \\ 2\theta x_2(k - b x_2) \\ 2\theta(k - 2b x_2)(-b x_2 + k - c x_1 x_3) \end{bmatrix}$$

Clearly  $T(x)$  is differentiable. Find  $T^{-1}(z)$ . Start with the equation

$$z_2 = 2\theta x_2(k - b x_2)$$

## 《非线性系统（第三版）》习题解答

For  $x_2 < k/2b$ , this equation has a unique solution  $x_2 = \phi(z_2)$ . Consider next the equation

$$z_1 = \theta x_2^2 + cx_3^2 + c_2$$

which yields

$$x_3 = \sqrt{\frac{1}{c}[z_1 - \theta\phi^2(z_2) - c_2]} \stackrel{\text{def}}{=} \psi(z_1, z_2) > 0, \quad \text{in } T(D_0)$$

The last equation is

$$z_3 = 2\theta(k - 2bx_2)(-bx_2 + k - cx_1x_2)$$

Since  $(k - 2bx_2) > 0$  and  $x_3 > 0$  in  $D_0$ , this equation uniquely determines  $x_1$  as a function of  $z_1, z_2$  and  $z_3$ . Thus the map  $T^{-1}(z)$  is well defined on  $T(D_0)$ . It can be easily checked that  $T^{-1}(z)$  is differentiable in  $T(D_0)$ .

• 13.16

$$\dot{x}_1 = x_2, \quad \dot{x}_2 = -10 \left[ \sin \left( x_1 + \frac{\pi}{4} \right) - \frac{1}{\sqrt{2}} \right] + 10u$$

The state feedback control of Exercise 12.1 is

$$u = -2.5x_1 - x_2 \Rightarrow T = \frac{1}{\sqrt{2}} - 2.5(\theta - \pi/4) - \dot{\theta}$$

The closed-loop eigenvalues of the linearized model are  $-5 \pm 2.6591j$ . Using feedback linearization, we obtain the control law

$$u = \sin(x_1 + \delta) - \sin \delta - k_1x_1 - k_2x_2 \Rightarrow T = \sin \theta - k_1(\theta - \pi/4) - k_2\dot{\theta}$$

To assign the closed-loop eigenvalues at  $-5 \pm 2.6591j$ , we choose  $k_1 = 3.20711$  and  $k_2 = 1$ . Thus,

$$T = \sin \theta - 3.20711(\theta - \pi/4) - \dot{\theta}$$

Simulation of the two controllers, for different initial conditions, are shown in Figure 13.1. For the case of zero initial conditions, the responses are almost identical. For the initial condition  $\theta = 5\pi/4$  and  $\dot{\theta} = 0$ , there is a difference where  $\theta$  reaches steady state faster under feedback linearization, at the expense of more control effort and a larger transient of  $\dot{\theta}$ . The difference between the two controllers is not dramatic. We would have seen a more dramatic difference had the feedback gains been smaller, for then the control based on linearization would have produced a closed-loop system with multiple equilibria.

• 13.17

$$f = \begin{bmatrix} -x_1 + x_2 \\ x_1 - x_2 - x_1x_3 \\ x_1 + x_1x_2 - 2x_3 \end{bmatrix}, \quad g = \begin{bmatrix} 0 \\ 1 \\ 0 \end{bmatrix}$$

$$ad_f g = [f, g] = \begin{bmatrix} -1 \\ 1 \\ -x_1 \end{bmatrix}, \quad [g, ad_f g] = \begin{bmatrix} 0 \\ 0 \\ 0 \end{bmatrix}$$

Hence, the distribution  $\{g, ad_f g\}$  is involutive.

$$ad_f^2 g = [f, ad_f g] = \begin{bmatrix} -2 \\ 2 - x_3 - x_1^2 \\ 1 - 2x_1 \end{bmatrix}$$

《非线性系统（第三版）》习题解答

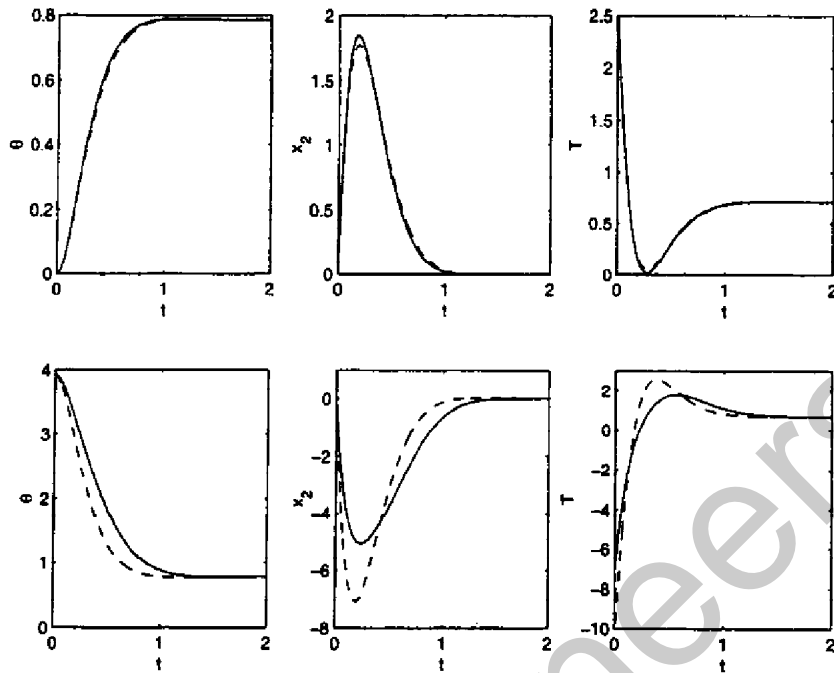

Figure 13.1: Exercise 13.16: Response under linearization (solid) and under feedback linearization (dashed).

$$G = \begin{bmatrix} 0 & -1 & -2 \\ 1 & 1 & * \\ 0 & -x_1 & 1 - 2x_1 \end{bmatrix}, \quad \det(G) = 1$$

Hence, the system is feedback linearizable. Find  $h(x)$  that satisfies

$$h(0) = 0, \quad \frac{\partial h}{\partial x} g = 0, \quad \frac{\partial(L_f h)}{\partial x} g = 0, \quad \frac{\partial(L_f^2 h)}{\partial x} g \neq 0$$

$$\frac{\partial h}{\partial x} g = 0 \Rightarrow \frac{\partial h}{\partial x_2} = 0 \Rightarrow h = h(x_1, x_3)$$

$$L_f h = \frac{\partial h}{\partial x} f = \frac{\partial h}{\partial x_1} (x_2 - x_1) + \frac{\partial h}{\partial x_3} (x_1 + x_1 x_2 - 2x_3)$$

$$\frac{\partial(L_f h)}{\partial x} g = 0 \Rightarrow \frac{\partial h}{\partial x_1} + x_1 \frac{\partial h}{\partial x_3} = 0$$

Try  $h = x_1^2 - 2x_3$ .

$$L_f h = 2x_1(x_2 - x_1) - 2(x_1 + x_1 x_2 - 2x_3) = -2(x_1^2 + x_1 - 2x_3)$$

$$L_f^2 h = \frac{\partial(L_f h)}{\partial x} f = -2(2x_1 + 1)(x_2 - x_1) + 4(x_1 + x_1 x_2 - 2x_3) = 4x_1^2 + 6x_1 - 2x_2 - 8x_3$$

$$\frac{\partial(L_f^2 h)}{\partial x} g = -2 \neq 0$$

It can be verified that

$$T(x) = \begin{bmatrix} x_1^2 - 2x_3 \\ -2(x_1^2 + x_1 - 2x_3) \\ 4x_1^2 + 6x_1 - 2x_2 - 8x_3 \end{bmatrix}$$

## 《非线性系统（第三版）》习题解答

is a global diffeomorphism. In particular,  $T^{-1}$  is given by

$$T^{-1}(z) = \begin{bmatrix} -z_1 - (1/2)z_2 \\ -z_1 - (3/2)z_2 - (1/2)z_3 \\ (1/2)z_1^2 - (1/2)z_1 + (1/2)z_1z_2 + (1/8)z_2^2 \end{bmatrix}$$

The transformed system is given by

$$\dot{z} = A_c z - 2B_c[u - \alpha(x)]$$

Design  $K$  such that  $A_c - B_c K$  is Hurwitz and take  $u = \alpha(x) + (1/2)Kz$ .

• 13.18 (a) The system is already in the form (13.1), with

$$A = \begin{bmatrix} 0 & 1 \\ 0 & 0 \end{bmatrix}, \quad B = \begin{bmatrix} 0 \\ 1 \end{bmatrix}, \quad \gamma(x) = -b \cos x_1, \quad \alpha(x) = \frac{a \sin x_1}{b \cos x_1}$$

Therefore, it is feedback linearizable provided  $\cos x_1 \neq 0$ , which is the case in the domain  $D = \{|x_1| < \pi/2\}$ .

(b) Take

$$u = -\frac{1}{b \cos x_1}(-a \sin x_1 + v)$$

to obtain

$$\dot{x}_1 = x_2, \quad \dot{x}_2 = v$$

To stabilize the system at  $x_1 = \theta$ , take

$$v = -k_1(x_1 - \theta) - k_2 x_2, \quad k_1 > 0, \quad k_2 > 0$$

The closed-loop system

$$\dot{x}_1 = x_2, \quad \dot{x}_2 = -k_1(x_1 - \theta) - k_2 x_2$$

has an asymptotically stable equilibrium point at  $x = (\theta, 0)$ . The domain of validity of this control is limited to  $|x_1| < \pi/2$ . Therefore, we cannot make the equilibrium point globally asymptotically stable.

• 13.19 The map  $T(x)$  is given in Example 13.14. Using (13.36), we can calculate  $\alpha(x)$  and  $\gamma(x)$ . These three functions depend on the parameters  $a$ ,  $b$ ,  $c$ , and  $d$ . Define  $\hat{T}(x)$ ,  $\hat{\alpha}(x)$ , and  $\hat{\gamma}(x)$  by replacing the parameters with their estimates, and set  $\hat{\beta}(x) = 1/\hat{\gamma}(x)$ . The state feedback control is given by  $u = \hat{\alpha}(x) - \hat{\beta}(x)K\hat{T}(x)$ . The closed-loop system can be represented by  $\dot{z} = (A_c - B_c K)z + B_c \delta(z)$ , where  $\delta(z)$  is defined in Section 13.4.1.

• 13.20 (a)

$$\dot{\eta} = f_0(\eta, \xi_1), \quad \dot{\xi} = A_c \xi + B_c \beta^{-1}(x)[u - \alpha(x)]$$

Take  $u = \alpha(x) + \beta(x)v$ , to obtain

$$\dot{\eta} = f_0(\eta, \xi_1), \quad \dot{\xi}_1 = \xi_2, \quad \dots \quad \dot{\xi}_{\rho-1} = \xi_\rho, \quad \dot{\xi}_\rho = v$$

Apply the change of variables  $z_i = \varepsilon^{(i-1)} \xi_i$  and  $w = \varepsilon^\rho v$ .

$$\begin{aligned} \varepsilon \dot{z}_1 &= \varepsilon \dot{\xi}_1 = \varepsilon \xi_2 = z_2 \\ \varepsilon \dot{z}_2 &= \varepsilon^2 \dot{\xi}_2 = \varepsilon^2 \xi_3 = z_3 \\ &\vdots \\ \varepsilon \dot{z}_{\rho-1} &= \varepsilon^{\rho-1} \dot{\xi}_{\rho-1} = \varepsilon^{\rho-1} \xi_\rho = z_\rho \\ \varepsilon \dot{z}_\rho &= \varepsilon^\rho \dot{\xi}_\rho = \varepsilon^\rho v = w \end{aligned}$$



## 《非线性系统（第三版）》习题解答

Thus,

$$\dot{\eta} = f_0(\eta, z_1), \quad \varepsilon \dot{z} = A_c z + B_c w$$

(b) With  $w = -Kz$ , we have

$$\dot{\eta} = f_0(\eta, z_1), \quad \varepsilon \dot{z} = (A_c - B_c K)z$$

Let  $V(\eta, z) = V_0(\eta) + \sqrt{z^T P z}$ .

$$\begin{aligned} \dot{V} &= \frac{\partial V_0}{\partial \eta} f_0(\eta, z_1) + \frac{1}{2\varepsilon \sqrt{z^T P z}} z^T [P(A_c - B_c K) + (A_c - B_c K)^T P] z \\ &= \frac{\partial V_0}{\partial \eta} f_0(\eta, 0) + \frac{\partial V_0}{\partial \eta} [f_0(\eta, z_1) - f_0(\eta, 0)] - \frac{1}{2\varepsilon \sqrt{z^T P z}} z^T z \end{aligned}$$

Let  $c$  be any positive constant and define the compact set  $\Omega$  by  $\Omega = \{V(\eta, z) \leq c\}$ . On the compact set  $\Omega$ , we have

$$\frac{\partial V_0}{\partial \eta} [f_0(\eta, z_1) - f_0(\eta, 0)] \leq k|\xi_1|$$

where  $k$  depends on  $c$ . Hence,

$$\dot{V} \leq -W(\eta) + k|z_1| - \frac{1}{2\varepsilon \sqrt{\lambda_{\min}(P)}} \|z\|_2 \leq -W(\eta) - \left( \frac{1}{2\varepsilon \sqrt{\lambda_{\min}(P)}} - k_1 \right) \|z\|_2$$

Choosing  $\varepsilon$  small enough, we obtain

$$\dot{V} \leq -W(\eta) - k_2 \|z\|_2, \quad k_2 > 0$$

which shows that, for sufficiently small  $\varepsilon$ , the origin is asymptotically stable and the set  $\Omega$  is contained in the region of attraction.

(c) Without loss of generality, take  $\varepsilon \leq 1$ . For any compact set in  $R^n$ , we have  $\|\eta_0\|_2 \leq c_1$  and  $\|\xi_0\|_2 \leq c_2$ . Then,  $\|z(0)\|_2 \leq \|\xi_0\|_2 \leq c_2$ . Choose  $c > 0$  such that  $\{\|\eta\|_2 \leq c_1 \text{ and } \|z\|_2 \leq c_2\} \subset \{V(\eta, z) \leq c\}$ . Then, initial states  $(\eta_0, \xi_0)$  in any compact set in  $R^n$  are included in the region of attraction. which shows that the feedback control achieves semiglobal stabilization.

(d) Notice that for any bounded  $\xi(0)$ , the initial state  $z(0)$  is bounded uniformly in  $\varepsilon$ . Therefore, the solution  $(\eta(t), z(t))$  is bounded uniformly in  $\varepsilon$ . However, peaking is present in  $\xi_2$  to  $\xi_\rho$ , as seen from the scaling transformation. There is no peaking  $\xi_1$  since  $\xi_1 = z_1$ . The function  $f_0$  depends only on  $z_1$ , which explains the special nature of the current system.

### • 13.21 (a)

$$y = x_1 - x_2 \Rightarrow \dot{y} = \dot{x}_1 - \dot{x}_2 = x_2 \Rightarrow \ddot{y} = \dot{x}_2 = x_1 x_2 - x_2^2 + u$$

Therefore, the system has relative degree 2 in  $R^3$ . We have  $h(x) = x_1 - x_2$  and  $L_f h(x) = x_2$ . Find  $\phi(x)$  such

that  $(\partial \phi / \partial x)g = 0$  and  $T(x) = \begin{bmatrix} \phi(x) \\ h(x) \\ L_f h(x) \end{bmatrix}$  is invertible. It can be verified that  $\phi(x) = x_1 - x_3$  satisfies the PDE and makes  $T(x)$  a global diffeomorphism. The normal form is given by

$$\dot{\eta} = -\eta^3 - \xi_1, \quad \dot{\xi}_1 = \xi_2, \quad \dot{\xi}_2 = \xi_1 \xi_2 + u, \quad y = \xi_1$$

This is a special normal form because the  $\dot{\eta}$ -equation depends only on  $\xi_1$ .

(b) The zero dynamics are given by  $\dot{\eta} = -\eta^3$ . The origin of this system is globally asymptotically stable.

(c) Taking  $V_0(\eta) = \frac{1}{2}\eta^2$ , we have

$$\frac{\partial V_0}{\partial \eta}(-\eta^3) = -\eta^4, \quad \frac{\partial V_0}{\partial \eta}(-\xi_1) = -\eta \xi_1 \leq k_1 |\xi_1|$$

## 《非线性系统（第三版）》习题解答

on the set  $\{\|\eta\| \leq k_1\}$ . Therefore, all the assumptions of Exercise 13.20 are satisfied, and we can design a semiglobally stabilizing state feedback control following the procedure outlined there. In particular, Let  $K = [1 \ 1]$ ; then,  $A_c - B_c K$  is Hurwitz. A semiglobally stabilizing state feedback control can be taken as

$$u = -\xi_1 \xi_2 + \frac{1}{\varepsilon^2}(-z_1 - z_2) = -\xi_1 \xi_2 - \frac{1}{\varepsilon^2} \xi_1 - \frac{1}{\varepsilon} \xi_2$$

with sufficiently small  $\varepsilon$ .

### • 13.22

$$\dot{\eta} = f_0(\eta, \xi), \quad \dot{\xi} = (A - BK)\xi + B\delta(z)$$

By Theorem 4.16, there is a Lyapunov function  $V_0(\eta)$  that satisfies

$$\frac{\partial V_0}{\partial \eta} f_0(\eta, 0) \leq -\alpha_3(\|\eta\|)$$

in some neighborhood of  $\eta = 0$ , where  $\alpha_3$  is a class  $\mathcal{K}$  function. Let  $P = P^T > 0$  be the solution of the Lyapunov equation  $P(A - BK) + (A - BK)^T P = -I$ . Take

$$V(\eta, \xi) = V_0(\eta) + \lambda \sqrt{\xi^T P \xi}, \quad \lambda > 0$$

as a Lyapunov function candidate for the full system.

$$\dot{V} = \frac{\partial V_0}{\partial \eta} f_0(\eta, 0) + \frac{\partial V_0}{\partial \eta} [f(\eta, \xi) - f_0(\eta, 0)] + \frac{\lambda}{2\sqrt{\xi^T P \xi}} [-\xi^T \xi + 2\xi^T P B \delta] \leq -\alpha_3(\|\eta\|) + k_1 \|\xi\| - \lambda k_2 \|\xi\|_2 + \lambda k_3 \varepsilon$$

where  $k_1$  to  $k_3$  are positive constants. In arriving at the foregoing inequality we have used the fact that  $f_0$  is locally Lipschitz and  $[\partial V_0 / \partial \eta]$  is bounded in some neighborhood of  $\eta = 0$ . Choosing  $\lambda = 2k_1/k_2$  yields

$$\dot{V} \leq -\alpha_3(\|\eta\|) - k_1 \|\xi\|_2 + (2k_1 k_3 / k_2) \varepsilon$$

The conclusion follows from Theorem 8.18.

### • 13.23

$$\dot{\eta} = f_0(\eta, \xi), \quad \dot{\xi} = (A - BK)\xi + B\delta(z)$$

Without loss of generality, assume that  $\|\delta\| \leq k\|z\|$  is satisfied in the 2-norm. By Theorem 4.14, there is a Lyapunov function  $V_0(\eta)$  that satisfies

$$c_1 \|\eta\|_2^2 \leq V_0(\eta) \leq c_2 \|\eta\|_2^2, \quad \frac{\partial V_0}{\partial \eta} f_0(\eta, 0) \leq -c_3 \|\eta\|_2^2, \quad \left\| \frac{\partial V_0}{\partial \eta} \right\| \leq c_4 \|\eta\|_2, \quad \forall \eta$$

Let  $P = P^T > 0$  be the solution of the Lyapunov equation  $P(A - BK) + (A - BK)^T P = -I$ . Take

$$V(\eta, \xi) = V_0(\eta) + \lambda \xi^T P \xi, \quad \lambda > 0$$

as a Lyapunov function candidate for the full system.

$$\begin{aligned} \dot{V} &= \frac{\partial V_0}{\partial \eta} f_0(\eta, 0) + \frac{\partial V_0}{\partial \eta} [f(\eta, \xi) - f_0(\eta, 0)] - \lambda \xi^T \xi + 2\lambda \xi^T P B \delta \\ &\leq -c_3 \|\eta\|_2^2 + c_4 L \|\eta\|_2 \|\xi\|_2 - \lambda \|\xi\|_2^2 + 2\lambda k \|PB\|_2 \|\eta\|_2 \|\xi\|_2 + 2\lambda k \|PB\|_2 \|\xi\|_2^2 \end{aligned}$$

where  $L$  is a global Lipschitz constant for  $f_0$  with respect to  $\xi$ . Let  $k^* = \min\{1/(4\|PB\|_2), (c_4 L)/(2\lambda\|PB\|_2)\}$ . Then, for all  $k \leq k^*$ , we have

$$\dot{V} \leq - \begin{bmatrix} \|\eta\|_2 \\ \|\xi\|_2 \end{bmatrix}^T \begin{bmatrix} c_3 & -c_4 L \\ -c_4 L & \lambda/2 \end{bmatrix} \begin{bmatrix} \|\eta\|_2 \\ \|\xi\|_2 \end{bmatrix}$$

Taking  $\lambda = \lambda^* \stackrel{\text{def}}{=} 4(c_4 L)^2 / c_3$  ensures that the  $2 \times 2$  matrix is positive definite. Consequently, the origin is globally exponentially stable for all  $k \leq \min\{1/(4\|PB\|_2), (c_4 L)/(2\lambda^* \|PB\|_2)\}$ .

## 《非线性系统（第三版）》习题解答

• 13.24

$$\dot{\eta} = f_0(\eta, \xi), \quad \dot{\xi} = (A - BK)\xi + B\delta(z)$$

Without loss of generality, assume that  $\|\delta\| \leq k\|\xi\| + W(\eta)$  is satisfied in the 2-norm. The derivative of  $V(\eta, \xi) = V_0(\eta) + \lambda\sqrt{\xi^T P \xi}$  is given by

$$\begin{aligned} \dot{V} &= \frac{\partial V_0}{\partial \eta} f_0(\eta, 0) + \frac{\partial V_0}{\partial \eta} [f(\eta, \xi) - f_0(\eta, 0)] + \frac{\lambda}{2\sqrt{\xi^T P \xi}} [-\xi^T \xi + 2\xi^T P B \delta] \\ &\leq -W(\eta) + k_1 \|\xi\|_2 - \lambda k_2 \|\xi\|_2 + \lambda k_3 \|\delta\|_2 \\ &\leq -W(\eta) + k_1 \|\xi\|_2 - \lambda k_2 \|\xi\|_2 + \lambda k_3 k \|\xi\|_2 + \lambda k_3 k W(\eta) \\ &= -(1 - \lambda k_3 k) W(\eta) - (\lambda k_2 - k_1 - \lambda k_3 k) \|\xi\|_2 \end{aligned}$$

where  $k_1$  to  $k_3$  are positive constants. In arriving at the foregoing inequality we have used the fact that  $f_0$  is locally Lipschitz and  $[\partial V_0 / \partial \eta]$  is bounded in some neighborhood of  $\eta = 0$ . Take  $\lambda = 2k_1/k_2$  and  $k^* = \min\{1, k_1\}/(2\lambda k_3)$ . Then, for all  $k \leq k^*$ , we have

$$\dot{V} \leq -\frac{1}{2}W(\eta) - \frac{1}{2}k_1\|\xi\|_2$$

which shows that the origin is asymptotically stable.

• 13.25

$$y = x_1 \Rightarrow \dot{y} = x_2 + 2x_1^2 \Rightarrow \ddot{y} = x_3 + u + 2x_1(x_2 + x_1^2)$$

Therefore, the system has relative degree 2 in  $R^3$ . Let us check the minimum-phase property.

$$y(t) \equiv 0 \Rightarrow \dot{x}_3 = -x_3$$

Hence, the system is minimum phase. Let  $e = y - r$ .

$$\ddot{e} = \ddot{y} - \ddot{r} = x_3 + u + 2x_1(x_2 + x_1^2) - \ddot{r}$$

Take

$$\begin{aligned} u &= -x_3 - 2x_1(x_2 + x_1^2) + \ddot{r} - k_1 e - k_2 \dot{e} \\ &= -x_3 - 2x_1(x_2 + x_1^2) + \ddot{r} - k_1(x_1 - r) - k_2(x_2 + 2x_1^2 - \dot{r}) \end{aligned}$$

where  $k_1$  and  $k_2$  are positive constants. The tracking error  $e$  satisfies the equation  $\ddot{e} + k_2\dot{e} + k_1e = 0$ , which shows that  $e(t) \rightarrow 0$  as  $t \rightarrow \infty$ .

• 13.26

$$y = x_1 \Rightarrow \dot{y} = x_2 + x_1 \sin x_1 \Rightarrow \ddot{y} = x_1 x_2 + u + (\sin x_1 + x_1 \cos x_1)(x_2 + x_1 \sin x_1)$$

Therefore, the system has relative degree 2 in  $R^2$ . Let  $e = y - r$ .

$$\ddot{e} = \ddot{y} - \ddot{r} = x_1 x_2 + u + (\sin x_1 + x_1 \cos x_1)(x_2 + x_1 \sin x_1) - \ddot{r}$$

Take

$$u = -x_1 x_2 - (\sin x_1 + x_1 \cos x_1)(x_2 + x_1 \sin x_1) + \ddot{r} - k_1 e - k_2 \dot{e}$$

where  $k_1$  and  $k_2$  are positive constants. The tracking error  $e$  satisfies the equation  $\ddot{e} + k_2\dot{e} + k_1e = 0$ , which shows that  $e(t) \rightarrow 0$  as  $t \rightarrow \infty$ .

## 《非线性系统（第三版）》习题解答

- 13.27 (a) Denote the gravitational constant by  $g_0$  and write the state equation as  $\dot{x} = f(x) + g(x)u$ .

$$\begin{aligned} ad_f g &= [f, g] = \frac{\partial g}{\partial x} f - \frac{\partial f}{\partial x} g = \begin{bmatrix} 0 & 0 & 0 \\ 0 & 0 & 0 \\ (\partial g_3 / \partial x_1) & 0 & 0 \end{bmatrix} \begin{bmatrix} f_1 \\ f_2 \\ f_3 \end{bmatrix} - \begin{bmatrix} 0 & 1 & 0 \\ * & * & (\partial f_2 / \partial x_3) \\ * & * & (\partial f_3 / \partial x_3) \end{bmatrix} \begin{bmatrix} 0 \\ 0 \\ g_3 \end{bmatrix} \\ &= \begin{bmatrix} 0 \\ -(\partial f_2 / \partial x_3) g_3 \\ (\partial g_3 / \partial x_1) f_1 - (\partial f_3 / \partial x_3) g_3 \end{bmatrix} \end{aligned}$$

$$\begin{aligned} [g, ad_f g] &= \frac{\partial (ad_f g)}{\partial x} g - \frac{\partial g}{\partial x} (ad_f g) = \begin{bmatrix} 0 & 0 & 0 \\ * & 0 & -(\partial f_2^2 / \partial x_3^2) g_3 \\ * & * & 0 \end{bmatrix} \begin{bmatrix} 0 \\ 0 \\ g_3 \end{bmatrix} - \begin{bmatrix} 0 & 0 & 0 \\ 0 & 0 & 0 \\ * & 0 & 0 \end{bmatrix} \begin{bmatrix} 0 \\ * \\ * \end{bmatrix} \\ &= \begin{bmatrix} 0 \\ -(\partial f_2^2 / \partial x_3^2) g_3^2 \\ 0 \end{bmatrix} = \frac{(\partial f_2^2 / \partial x_3^2)}{(\partial f_3 / \partial x_3)} \left[ ad_f g - \frac{1}{g_3} ((\partial g_3 / \partial x_1) f_1 - (\partial f_3 / \partial x_3) g_3) g \right] \end{aligned}$$

The foregoing representation of  $ad_f g$  is valid in the domain  $D = \{a + x_1 > 0 \text{ and } x_3 > 0\}$  since in this domain

$$\frac{\partial f_2}{\partial x_3} = -\frac{L_0 a x_3}{m(a + x_1)^2}$$

is well defined and different than zero. Hence, the distribution  $\{g, ad_f g\}$  is involutive.

$$\begin{aligned} ad_f^2 g &= [f, ad_f g] = \frac{\partial (ad_f g)}{\partial x} f - \frac{\partial f}{\partial x} (ad_f g) \\ &= \begin{bmatrix} 0 & 0 & 0 \\ * & 0 & * \\ * & * & 0 \end{bmatrix} \begin{bmatrix} f_1 \\ f_2 \\ f_3 \end{bmatrix} - \begin{bmatrix} 0 & 1 & 0 \\ * & * & * \\ * & * & * \end{bmatrix} \begin{bmatrix} 0 \\ -(\partial f_2 / \partial x_3) g_3 \\ * \end{bmatrix} = \begin{bmatrix} -(\partial f_2 / \partial x_3) g_3 \\ * \\ * \end{bmatrix} \end{aligned}$$

$$\mathcal{G} = [g \quad ad_f g \quad ad_f^2 g] = \begin{bmatrix} 0 & 0 & -(\partial f_2 / \partial x_3) g_3 \\ 0 & -(\partial f_2 / \partial x_3) g_3 & * \\ g_3 & * & * \end{bmatrix}$$

$$\det(\mathcal{G}) = -g_3 \left( \frac{\partial f_2}{\partial x_3} g_3 \right)^2 = -\frac{L_0^2 a^2 x_3^2}{L^3(x_1) m^2 (a + x_1)^4} \neq 0 \text{ for } x \in D$$

Thus, the system is feedback linearizable in  $D$ .

(b) Find  $h(x)$  such that

$$h(0) = 0, \quad \frac{\partial h}{\partial x} g = 0, \quad \frac{\partial (L_f h)}{\partial x} g = 0, \quad \frac{\partial (L_f^2 h)}{\partial x} g \neq 0$$

Try  $h = h(x_1)$ .

$$h = h(x_1) \Rightarrow \frac{\partial h}{\partial x_3} = 0 \Rightarrow \frac{\partial h}{\partial x} g = 0$$

$$L_f h = \frac{\partial h}{\partial x} f = \frac{\partial h}{\partial x_1} x_2 \Rightarrow \frac{\partial (L_f h)}{\partial x} g = 0$$

$$L_f^2 h = \frac{\partial (L_f h)}{\partial x} f = \frac{\partial^2 h}{\partial x_1^2} x_2^2 + \frac{\partial h}{\partial x_1} \left( g_0 - \frac{k}{m} x_2 - \frac{a L_0 x_3^2}{2m(a + x_1)^2} \right)$$

$$\frac{\partial (L_f^2 h)}{\partial x_3} = -\frac{\partial h}{\partial x_1} \frac{a L_0 x_3}{m(a + x_1)^2}$$

## 《非线性系统（第三版）》习题解答

Then,  $[\partial(L_f^2 h)/\partial x]g \neq 0$  for all  $x \in D$ . Take  $h = x_1$ , to obtain

$$T(x) = \begin{bmatrix} x_1 \\ x_2 \\ g_0 - \frac{k}{m}x_2 - \frac{aL_0x_3^2}{2m(a+x_1)^2} \end{bmatrix}$$

It can be verified that  $T(x)$  is a diffeomorphism in  $D$ . The change of variables  $z = T(x)$  transforms the system into

$$\begin{aligned} \dot{z}_1 &= z_2 \\ \dot{z}_2 &= z_3 \\ \dot{z}_3 &= -\frac{k}{m}z_3 - \frac{aL_0x_3}{mL(x_1)(a+x_1)^2} \left[ -Rx_3 + \frac{L_0ax_2x_3}{(a+x_1)^2} + u \right] + \frac{aL_0x_3^2x_2}{m(a+x_1)^3} \\ &= -\frac{k}{m}z_3 - \frac{aL_0x_3}{mL(x_1)(a+x_1)^2} \left[ -Rx_3 - \frac{L_1x_2x_3}{a+x_1} + u \right] \end{aligned}$$

Take

$$u = Rx_3 + \frac{L_1x_2x_3}{a+x_1} - \frac{mL(x_1)(a+x_1)^2}{aL_0x_3} v$$

to obtain

$$\dot{z}_1 = z_2, \quad \dot{z}_2 = z_3, \quad \dot{z}_3 = -\frac{k}{m}z_3 + v$$

To stabilize the ball at  $y = r$ , take

$$v = -k_1(z_1 - r) - k_2z_2 - k_3z_3$$

The overall control is

$$u = Rx_3 + \frac{L_1x_2x_3}{a+x_1} + \frac{mL(x_1)(a+x_1)^2}{aL_0x_3} [k_1(z_1 - r) + k_2z_2 + k_3z_3]$$

The feedback gains are chosen as  $k_1 = 2000$ ,  $k_2 = 400$ , and  $k_3 = 30$  to assign the eigenvalues of

$$\begin{bmatrix} 0 & 1 & 0 \\ 0 & 0 & 1 \\ -k_1 & -k_2 & -(k_3 + k/m) \end{bmatrix} \approx \begin{bmatrix} 0 & 1 & 0 \\ 0 & 0 & 1 \\ -k_1 & -k_2 & -k_3 \end{bmatrix}$$

at  $-10$ ,  $-10 \pm j10$ . The step response of  $y$  and  $u$  for  $y(0) = 0$  and  $y(0) = 0.089$  (with other initial states equal to zero) are shown in Figure 13.2. To account for the constraint  $0 \leq u \leq 15$ , a limiter is included in the Simulink simulation model. The response is considered feasible only if  $y$  belongs to the interval  $[0, 0.1]$ . Using this criterion, 0.089 is the largest acceptable initial position. Comparing these results with those of Exercise 12.8, we see that the response has less overshoot in the current design. Consequently, the maximum deviation of  $y(0)$  is 0.089 compared with 0.07 in Exercise 12.8. Figure 13.3 shows the response for different values of  $m$ . These values are the extreme values for which a feasible response is obtained for the given initial position. There is a large steady-state error. The smallest mass we could work with was  $m = 0.067$ , compared with  $m = 0.046$  in Exercise 12.8. This could be an indication that feedback linearization is more sensitive to parameter perturbations. The large steady-state error can be handled by the use of integral control.

(c) From part (b), we know that the system is feedback linearizable with  $h(x) = x_1$ . This shows that, with  $y = x_1$  as the output, the system is input-output linearizable. Proceed to design the tracking control following the steps of Section 13.4.2.

## 《非线性系统（第三版）》习题解答

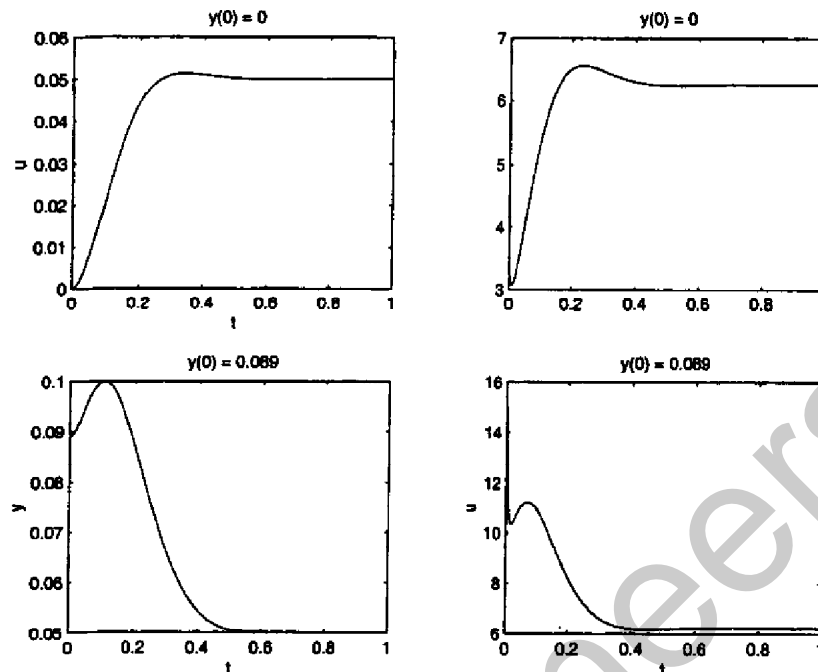

Figure 13.2: Exercise 13.27.

• 13.28 (a)

$$y = x_2 \Rightarrow \dot{y} = -\theta_4 x_2 + \theta_5 x_1 u$$

Let  $D = \{x \in R^2 \mid x_1 > \theta_3/2\theta_1\}$ . The system has relative degree 1 in  $D$ . Therefore, it is input-output linearizable.

(b)

$$y(t) \equiv 0 \Rightarrow x_2(t) \equiv 0 \Rightarrow \dot{x}_1 = -\theta_1 x_1 + \theta_3$$

The zero dynamics equation has a globally exponentially stable equilibrium point at  $x_1 = \theta_3/\theta_1$ . Therefore, the system is minimum phase.

(c) Let  $e = y - r$ .

$$\dot{e} = -\theta_4 x_2 + \theta_5 x_1 u - \dot{r}$$

The control

$$u = \frac{1}{\theta_5 x_1} [\theta_4 x_2 + \dot{r} - ke], \quad k > 0$$

results in  $\dot{e} = -ke$ . Hence,  $e(t) \rightarrow 0$  as  $t \rightarrow \infty$ .

(d)

(1) Figure 13.4 shows the response for  $\tau = 0.1$  and  $k = 1$ . The settling time is about 0.5.

(2) To decrease the settling time,  $\tau$  was reduced to  $\tau = 0.02$ . The response didn't improve because reducing  $\tau$  increases  $\dot{r}$  while the control is limited to  $\pm 0.05$ . This situation can be improved by increasing the feedback gain  $k$ . Figure 13.5 shows the response for  $\tau = 0.02$  and  $k = 10$ . The settling time is about 0.1. Notice, however, that the control saturates as a result of the increase in  $\dot{r}$ .

(3) The response with a 50% decrease and 50% increase in  $J$  is shown in Figure 13.6. The settling time deteriorates.

(4) Increasing  $k$  to  $k = 10$  improves the response a lot, as shown in Figure 13.6.

## 《非线性系统（第三版）》习题解答

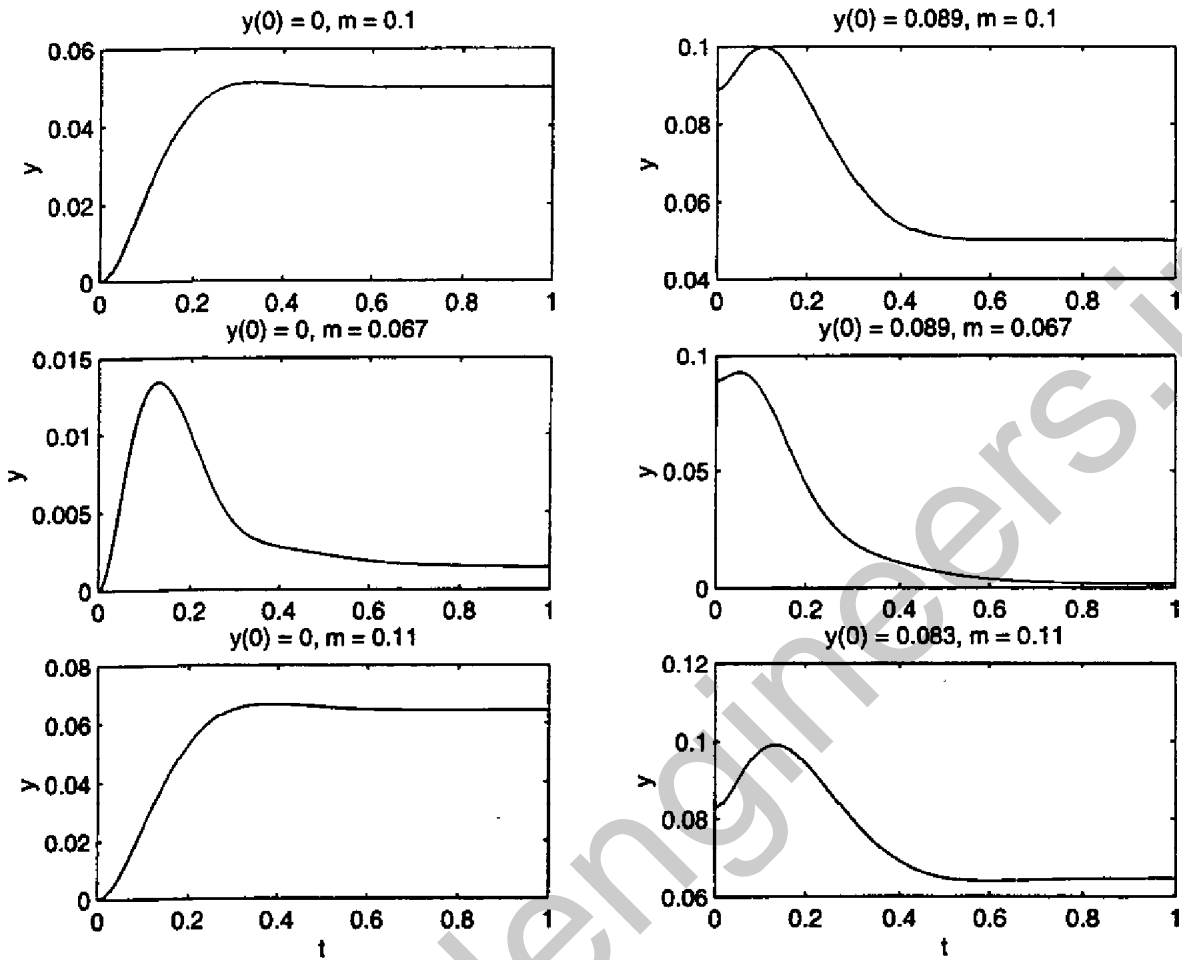

Figure 13.3: Exercise 13.27.

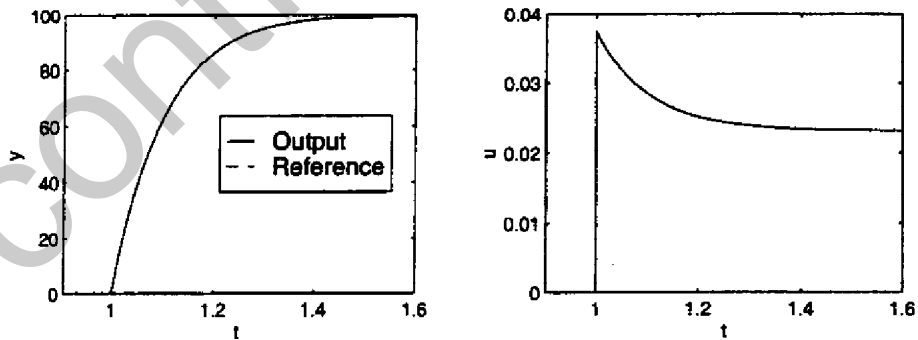

Figure 13.4: Exercise 13.28.

《非线性系统（第三版）》习题解答

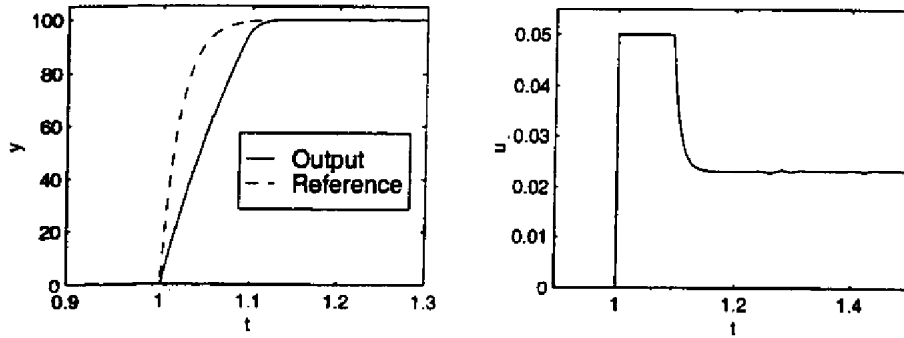

Figure 13.5: Exercise 13.28.

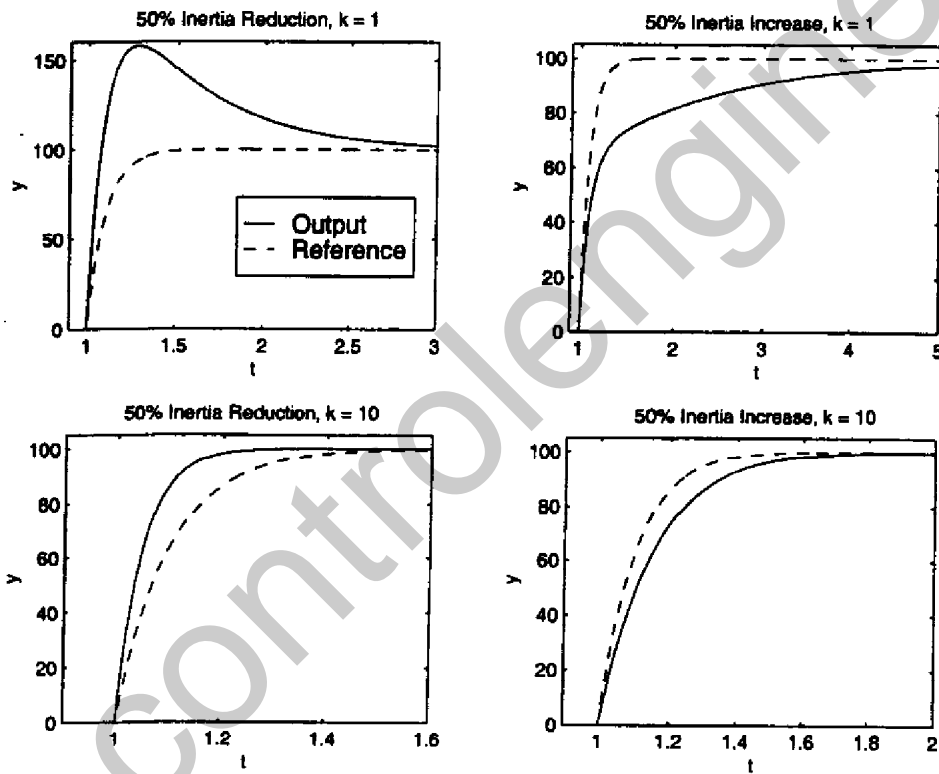

Figure 13.6: Exercise 13.28.



## 《非线性系统（第三版）》习题解答

### Chapter 14

- 14.1 (a) Let  $s = a_1 x_1 + x_2$ , where  $a_1 > 0$ . On the sliding surface  $s = 0$ , we have  $\dot{x}_1 = -a_1 x_1 + \sin x_1$ . Choosing  $a_1 > 1$  ensures that the origin  $x_1 = 0$  is asymptotically stable.

$$\dot{s} = a_1 \dot{x}_1 + \dot{x}_2 = a_1(x_2 + \sin x_1) + \theta_1 x_1^2 + (1 + \theta_2)u$$

Taking  $u = -a_1(x_2 + \sin x_1) + v$  yields

$$\dot{s} = \theta_1 x_1^2 - \theta_2 a_1(x_2 + \sin x_1) + (1 + \theta_2)v$$

$$s\dot{s} = \theta_1 s x_1^2 - \theta_2 a_1 s(x_2 + \sin x_1) + (1 + \theta_2)sv \leq 2x_1^2 |s| + (a_1/2)|x_2 + \sin x_1| |s| + (1 + \theta_2)sv$$

Take  $v = -\beta(x)\text{sat}(s/\varepsilon)$ ,  $\varepsilon > 0$ . For  $|s| \geq \varepsilon$ , we have

$$s\dot{s} \leq 2x_1^2 |s| + (a_1/2)|x_2 + \sin x_1| |s| - (1/2)\beta(x)|s|$$

Take  $\beta(x) = 4x_1^2 + a_1|x_2 + \sin x_1| + \beta_0$ ,  $\beta_0 > 0$ . Then  $s\dot{s} \leq -\beta_0 |s|/2$ , which shows that the trajectories reach the boundary layer  $\{|s| \leq \varepsilon\}$  in finite time. Inside the boundary layer we have

$$\dot{x}_1 = -a_1 x_1 + \sin x_1 + s$$

Let  $V_1 = \frac{1}{2}x_1^2$ .

$$\dot{V}_1 = -a_1 x_1^2 + x_1 \sin x_1 + x_1 s \leq -(a_1 - 1)x_1^2 + |x_1|\varepsilon$$

Take  $a_1 = 2$ .

$$\dot{V}_1 \leq -x_1^2 + |x_1|\varepsilon \leq -(1/2)x_1^2, \quad \forall |x_1| \geq 2\varepsilon$$

Thus, the trajectories reach the set  $\Omega_\varepsilon = \{|x_1| \leq 2\varepsilon, |s| \leq \varepsilon\}$  in finite time. Inside  $\Omega_\varepsilon$ , the system is represented by

$$\dot{x}_1 = -2x_1 + \sin x_1 + s, \quad \dot{s} = \theta_1 x_1^2 - 2\theta_2(s - 2x_1 + \sin x_1) - (1 + \theta_2)(s/\varepsilon)$$

Let  $V_2 = \frac{1}{2}(x_1^2 + s^2)$ .

$$\begin{aligned} \dot{V}_2 &= -2x_1^2 + x_1 \sin x_1 + x_1 s + \theta_1 x_1^2 s - 2\theta_2(s - 2x_1 + \sin x_1)s - (1 + \theta_2)s^2/\varepsilon \\ &\leq -x_1^2 + 4(1 + \varepsilon)|x_1||s| - \left(\frac{1}{2\varepsilon} - 1\right)s^2 \\ &= -\begin{bmatrix} |x_1| \\ |s| \end{bmatrix}^T \begin{bmatrix} 1 & -2(1 + \varepsilon) \\ -2(1 + \varepsilon) & (1/2\varepsilon) - 1 \end{bmatrix} \begin{bmatrix} |x_1| \\ |s| \end{bmatrix} \end{aligned}$$

The  $2 \times 2$  matrix is positive definite for sufficiently small  $\varepsilon$ . Hence, all trajectories in  $\Omega_\varepsilon$  approach the origin at  $t$  tends to infinity.

(b) Let  $e_1 = x_1 - r$  and  $e_2 = \dot{e}_1 = \dot{x}_1 - \dot{r} = x_2 + \sin x_1 - \dot{r}$ .

$$\dot{e}_1 = e_2, \quad \dot{e}_2 = \theta_1 x_1^2 + (1 + \theta_2)u + (x_2 + \sin x_1) \cos x_1 - \ddot{r}$$

## 《非线性系统（第三版）》习题解答

Let the sliding manifold be  $e_2 = -a_1 e_1$ ,  $a_1 > 0$ , and set  $s = e_2 + a_1 e_1$ .

$$\dot{s} = \theta_1 x_1^2 + (1 + \theta_2)u + (x_2 + \sin x_1) \cos x_1 - \ddot{r} + a_1 e_2$$

Take

$$u = -(x_2 + \sin x_1) \cos x_1 + \ddot{r} - a_1 e_2 + v$$

$$\dot{s} = v + \delta, \quad \text{where } \delta = \theta_1 x_1^2 + \theta_2 [-(x_2 + \sin x_1) \cos x_1 + \ddot{r} - a_1 e_2] + \theta_2 v$$

$$|\delta| \leq 2x_1^2 + \frac{1}{2} |(x_2 + \sin x_1) \cos x_1 + a_1 e_2| + \frac{1}{2} |\ddot{r}| + \frac{1}{2} |v|$$

Take

$$\beta(x) \geq 2 \left[ 2x_1^2 + \frac{1}{2} |(x_2 + \sin x_1) \cos x_1 + a_1 e_2| + \frac{1}{2} |\ddot{r}| \right] + \beta_0, \quad \beta_0 > 0$$

and

$$v = -\beta(x) \operatorname{sat} \left( \frac{s}{\varepsilon} \right)$$

For  $|s| \geq \varepsilon$ ,

$$s\dot{s} \leq -\beta_0 |s|$$

which implies that the trajectories reach the boundary layer  $\{|s| \leq \varepsilon\}$  in finite time. Inside the boundary layer,

$$\dot{e}_1 = -a_1 e_1 + s \quad \Rightarrow \quad e_1 \dot{e}_1 \leq -a_1 e_1^2 + \varepsilon |e_1|$$

Take  $a_1 = 2$ .

$$e_1 \dot{e}_1 \leq -e_1^2, \quad \forall |e_1| \geq \varepsilon$$

Thus,  $|e_1(t)| \leq \varepsilon$  after a finite time.

• 14.2 (a)

$$\dot{x}_1 = x_2, \quad \dot{x}_2 = -ax_2|x_2| + u, \quad y = x_1$$

(b)

$$\dot{y} = x_2, \quad \ddot{y} = -ax_2|x_2| + u$$

The system has relative degree 2 in  $\mathbb{R}^2$ . Hence, it is input-output linearizable. In fact, the system is globally input-output linearizable since the control  $u = ax_2|x_2| + v$  results in a chain of two integrators from  $v$  to  $y$ .

(c) Let  $e_1 = x_1 - \psi_r$  and  $e_2 = x_2 - \dot{\psi}_r$ .

$$\dot{e}_1 = e_2, \quad \dot{e}_2 = -ax_2|x_2| + u - \ddot{\psi}_r$$

Taking

$$u = \hat{a}x_2|x_2| + \ddot{\psi}_r - e_1 - e_2$$

results in the linear error equation

$$\dot{e}_1 = e_2, \quad \dot{e}_2 = -e_1 - e_2$$

whose matrix  $A = \begin{bmatrix} 0 & 1 \\ -1 & -1 \end{bmatrix}$  is Hurwitz. Hence, the control achieves global tracking.

(d) When  $\hat{a} \neq a$ , the error equation is

$$\dot{e}_1 = e_2, \quad \dot{e}_2 = -e_1 - e_2 - (a - \hat{a})x_2|x_2|$$

The perturbation term satisfies

$$(a - \hat{a})x_2|x_2| \leq 0.01x_2^2 = 0.01(e_2 + 2 \cos 2t)^2 \leq 0.01(e_2^2 + 4|e_2| + 4)$$

## 《非线性系统（第三版）》习题解答

To show ultimate boundedness, we need to bound the perturbation term by a linear growth bound. Restrict  $e_2$  to  $|e_2| \leq k_2$ . Then,

$$(a - \hat{a})x_2|x_2| \leq 0.01(k_2 + 4)|e_2| + 0.04$$

The solution of the Lyapunov equation  $PA + A^T P = -I$  is  $P = \begin{bmatrix} 1.5 & 0.5 \\ 0.5 & 1 \end{bmatrix}$ . Use  $V = e^T P e$  as a Lyapunov function.

$$\begin{aligned} \dot{V} &= -\|e\|_2^2 - (e_1 + 2e_2)(a - \hat{a})x_2|x_2| \leq -\|e\|_2^2 + \sqrt{5}\|e\|_2[0.01(k_2 + 4)\|e\|_2 + 0.04] \\ &= -[1 - 0.01\sqrt{5}(4 + k_2)]\|e\|_2^2 + 0.04\sqrt{5}\|e\|_2 \end{aligned}$$

Take  $k_2 = 4$ .

$$\begin{aligned} \dot{V} &= -0.821\|e\|_2^2 + 0.089\|e\|_2 = -0.001\|e\|_2^2 - 0.82\|e\|_2^2 + 0.089\|e\|_2 \\ &\leq -0.001\|e\|_2^2, \quad \forall \|e\|_2 \geq \frac{0.089}{0.82} \stackrel{\text{def}}{=} \mu \end{aligned}$$

It follows from Theorem 4.18 that the ultimate bound is given by

$$b = \mu \sqrt{\frac{\lambda_{\max}(P)}{\lambda_{\min}(P)}} = 0.1085 \sqrt{\frac{1.809}{0.691}} = 0.176$$

This ultimate bound is not valid globally because we restricted the analysis to the set  $\{|e_2| \leq 4\}$ .

(e) Use sliding mode control with  $s = e_1 + e_2$ .

$$\dot{s} = e_2 - ax_2|x_2| + u - \ddot{\psi}_r = e_2 - x_2|x_2| - (a - \hat{a})x_2|x_2| + u - \ddot{\psi}_r$$

Take  $u = -e_2 + x_2|x_2| + \ddot{\psi}_r + v$ .

$$s\dot{s} = -(a - \hat{a})x_2|x_2|s + sv \leq 0.01x_2^2|s| + sv$$

Take  $v = -(0.01x_2^2 + 0.1) \text{sat}(s/\varepsilon)$ . After some finite time,  $|s| \leq \varepsilon$ . From the equation  $\dot{e}_1 = -e_1 + s$ , we see that after some finite time  $|e_1| \leq \varepsilon/\theta$ , where  $0 < \theta < 1$ . Choose  $\varepsilon < 0.01$  to ensure that the ultimate bound on  $|e_1|$  is 0.01.

### • 14.3

$$\dot{x}_1 = x_2, \quad \dot{x}_2 = -\omega^2 x_1 + \varepsilon\omega(1 - \mu^2 x_1^2)x_2 u$$

(a) For  $u = 1$ , this is the standard van der Pol oscillator which is known to have a stable limit cycle. The fact that the limit cycle is outside a circle of radius  $1/\mu$  in the plane  $(x_1, x_2/\omega)$  can be shown by transforming the equation into polar coordinates. Let

$$\begin{aligned} \rho^2 &= x_1^2 + x_2^2/\omega^2 \\ \rho\dot{\rho} &= \frac{\varepsilon}{\omega}(1 - \mu^2 x_1^2)x_2^2 \end{aligned}$$

On the circle  $\rho = 1/\mu$ , we have  $|x_1| \leq 1/\mu$ , which implies that  $(1 - \mu^2 x_1^2) \geq 0$ . Hence, all trajectories on this circle must be moving to the outside. Therefore, the stable limit cycle must be outside the circle. For  $u = -1$ , we can show the existence of the unstable limit cycle by reversing time and scaling the state variable to arrive again at the standard van der Pol oscillator.

(b) We have

$$s = x_1^2 + \frac{x_2^2}{\omega^2} - r^2, \quad \dot{s} = \frac{2\varepsilon}{\omega}(1 - \mu^2 x_1^2)x_2^2 u$$

Now

$$s(t) \equiv 0 \Rightarrow \dot{s}(t) \equiv 0 \Rightarrow u(t) \equiv 0$$

## 《非线性系统（第三版）》习题解答

Therefore, the state equation reduces to a harmonic oscillator

$$\dot{x}_1 = x_2, \quad \dot{x}_2 = -\omega^2 x_1$$

(c)

$$s\dot{s} = \frac{2\varepsilon}{\omega}(1 - \mu^2 x_1^2)x_2^2 u s$$

For  $s \neq 0$ , take  $u = -\text{sgn}(s)$ .

$$s\dot{s} = -\frac{2\varepsilon}{\omega}(1 - \mu^2 x_1^2)x_2^2 |s|$$

Inside the band  $|x_1| < 1/\mu$ , the term  $(1 - \mu^2 x_1^2)$  is positive. Therefore,  $s\dot{s} \leq 0$ . In fact,  $s\dot{s} < 0$  except on the line  $x_2 = 0$ . Since no trajectory (other than  $x(t) \equiv 0$ ) can stay identically in the set  $x_2 = 0$ , we conclude that  $s(t)$  must reach zero; that is, the trajectory must reach the sliding manifold.

(d) Simulation results for  $u = -\text{sat}(s/0.01)$  are shown in Figure 14.1.

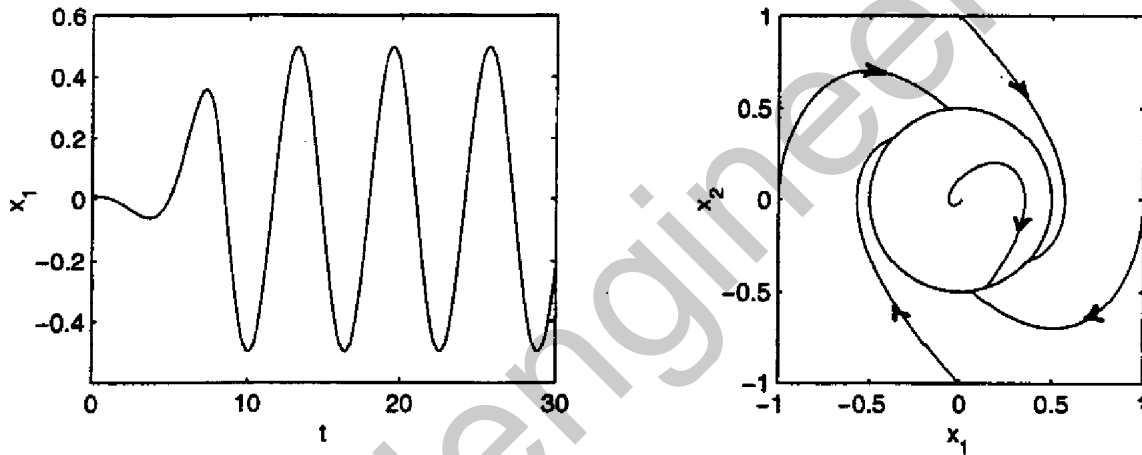

Figure 14.1: Exercise 14.3.

- 14.4 Let  $V_1 = \frac{1}{2}x_1^2$  be a Lyapunov function candidate for  $\dot{x}_1 = x_2 + ax_1 \sin x_1$ .

$$\dot{V}_1 = x_1 x_2 + ax_1^2 \sin x_1 \leq x_1 x_2 + 2x_1^2$$

The origin  $x_1 = 0$  can be globally stabilized with  $x_2 = -3x_1$  since  $\dot{V}_1 \leq -x_1^2$ . Take  $s = 3x_1 + x_2$ .

$$\dot{s} = 3\dot{x}_1 + \dot{x}_2 = 3(x_2 + ax_1 \sin x_1) + bx_1 x_2 + u$$

Take

$$u = -3(x_2 + x_1 \sin x_1) - x_1 x_2 + v$$

$$\dot{s} = -3(a-1)x_1 \sin x_1 + (b-1)x_1 x_2 + v$$

$$|-3(a-1)x_1 \sin x_1 + (b-1)x_1 x_2| \leq |x_1|(3+2|x_2|)$$

Taking

$$v = -[1 + |x_1|(3+2|x_2|)] \text{sat}\left(\frac{s}{\varepsilon}\right)$$

ensures that  $s(t)$  reaches the boundary layer  $\{|s| \leq \varepsilon\}$  in finite time. Since the origin of  $\dot{x}_1 = -3x_1 + ax_1 \sin x_1$  is exponentially stable, it follows from Theorem 14.2 that the origin  $x = 0$  is globally asymptotically stable.

## 《非线性系统（第三版）》习题解答

- 14.5 Let  $x_1 = \theta$ ,  $x_2 = \dot{\theta}$ ,  $u = T$ ,  $a = g/\ell$ ,  $b = k/m$ ,  $c = 1/m\ell^2$ , and  $\zeta(t) = h(t)/\ell$ , to obtain

$$\dot{x}_1 = x_2, \quad \dot{x}_2 = -a \sin x_1 - bx_2 + cu + \zeta(t) \cos x_1$$

Take  $s = x_1 + x_2$ . Then,

$$\dot{s} = x_2 - a \sin x_1 - bx_2 + cu + \zeta(t) \cos x_1 = c[u + \delta]$$

where

$$\delta = \frac{1}{c} [x_2 - a \sin x_1 - bx_2 + \zeta(t) \cos x_1]$$

$$|\delta| \leq \left| \frac{a}{c} \right| |x_1| + \left| \frac{1-b}{c} \right| |x_2| + \left| \frac{\zeta(t)}{c} \right| \leq 16.1865|x_1| + 1.815|x_2| + 1.1111$$

Take

$$u = -[16.1865|x_1| + 1.815|x_2| + 2] \operatorname{sat} \left( \frac{s}{\varepsilon} \right)$$

The trajectory reaches the boundary layer  $\{|s| \leq \varepsilon\}$  in finite time. Inside the boundary layer, we have  $\dot{x}_1 = -x_1 + s$ . Taking  $V_1 = x_1^2/2$ , we obtain

$$\dot{V}_1 = -x_1^2 + x_1 s \leq -x_1^2 + |x_1|\varepsilon \leq -(1-\theta)x_1^2, \quad \forall |x_1| \geq \frac{\varepsilon}{\theta}$$

where  $0 < \theta < 1$ . Thus, the trajectory reaches the set  $\Omega_\varepsilon = \{|x_1| \leq \varepsilon/\theta, |x_1 + x_2| \leq \varepsilon\}$  in finite time. Inside this set,

$$|x_2| = |x_1 + x_2 - x_1| \leq |x_1 + x_2| + |x_1| \leq (1 + 1/\theta)\varepsilon$$

For  $\theta = 0.9$ , we have  $|x_2| \leq 2.11\varepsilon$ . Choose  $\varepsilon$  small enough that  $2.11\varepsilon \leq 0.01$ . In particular, take  $\varepsilon = 0.004$ .

- 14.6 (a) The system  $\dot{x}_1 = x_1 x_2$ , with  $x_2$  viewed as the control input, can be globally stabilized by  $x_2 = -x_1^2$ . Take  $s = x_1^2 + x_2$ .

$$\dot{s} = 2x_1 \dot{x}_1 + \dot{x}_2 = 2x_1^2 x_2 + x_1 + u$$

Take

$$u = -2x_1^2 x_2 - x_1 - \operatorname{sat} \left( \frac{s}{\varepsilon} \right)$$

$$s\dot{s} = -|s|, \quad \text{for } |s| \geq \varepsilon$$

Hence, the trajectories reach the boundary layer  $\{|s| \leq \varepsilon\}$  in finite time. Inside the boundary layer, we have

$$\dot{x}_1 = -x_1^3 + x_1 s$$

Let  $V_1 = \frac{1}{2}x_1^2$ .

$$\dot{V}_1 = -x_1^4 + x_1^2 s \leq -x_1^4 + x_1^2 \varepsilon \leq -(1/2)x_1^4, \quad \forall |x_1| \geq \sqrt{2\varepsilon}$$

Thus the trajectories reach the set  $\Omega_\varepsilon = \{|x_1| \leq \sqrt{2\varepsilon}, |s| \leq \varepsilon\}$  in finite time. Inside  $\Omega_\varepsilon$  the system is represented by

$$\dot{x}_1 = -x_1^3 + x_1 s, \quad \dot{s} = -s/\varepsilon$$

The foregoing analysis shows that the system  $\dot{x}_1 = -x_1^3 + x_1 s$  is input-to-state stable. It follows from Lemma 4.7 that the origin of the cascade system is globally asymptotically stable. Thus, every trajectory inside  $\Omega_\varepsilon$  converges to the origin as  $t$  tends to infinity. Since all trajectories outside  $\Omega_\varepsilon$  reach  $\Omega_\varepsilon$  in finite time, we conclude that the origin is globally asymptotically stable.

(b)

$$f(x) = \begin{bmatrix} x_1 x_2 \\ x_1 \end{bmatrix}, \quad g = \begin{bmatrix} 0 \\ 1 \end{bmatrix}$$

$$ad_f g = \begin{bmatrix} -x_1 \\ 1 \end{bmatrix}, \quad \det \mathcal{G} = \det[g, ad_f g] = x_1$$

Hence,  $\mathcal{G}$  is singular at  $x = 0$ . From Theorem 13.2, we see that the system is not feedback linearizable in the neighborhood of the origin.

## 《非线性系统（第三版）》习题解答

- 14.7 The system is in the regular form with  $\eta = \begin{bmatrix} x_1 \\ x_2 \end{bmatrix}$  and  $\xi = x_3$ . Design  $x_3 = \phi(x_1, x_2)$  such that the origin of

$$\dot{x}_1 = -x_1 + \tanh x_2, \quad \dot{x}_2 = x_2 + \phi$$

is globally asymptotically stable. Take  $\phi = -2x_2$  and  $V = (1/2)(x_1^2 + ax_2^2)$ , where  $a > 0$  is to be chosen.

$$\dot{V} = -x_1^2 + x_1 \tanh x_2 - ax_2^2 \leq -x_1^2 + |x_1| |x_2| - ax_2^2 = - \begin{bmatrix} |x_1| \\ |x_2| \end{bmatrix}^T \begin{bmatrix} 1 & -\frac{1}{2} \\ -\frac{1}{2} & a \end{bmatrix} \begin{bmatrix} |x_1| \\ |x_2| \end{bmatrix}$$

where we have used  $|\tanh x_2| \leq |x_2|$ . Choose  $a > 1/4$  such that  $Q = \begin{bmatrix} 1 & -\frac{1}{2} \\ -\frac{1}{2} & a \end{bmatrix}$  is positive definite. Take  $a = 1$ . Then  $V = (1/2)(x_1^2 + x_2^2)$ . Now, take  $s = x_3 - \phi = x_3 + 2x_2$ .

$$\dot{s} = u + \delta(x) + 2x_2 + 2x_3$$

Take

$$u = -2x_2 - 2x_3 - [\beta(x) + \beta_0] \text{sat} \left( \frac{s}{\varepsilon} \right), \quad \beta_0 > 0$$

$$s\dot{s} = s\delta - (\beta + \beta_0)s \text{sat} \left( \frac{s}{\varepsilon} \right)$$

For  $|s| \geq \varepsilon$ ,

$$s\dot{s} \leq \beta|s| - \beta|s| - \beta_0|s| = -\beta_0|s|$$

Hence,  $s$  reaches the boundary layer  $\{|s| \leq \varepsilon\}$  in finite time. Inside the boundary layer,

$$\dot{x}_1 = -x_1 + \tanh x_2, \quad \dot{x}_2 = -x_2 + s$$

$$\dot{V} \leq -\lambda_{\min}(Q)\|\eta\|_2^2 + |x_2| |s| \leq -\frac{1}{2}\|\eta\|_2^2 + \|\eta\|_2 |s| \leq -\frac{1}{2}(1 - \theta)\|\eta\|_2^2, \quad \forall \|\eta\|_2 \geq \frac{2}{\theta}\|s\|$$

where  $0 < \theta < 1$ . Inequalities (14.14) and (14.15) of the text are satisfied with  $\|\cdot\| = \|\cdot\|_2$ ,  $\alpha_1(r) = \alpha_2(r) = (1/2)r^2$ ,  $\gamma(r) = (2/\theta)r$ . The constant  $k_1 = 1$  since  $s$  is scalar. Thus  $\alpha(r) = \alpha_2(\gamma(r)) = (1/2)(2/\theta)^2 r^2 = (2/\theta^2)r^2$ . The sets  $\Omega$  and  $\Omega_\varepsilon$  are given by

$$\Omega = \left\{ \frac{1}{2}(x_1^2 + x_2^2) \leq c_0 \right\} \times \{|s| \leq c\}, \quad c_0 \geq \frac{2}{\theta^2} c^2$$

$$\Omega_\varepsilon = \left\{ \frac{1}{2}(x_1^2 + x_2^2) \leq \frac{2}{\theta^2} \varepsilon^2 \right\} \times \{|s| \leq \varepsilon\}$$

Choose  $c$  and  $c_0$  such that  $\{\|x\|_\infty \leq k\} \subset \Omega$ .

$$\|x\|_\infty \leq k \Rightarrow |x_i| \leq k, \text{ for } i = 1, 2, 3 \Rightarrow \frac{1}{2}(x_1^2 + x_2^2) \leq k^2 \text{ and } |s| \leq 3k$$

Take  $c = 3k$ ,  $\theta^2 = 0.9$  and  $c_0 = 20k^2$ . We need to estimate the ultimate bound on  $x_1$ .

$$x_1^2 + x_2^2 \leq \frac{4}{0.9} \varepsilon^2 \Rightarrow |x_1| \leq \frac{2\varepsilon}{\sqrt{0.9}} = 2.1082\varepsilon$$

Choose  $\varepsilon$  small enough that  $2.1082\varepsilon \leq 0.01$  or  $\varepsilon \leq 0.0047$ .

- 14.8

$$\dot{\sigma} = e, \quad \dot{e} = \frac{1}{A(y)}(u - c\sqrt{y}) = \frac{1}{\hat{A}(y)}(u - \hat{c}\sqrt{y}) + \delta$$

## 《非线性系统（第三版）》习题解答

where

$$\delta = \left( \frac{1}{A(y)} - \frac{1}{\hat{A}(y)} \right) u - \left( \frac{c}{A(y)} - \frac{\hat{c}}{\hat{A}(y)} \right) \sqrt{y}$$

Let the sliding manifold be  $e = -k_1\sigma$ ,  $k_1 > 0$ , and set  $s = e + k_1\sigma$ .

$$\dot{s} = \frac{1}{\hat{A}(y)} (u - \hat{c}\sqrt{y}) + \delta + k_1 e$$

Take  $u = \hat{c}\sqrt{y} - \hat{A}(y)k_1 e + \hat{A}(y)v$ . Then

$$\dot{s} = v + \delta$$

It can be verified that

$$|\delta| = \left| \frac{\hat{c} - c}{A(y)} \sqrt{y} - \frac{\hat{A}(y) - A(y)}{A(y)} k_1 e + \frac{\hat{A}(y) - A(y)}{A(y)} v \right| \leq \frac{\rho_3}{\rho_1} \sqrt{y} + \rho_4 k_1 |e| + \rho_4 |v|$$

Take

$$\beta(x) = \frac{1}{1 - \rho_4} \left[ \frac{\rho_3}{\rho_1} \sqrt{y} + \rho_4 k_1 |e| \right] + \beta_0, \quad \beta_0 > 0$$

and

$$v = -\beta(x) \text{ sat} \left( \frac{s}{\varepsilon} \right)$$

• **14.9** Part (a) follows from elementary matrix operations, and part (b) is a straightforward application of Frobenius theorem.

• **14.10** It can be verified that  $\dot{s} = Gv + \Delta$ . Therefore, the control can be taken as in (14.11) with  $\rho(x)$  replaced by  $\rho(t, x)$ . The analysis proceeds exactly as in the autonomous case.

• **14.11 (b)**

$$s_i \dot{s}_i = s_i \Delta_i - s_i g_i \beta \sigma(s_i/\varepsilon) \leq g_i \left[ \frac{\Delta_i}{g_i} s_i - \beta s_i \sigma(s_i/\varepsilon) \right]$$

For  $|s_i| \geq \varepsilon$ ,  $s_i \sigma(s_i/\varepsilon) \geq |s_i| \sigma(1)$ . Hence,

$$\begin{aligned} s_i \dot{s}_i &\leq g_i [(\rho + \kappa_0 \beta) |s_i| - \beta |s_i| \sigma(1)] = g_i [\rho |s_i| - (\sigma(1) - \kappa_0) \beta |s_i|] \\ &\leq g_i [\rho |s_i| - \rho |s_i| - (\sigma(1) - \kappa_0) \beta_0 |s_i|] \leq -g_0 \beta_0 [\sigma(1) - \kappa_0] |s_i| \end{aligned}$$

(c) The foregoing inequality shows that the trajectories reach the boundary layer  $\{|s_i| \leq \varepsilon\}$  in finite time and stay therein for all future time. From this point on we can repeat the proof of Theorem 14.1. To prove a result similar to Theorem 14.2, assume  $\rho(0) = 0$  and  $\kappa_0 = 0$ . For  $|s_i| \leq \varepsilon$ ,

$$s_i \sigma(s_i/\varepsilon) = \varepsilon (s_i/\varepsilon) \sigma(s_i/\varepsilon) \geq \varepsilon \sigma(1) (s_i/\varepsilon)^2 = \sigma(1) s_i^2 / \varepsilon$$

Therefore,

$$s_i \dot{s}_i \leq g_i [\rho(x) - \sigma(1) (\beta_0 / \varepsilon) s_i^2] \leq k_1 \|s\|_2^2 + k_2 \|s\|_2 \|\eta\|_2 - (k_3 / \varepsilon) s_i^2$$

Using the Lyapunov function  $W = V_0(\eta) + \frac{1}{2} \sum_{i=1}^p s_i^2$  as in the proof of Theorem 14.2, it can be shown that the origin is asymptotically stable for sufficiently small  $\varepsilon$ .

## 《非线性系统（第三版）》习题解答

• 14.12 (a)

$$\begin{aligned}
 s_i \dot{s}_i &= s_i \Delta_i - g_i s_i \beta_i \operatorname{sgn}(s_i) = g_i \left[ \frac{\Delta_i}{g_i} s_i - \beta_i |s_i| \right] \\
 &\leq g_i \left[ |s_i| \varrho_i + |s_i| \sum_{j=1}^p \kappa_{ij} |v_j| - \beta_i |s_i| \right] \leq g_i \left[ |s_i| \varrho_i + |s_i| \sum_{j=1}^p \kappa_{ij} \beta_j - \beta_i |s_i| \right] \\
 &= g_i \left[ |s_i| \varrho_i + |s_i| \sum_{j=1}^p \kappa_{ij} (\sigma_j + w_j) - (\sigma_i + w_i) |s_i| \right]
 \end{aligned}$$

$$(I - \mathcal{K})\sigma = \bar{\varrho} \Rightarrow \sigma_i - \sum_{j=1}^p \kappa_{ij} \sigma_j = \bar{\varrho}_i$$

$$(I - \mathcal{K})w = b \Rightarrow w_i - \sum_{j=1}^p \kappa_{ij} w_j = b_i$$

$$s_i \dot{s}_i = g_i [ |s_i| \varrho_i - \bar{\varrho}_i |s_i| - b_i |s_i| ] \leq -g_i b_i |s_i| \leq -g_0 b_i |s_i|$$

(b) The condition  $\sum_{j=1}^p \kappa_{ij} \leq \kappa_0 < 1$  implies that  $I - \mathcal{K}$  is diagonally dominant; hence, it is an  $M$ -matrix. Take

$$w = \beta_0 \begin{bmatrix} 1 \\ 1 \\ \vdots \\ 1 \end{bmatrix}, \quad b = (I - \mathcal{K})w, \quad \sigma = \beta \begin{bmatrix} 1 \\ 1 \\ \vdots \\ 1 \end{bmatrix}, \quad \text{and} \quad \bar{\varrho} = (I - \mathcal{K})\sigma$$

$$\bar{\varrho}_i = \sigma_i - \sum_{j=1}^p \kappa_{ij} \sigma_j = (1 - \sum_{j=1}^p \kappa_{ij}) \beta \geq (1 - \kappa_0) \beta$$

Taking  $\beta \geq \varrho / (1 - \kappa_0)$  implies that  $\bar{\varrho}_i \geq \varrho$ .

• 14.13 First we show that  $s$  reaches the boundary layer  $|s| \leq \varepsilon$  in finite time. Then, we use the equation

$$\begin{aligned}
 \dot{e}_1 &= e_2 \\
 &\vdots \\
 \dot{e}_{r-2} &= e_{r-1} \\
 \dot{e}_{r-1} &= -k_1 e_1 \cdots - k_{r-1} e_{r-1} + z
 \end{aligned}$$

to show that  $(e_1, \dots, e_{r-1})$  is ultimately bounded with an  $O(\varepsilon)$  ultimate bound. Therefore,  $e_1$  has an  $O(\varepsilon)$  ultimate bound.

• 14.14 Let  $\hat{a}$ ,  $\hat{b}$ , and  $\hat{c}$  be nominal values of  $a$ ,  $b$ , and  $c$ , respectively. The state equation can be written as

$$\dot{x}_1 = x_2, \quad \dot{x}_2 = -\hat{a} \sin x_1 - \hat{b} x_2 + \hat{c}[u + \delta]$$

where

$$\delta = \left( \frac{\hat{a} - a}{\hat{c}} \right) \sin x_1 + \left( \frac{\hat{b} - b}{\hat{c}} \right) x_2 + \left( \frac{c - \hat{c}}{\hat{c}} \right) u + \left( \frac{\zeta(t)}{\hat{c}} \right) \cos x_1$$



## 《非线性系统（第三版）》习题解答

We have  $0.551 \leq c \leq 2.4691$  and we need to choose  $\hat{c}$  such that  $|(c - \hat{c})/\hat{c}| < 1$ . We take  $\hat{m} = 0.66$  and  $\hat{\ell} = 1$  so that  $\hat{c} = 1.152$  results in  $|(c - \hat{c})/\hat{c}| \leq 0.64$ . We take  $\hat{k} = 0.1$ . These choices of  $\hat{m}$ ,  $\hat{\ell}$  and  $\hat{k}$  result in  $\hat{a} = 9.81$  and  $\hat{b} = 0.152$ . For the nominal design, we take

$$u = \frac{1}{\hat{c}}(\hat{a} \sin x_1 - k_1 x_1 - k_2 x_2)$$

which results in the nominal closed-loop system  $\dot{x} = A_0 x$ , where  $A_0 = \begin{bmatrix} 0 & 1 \\ -k_1 & -(k_2 + \hat{b}) \end{bmatrix}$ . We take  $k_1 = 1$  and  $k_2 = 2 - \hat{b} = 2 - 0.152 = 1.848$  to assign the eigenvalues of  $A_0$  at  $-1$  and  $-1$ . It can be verified that  $P = \begin{bmatrix} 1.5 & 0.5 \\ 0.5 & 0.5 \end{bmatrix}$  is the solution of the Lyapunov equation  $PA_0 + A_0^T P = -I$ . Thus,  $V(x) = x^T P x$  is a Lyapunov function for the nominal closed-loop system. Consequently,  $w = [\partial V / \partial x] G(x) = \hat{c}(x_1 + x_2)$ . Substitution of

$$u = \frac{1}{\hat{c}}[\hat{a} \sin x_1 - x_1 - (2 - \hat{b})x_2] + v$$

in  $\delta$  results in

$$\delta = \frac{1}{\hat{c}} \left[ \left( \frac{\hat{a}c - a\hat{c}}{\hat{c}} \right) \sin x_1 - \left( \frac{c - \hat{c}}{\hat{c}} \right) (x_1 + 2x_2) + \left( \frac{\hat{b}c - b\hat{c}}{\hat{c}} \right) x_2 + \zeta(t) \cos x_1 \right]$$

Hence,

$$|\delta| \leq \rho_1 \|x\|_2 + \rho_2 + k \|v\|_2$$

where  $k = 0.64$ ,  $\rho_2 = 0.66$ , and  $\rho_1$  is an upper bound on

$$\frac{1}{\hat{c}} \left( \left| \frac{\hat{a}c - a\hat{c}}{\hat{c}} \right| + \left| \frac{\hat{b}c - b\hat{c}}{\hat{c}} \right| + k\sqrt{5} \right)$$

let  $\eta = \rho_1 \|x\|_2 + \rho_2$  and take

$$v = \begin{cases} -\frac{\eta}{1-k} \operatorname{sgn}(w), & \text{if } \eta|w| \geq \varepsilon \\ -\frac{\eta^2}{1-k} \cdot \frac{w}{\varepsilon}, & \text{if } \eta|w| < \varepsilon \end{cases}$$

The derivative of  $V(x) = x^T P x$  along the trajectories of the perturbed system satisfies

$$\dot{V} \leq -x^T x + \frac{\varepsilon}{4}$$

Thus,

$$\dot{V} \leq -(1 - \theta)x^T x, \quad \forall \|x\|_2 \geq \sqrt{\frac{\varepsilon}{4\theta}}$$

where  $0 < \theta < 1$ . For  $\theta = 0.9$ ,  $\|x\|_2$  is uniformly ultimately bounded by

$$\frac{1}{2} \sqrt{\frac{\lambda_{\max}(P)}{\lambda_{\min}(P)}} \sqrt{\frac{\varepsilon}{\theta}} = 1.2724\sqrt{\varepsilon}$$

To ensure that  $|x_1| \leq 0.01$  and  $|x_2| \leq 0.01$ , choose  $\varepsilon$  such that  $1.2724\sqrt{\varepsilon} \leq 0.01$ . In particular, take  $\varepsilon = 0.6 \times 10^{-4}$ .

## 《非线性系统（第三版）》习题解答

• 14.15 Take

$$u = \hat{c}\sqrt{y} + \hat{A}(y)(-2\zeta\omega_n e - \omega_n^2\sigma + v)$$

$$\begin{aligned} \dot{e} &= \frac{1}{A(y)} [\hat{c}\sqrt{y} + \hat{A}(y)(-2\zeta\omega_n e - \omega_n^2\sigma + v) - c\sqrt{y}] \\ &= \frac{1}{A(y)} [(\hat{c} - c)\sqrt{y} + [\hat{A}(y) - A(y)](-2\zeta\omega_n e - \omega_n^2\sigma + v)] + (-2\zeta\omega_n e - \omega_n^2\sigma + v) \\ &= -2\zeta\omega_n e - \omega_n^2\sigma + v + \delta \end{aligned}$$

where

$$\begin{aligned} \delta &= \frac{1}{A(y)} [(\hat{c} - c)\sqrt{y}] + \frac{\hat{A}(y) - A(y)}{A(y)} (-2\zeta\omega_n e - \omega_n^2\sigma + v) \\ |\delta| &\leq \frac{\varrho_3}{\varrho_1} \sqrt{y} + \varrho_4 |2\zeta\omega_n e + \omega_n^2\sigma| + \varrho_4 |v| \\ &\leq \rho(e, y, \sigma) + \varrho_4 |v| \end{aligned}$$

where

$$\rho(e, y, \sigma) = \frac{\varrho_3}{\varrho_1} \sqrt{y} + \varrho_4 |2\zeta\omega_n e + \omega_n^2\sigma|$$

The closed-loop system is given by

$$\begin{bmatrix} \dot{e} \\ \dot{\sigma} \end{bmatrix} = \begin{bmatrix} -2\zeta\omega_n & -\omega_n^2 \\ 1 & 0 \end{bmatrix} \begin{bmatrix} e \\ \sigma \end{bmatrix} + \begin{bmatrix} 1 \\ 0 \end{bmatrix} (v + \delta)$$

We can now design  $v$  as described in Section 14.2.1 to achieve ultimate boundedness with an ultimate bound that can be made arbitrarily small by choosing  $\varepsilon$  small enough. Therefore, we can ensure that the tracking error  $|y - r| < \mu$  for  $t \geq T$ , for any specified  $\mu$ .

• 14.16

• 14.17 (1)

$$\dot{x} = -x + x^2[u + \delta]$$

It takes the form (14.47) with  $f = -x$ ,  $G = x^2$ , and  $\Gamma = 1$ . Take  $\psi = 0$  and  $V = \frac{1}{2}x^2$ . Then,  $w = x^3$ . From (14.48),  $v = -\gamma x^3$ ,  $\gamma > 0$ .

(2)

$$\dot{x} = x^2 - x[u - x\delta]$$

It takes the form (14.47) with  $f = x^2$ ,  $G = -x$ , and  $\Gamma = -x$ . Take  $\psi = x + x^2$  and  $V = \frac{1}{2}x^2$ . Then,  $w = -x^2$ . From (14.48),  $v = \gamma x^4$ ,  $\gamma > 0$ .

• 14.18

$$\dot{\eta} = f_0(\eta, \xi), \quad \dot{\xi} = A_c \xi + B_c \gamma(x)[u - \alpha(x)], \quad y = C_c \xi$$

Let

$$e_1 = y - r, \quad e_2 = \dot{y} - \dot{r}, \dots$$

Then

$$\dot{e} = A_c e + B_c \gamma(x)[u - \alpha(x)] - B_c r^{(\rho)}$$

Take

$$u = \hat{\alpha}(x) + \frac{1}{\hat{\gamma}(x)} [r^{(\rho)} - K e + v]$$

## 《非线性系统（第三版）》习题解答

where  $K$  is designed such that  $A_c - B_c K$  is Hurwitz.

$$\dot{e} = (A_c - B_c K)e + B_c(v + \delta)$$

where

$$\delta = \gamma[\hat{\alpha} - \alpha] + \frac{\gamma - \hat{\gamma}}{\hat{\gamma}} (r^{(\rho)} - Ke + v)$$

$$|\delta| \leq \rho_0(x) + k|r^{(\rho)}| + k\|K\|_2\|e\|_2 + k|v| \stackrel{\text{def}}{=} \rho(t, x) + k|v|$$

We can now design  $v$  as described in Section 14.2.1 to achieve ultimate boundedness with an ultimate bound that can be made arbitrarily small by choosing  $\varepsilon$  small enough. Therefore, we can ensure that the tracking error  $|y - r| < \mu$  for  $t \geq T$ , for any specified  $\mu$ .

• 14.19 The solution is similar to the previous exercise.

• 14.20 (a) The nominal system

$$\dot{x}_1 = x_2, \quad \dot{x}_2 = -x_1 - x_2$$

has a Lyapunov function  $V(x) = x^T P x = 1.5x_1^2 + x_1 x_2 + x_2^2$ , where  $P$  satisfies the Lyapunov equation  $PA + A^T P = -I$ . With this Lyapunov function, we have  $w = 2x^T P B = x_1 + 2x_2$ .

$$\dot{V} = -\|x\|_2^2 + w^T(v + \delta) \leq -\|x\|_2^2 - \rho_1\|x\|_2|w| + \rho_1\|x\|_2|w| \leq -\|x\|_2^2, \quad \text{for } \rho_1\|x\|_2|w| \geq \varepsilon$$

On the other hand, for  $\rho_1\|x\|_2|w| < \varepsilon$ , we have

$$\dot{V} \leq -\|x\|_2^2 + \left[ -\frac{1}{\varepsilon} (\|x\|_2 \rho_1 |w|)^2 + \|x\|_2 \rho_1 |w| \right] \leq -\|x\|_2^2 + \frac{\varepsilon}{4} \leq -\frac{1}{2}\|x\|_2^2, \quad \text{for } \|x\|_2^2 \geq \frac{\varepsilon}{2}$$

(b) Let  $\delta(x) = 2(x_1 + x_2)$ . Then,  $|\delta| \leq 2\sqrt{2}\|x\|_2$ . Choose  $\rho_1 = 2\sqrt{2}$ . The closed-loop system is given by

$$\dot{x}_1 = x_2, \quad \dot{x}_2 = x_1 + x_2 + v$$

where  $v$  is of the order  $O(\|x\|_2^3)$ . Hence, linearization at the origin yields the matrix  $\begin{bmatrix} 0 & 1 \\ 1 & 1 \end{bmatrix}$ , which has an eigenvalue in the right-half plane. Thus, the origin is unstable.

• 14.21 (a)

$$\begin{aligned} \dot{V} &\leq -\alpha_3(\|x\|_\infty) + w^T v + w^T \delta \\ &\leq -\alpha_3(\|x\|_\infty) - \sum_{i \in I} \frac{\eta^2}{\varepsilon} w_i^2 - \sum_{i \notin I} \eta |w_i| + \|w\|_1 (\rho + \kappa_0 \|v\|_\infty) \\ &\leq -\alpha_3(\|x\|_\infty) - \sum_{i \in I} \frac{(\eta |w_i|)^2}{\varepsilon} - \sum_{i \notin I} \eta |w_i| + [\eta(1 - \kappa_0) + \kappa_0 \eta] \sum_{i=1}^p |w_i| \\ &= -\alpha_3(\|x\|_\infty) + \sum_{i \in I} \left[ -\frac{(\eta |w_i|)^2}{\varepsilon} + \eta |w_i| \right] + \sum_{i \notin I} [-\eta |w_i| + \eta |w_i|] \\ &= -\alpha_3(\|x\|_\infty) + \sum_{i \in I} \left[ -\frac{(\eta |w_i|)^2}{\varepsilon} + \eta |w_i| \right] \end{aligned}$$

(b)

$$\dot{V} \leq -\alpha_3(\|x\|_\infty) + \sum_{i \in I} \frac{\varepsilon}{4} \leq -\alpha_3(\|x\|_\infty) + k_1 \varepsilon, \quad k_1 > 0$$

From this inequality, we can show ultimate boundedness as in Theorem 14.3.

## 《非线性系统（第三版）》习题解答

- 14.22 (a) Repeating the calculation of the previous exercise, we have

$$\begin{aligned}
 \dot{V} &\leq -\phi^2 + \sum_{i \in I} \left[ -\frac{(\eta|w_i|)^2}{\varepsilon} + |w_i|\rho_1\phi + \frac{\kappa_0\eta^2|w_i|^2}{\varepsilon} \right] \\
 &= -\phi^2 + \sum_{i \in I} \left[ -(1-\kappa_0)\frac{(\eta|w_i|)^2}{\varepsilon} + |w_i|\rho_1\phi \right] \\
 &\leq -\phi^2 + \sum_{i \in I} \left[ -(1-\kappa_0)\frac{(\eta_0|w_i|)^2}{\varepsilon} + |w_i|\rho_1\phi \right]
 \end{aligned}$$

(b)

$$\dot{V} \leq -\frac{1}{2}\phi^2 + \left\{ -\frac{1}{2}\phi^2 + \sum_{i \in I} \left[ -(1-\kappa_0)\frac{(\eta_0|w_i|)^2}{\varepsilon} + |w_i|\rho_1\phi \right] \right\}$$

The quadratic form in the braces can be made negative definite by choosing  $\varepsilon$  small enough. Therefore,  $\dot{V} \leq -\frac{1}{2}\phi^2$ , which shows that the origin is asymptotically stable.

- 14.23 (a)

$$\begin{aligned}
 \dot{V} &\leq -\phi^2 - \frac{\eta_0 + \eta_1\phi}{\varepsilon} \|w\|_2^2 + (\rho_0 + \rho_1\phi)\|w\|_2 + \kappa_0 \frac{\eta_0 + \eta_1\phi}{\varepsilon} \|w\|_2^2 \\
 &= -\phi^2 - \frac{1}{\varepsilon}(1-\kappa_0)(\eta_0 + \eta_1\phi)\|w\|_2^2 + (\rho_0 + \rho_1\phi)\|w\|_2 \\
 &\leq -\phi^2 + (\rho_0 + \rho_1\phi) \left[ -\frac{1}{\varepsilon}\|w\|_2^2 + \|w\|_2 \right] \\
 &\leq -\phi^2 + \frac{\varepsilon}{4}(\rho_0 + \rho_1\phi) \\
 &= -\frac{1}{2}\phi^2 - \frac{1}{2} \left[ \phi - \frac{\varepsilon\rho_1}{4} \right]^2 + \frac{\varepsilon^2\rho_1^2}{32} + \frac{\varepsilon\rho_0}{4} \\
 &\leq -\frac{1}{2}\alpha_3(\|x\|_2) + \frac{\varepsilon^2\rho_1^2}{32} + \frac{\varepsilon\rho_0}{4}
 \end{aligned}$$

- 14.24 The closed-loop system is

$$\dot{x} = f + G(\psi - \gamma w + \delta)$$

$$\begin{aligned}
 \dot{V} &= \frac{\partial V}{\partial t} + \frac{\partial V}{\partial x}(f + G\psi) + \frac{\partial V}{\partial x}G(-\gamma w + \delta) \leq -\alpha_3(\|x\|_2) - \gamma\|w\|_2^2 + \|w\|_2(\rho_1\phi(x) + \kappa_0\gamma\|w\|_2) \\
 &\leq -\phi^2(x) - \gamma(1-\kappa_0)\|w\|_2^2 + \rho_1\phi(x)\|w\|_2 = - \begin{bmatrix} \phi(x) \\ \|w\|_2 \end{bmatrix}^T \begin{bmatrix} 1 & -\frac{1}{2}\rho_1 \\ -\frac{1}{2}\rho_1 & \gamma(1-\kappa_0) \end{bmatrix} \begin{bmatrix} \phi(x) \\ \|w\|_2 \end{bmatrix}
 \end{aligned}$$

Taking  $\gamma > \rho_1^2/4(1-\kappa_0)$  ensures that  $\dot{V}$  is negative definite.

- 14.25 Starting with the system

$$\dot{x} = f + G(u + \delta)$$

add and subtract the term  $\psi$  to obtain

$$\dot{x} = (f + G\psi) + G(u + \delta - \psi)$$

View  $\delta - \psi$  as the perturbation term and proceed to design  $u = v$ .

## 《非线性系统（第三版）》习题解答

• 14.26

$$\dot{x} = (f + G\psi) + \Delta + G(v + \delta)$$

Outside the boundary layer, we have

$$\dot{V} \leq -\phi^2 + w^T(v + \delta) + \frac{\partial V}{\partial x} \Delta \leq -(1 - \mu)\phi^2$$

The right-hand side is negative definite for  $\mu < 1$ . Inside the boundary layer, we have

$$\dot{V} \leq -(1 - \mu)\phi^2 + \rho_1 \phi \|w\|_2 - (1 - \kappa_0) \frac{\eta_0^2}{\varepsilon} \|w\|_2^2$$

The quadratic form can be made negative definite by choosing  $\varepsilon < 4(1 - \mu)(1 - \kappa_0)\eta_0^2/\rho_1^2$ . Therefore, the origin is asymptotically stable.

• 14.27

(a) Take  $u = \psi(x) + v$ , where

$$v = \begin{cases} -\frac{\eta_1 \rho^2(x) + \eta_0}{\|x\|_2} w & \text{if } \|x\|_2 \geq 1 \\ -[\eta_1 \rho^2(x) + \eta_0] w & \text{if } \|x\|_2 < 1 \end{cases}$$

where  $w^T = \frac{\partial V}{\partial x} G$ , and  $\eta_0, \eta_1$  are positive constants to be chosen. Use  $V$  as a Lyapunov function candidate. For  $\|x\|_2 \geq 1$ , we have

$$\begin{aligned} \dot{V} &= \frac{\partial V}{\partial x} (f + G\psi) + w^T(v + \delta) \\ &\leq -c_3 \|x\|_2^2 - \frac{\eta_1 \rho^2 + \eta_0}{\|x\|_2} \|w\|_2^2 + \rho \|w\|_2 + \kappa_0 \frac{\eta_1 \rho^2 + \eta_0}{\|x\|_2} \|w\|_2^2 \\ &= -c_3 \|x\|_2^2 - (1 - \kappa_0) \frac{\eta_1 \rho^2 + \eta_0}{\|x\|_2} \|w\|_2^2 + \rho \|w\|_2 \\ &\leq -\frac{c_3}{2} \|x\|_2^2 - \frac{c_3}{2} \|x\|_2^2 - (1 - \kappa_0) \frac{\eta_1 \rho^2}{\|x\|_2} \|w\|_2^2 + \rho \|w\|_2 \end{aligned}$$

Using  $\|x\|_2^2 \geq \|x\|_2$  for  $\|x\|_2 \geq 1$ , we obtain

$$\dot{V} \leq -\frac{c_3}{2} \|x\|_2^2 - \frac{1}{\|x\|_2} \left[ (1 - \kappa_0) \eta_1 (\rho \|w\|_2)^2 - (\rho \|w\|_2) \|x\|_2 + \frac{c_3}{2} \|x\|_2^2 \right]$$

Choosing  $\eta_1 > 1/[2c_3(1 - \kappa_0)]$  yields

$$\dot{V} \leq -\frac{c_3}{2} \|x\|_2^2$$

For  $\|x\|_2 < 1$ , note that there is  $\rho_1 > 0$  such that  $\rho(x) \leq \rho_1 \|x\|_2$  for all  $\|x\|_2 \leq 1$ .

$$\begin{aligned} \dot{V} &= \frac{\partial V}{\partial x} (f + G\psi) + w^T(v + \delta) \\ &\leq -c_3 \|x\|_2^2 - (\eta_1 \rho^2 + \eta_0) \|w\|_2^2 + \rho_1 \|w\|_2 \|x\|_2 + \kappa_0 (\eta_1 \rho^2 + \eta_0) \|w\|_2^2 \\ &= -c_3 \|x\|_2^2 - (1 - \kappa_0) (\eta_1 \rho^2 + \eta_0) \|w\|_2^2 + \rho_1 \|w\|_2 \|x\|_2 \\ &\leq -\frac{c_3}{2} \|x\|_2^2 - (1 - \kappa_0) \left( \eta_0 \|w\|_2^2 - \rho_1 \|x\|_2 \|w\|_2 + \frac{c_3}{2} \|x\|_2^2 \right) \end{aligned}$$

Choosing  $\eta_0 > \rho_1^2/[2c_3(1 - \kappa_0)]$  yields

$$\dot{V} \leq -\frac{c_3}{2} \|x\|_2^2$$

## 《非线性系统（第三版）》习题解答

Therefore, the origin is globally exponentially stable.

(b) Set

$$f(x) = \begin{bmatrix} x_2 \\ x_1^3 + x_2^3 \end{bmatrix}, G = \begin{bmatrix} 0 \\ 1 \end{bmatrix}, \delta(x, u) = a_1(x_1^3 + x_2^3) + a_2u$$

Take  $\psi(x) = -(x_1^3 + x_2^3) - x_1 - 2x_2$ . Then

$$\dot{x} = f(x) + G(x)\psi(x) = \begin{bmatrix} 0 & 1 \\ -1 & -2 \end{bmatrix} x$$

is globally exponentially stable with  $V(x) = x^T P x = x^T \begin{bmatrix} 3/2 & 1/2 \\ 1/2 & 1/2 \end{bmatrix} x$  and  $c_1 = \lambda_{\min}(P) = 1 - 1/\sqrt{2}$ ,  $c_2 = \lambda_{\max}(P) = 1 + 1/\sqrt{2}$ , and  $c_3 = 1$ .

$$\delta(x, \psi(x) + v) = a_1(x_1^3 + x_2^3) + a_2[-(x_1^3 + x_2^3) - (x_1 + 2x_2) + v] = (a_1 - a_2)(x_1^3 + x_2^3) - a_2(x_1 + 2x_2) + a_2v$$

$$|\delta(x, \psi(x) + v)| \leq \frac{3}{2}|x_1^3 + x_2^3| + \frac{1}{2}|x_1 + 2x_2| + \frac{1}{2}|v|$$

Take

$$\rho(x) = \frac{3}{2}|x_1^3 + x_2^3| + \frac{1}{2}|x_1 + 2x_2|, \quad \kappa_0 = \frac{1}{2}$$

Clearly,

$$\rho(x) \leq \frac{3}{2}\|x\|_2^3 + \frac{\sqrt{5}}{2}\|x\|_2$$

Therefore, for  $\|x\|_2 \leq 1$ , we have  $\rho(x) \leq \rho_1\|x\|_2$ , where  $\rho_1 = (3 + \sqrt{5})/2$ . Choose  $\eta_0$  and  $\eta_1$  such that  $\eta_0 > \rho_1^2/[2c_3(1 - \kappa_0)]$  and  $\eta_1 > 1/[2c_3(1 - \kappa_0)]$ . Take  $\eta_0 = 10$  and  $\eta_1 = 2$ . The design is now complete.

• 14.28 (a) Consider  $\dot{x}_1 = x_2 + \sin x_1$  and view  $x_2$  as the control input. With  $x_2 = -2x_1$  and  $V = \frac{1}{2}x_1^2$  we have  $\dot{V} \leq -x_1^2$ . Now set  $z = x_2 + 2x_1$  and  $V_a = \frac{1}{2}x_1^2 + \frac{1}{2}z^2$ .

$$\begin{aligned} \dot{V}_a &= x_1(x_2 + \sin x_1) + z[\theta_1 x_1^2 + (1 + \theta_2)u + 2x_2 + 2\sin x_1] \\ &= x_1(-2x_1 + \sin x_1) + z[x_1 + \theta_1 x_1^2 + (1 + \theta_2)u + 2x_2 + 2\sin x_1] \end{aligned}$$

Take  $u = -x_1 - 2x_2 - 2\sin x_1 - z + v$  to obtain

$$\dot{V}_a \leq -x_1^2 - z^2 + z(v + \delta)$$

where

$$\delta = \theta_1 x_1^2 - \theta_2(3x_1 + 3x_2 + 2\sin x_1) + \theta_2 v \leq \rho(x) + \frac{1}{2}|v|$$

where  $\rho(x) = 2x_1^2 + \frac{1}{2}|3x_1 + 3x_2 + 2\sin x_1|$ . Take  $\eta(x) \geq \rho(x)/(1 - 0.5) = 2\rho(x)$  such that  $\eta(x) \geq \eta_0 > 0$ . Using Lyapunov redesign, take

$$v = \begin{cases} -\eta \operatorname{sgn}(z), & \text{if } \eta|z| \geq \varepsilon \\ -\frac{\eta^2}{\varepsilon} z & \text{if } \eta|z| < \varepsilon \end{cases}$$

which yields

$$\dot{V}_a \leq -x_1^2 - z^2 + \frac{\varepsilon(1 - 0.5)}{4} = -x_1^2 - z^2 + \frac{\varepsilon}{8}$$

## 《非线性系统（第三版）》习题解答

Near the origin,  $|\rho(x)| \leq k_1|x_1| + k_2|z|$ . This can be used to show that the origin is asymptotically stable for sufficiently small  $\varepsilon$ . In particular, near the origin

$$\begin{aligned} \dot{V}_\varepsilon &\leq -x_1^2 - z^2 + |z|(k_1|x_1| + k_2|z|) - \frac{\eta^2}{2\varepsilon}|z|^2 \\ &\leq -x_1^2 - z^2 - \frac{\eta_0^2}{2\varepsilon}|z|^2 + |z|(k_1|x_1| + k_2|z|) \end{aligned}$$

The RHS is negative definite for sufficiently small  $\varepsilon$ .

(b) Define  $e_1 = x_1 - r$  and  $e_2 = \dot{x}_1 - \dot{r} = x_2 + \sin x_1 - \dot{r}$  to obtain

$$\dot{e}_1 = e_2, \quad \dot{e}_2 = \theta_1 x_1^2 + (1 + \theta_2)u + (x_2 + \sin x_1) \cos x_1 - \ddot{r}$$

Proceed as in part (a) to design a state feedback control that drives  $e$  towards zero. This time however you can only achieve ultimate boundedness.

### • 14.29

$$\dot{x}_1 = x_2, \quad \dot{x}_2 = -a \sin x_1 - bx_2 + cu + \zeta(t) \cos x_1$$

Consider the equation  $\dot{x}_1 = x_2$  and view  $x_2$  as the control input. The origin  $x_1 = 0$  can be stabilized by  $x_2 = -x_1$  with the Lyapunov function  $V_1 = x_1^2/2$ . Apply the change of variables  $z_1 = x_1$  and  $z_2 = x_2 + x_1$ , to obtain

$$\dot{z}_1 = -z_1 + z_2, \quad \dot{z}_2 = -a \sin x_1 - bx_2 + cu + \zeta(t) \cos x_1 - x_1 + z_2$$

Take  $V = x_1^2/2 + z_2^2/2 = z_1^2/2 + z_2^2/2$ .

$$\dot{V} = -z_1^2 + z_2[x_1 - a \sin x_1 - bx_2 + cu + \zeta(t) \cos x_1 - x_1 + z_2]$$

Take  $u = -4z_2 + v$ , to obtain

$$\dot{V} = -z_1^2 - (4c - 1)z_2^2 + z_2c[\delta + v] \leq -z_1^2 - z_2^2 + z_2c[\delta + v]$$

where we used the fact that  $(4c - 1) \geq (4 \times 0.551 - 1) > 1$ , and

$$\delta = \frac{1}{c}[-a \sin x_1 - bx_2 + \zeta(t) \cos x_1]$$

satisfies the bound

$$|\delta| \leq 16.1865|x_1| + 0.242|x_2| + 1.1111 \stackrel{\text{def}}{=} \eta$$

Take

$$v = \begin{cases} -\eta \operatorname{sgn}(z_2), & \text{if } \eta|z_2| \geq \varepsilon \\ -\frac{\eta^2 z_2}{\varepsilon}, & \text{if } \eta|z_2| < \varepsilon \end{cases}$$

which yields

$$\dot{V} \leq -z_1^2 - z_2^2 + \frac{\varepsilon}{4} \leq -(1 - \theta)\|z\|_2^2, \quad \forall \|z\|_2 \geq \sqrt{\frac{\varepsilon}{4\theta}}$$

where  $0 < \theta < 1$ . For  $\theta = 0.9$ ,  $\|z\|_2$  is uniformly ultimately bounded by

$$\frac{1}{2} \sqrt{\frac{\varepsilon}{\theta}} = 0.527\sqrt{\varepsilon}$$

Using the fact that

$$x = \begin{bmatrix} 1 & 0 \\ -1 & 1 \end{bmatrix} z \Rightarrow \|x\|_2 \leq 1.618\|z\|_2$$

choose  $\varepsilon$  such that  $0.527\sqrt{\varepsilon} \leq 0.01/1.618$  to ensure that  $\|x\|_2 \leq 0.01$ . In particular, take  $\varepsilon = 10^{-4}$ .

## 《非线性系统（第三版）》习题解答

- **14.30** We start with the scalar system  $\dot{x}_1 = x_1 x_2$  and view  $x_2$  as the control input. We can globally stabilize the origin with  $x_2 = -x_1^2$  which results in  $\dot{x}_1 = -x_1^3$ . A Lyapunov function can be taken as  $V(x_1) = \frac{1}{2}x_1^2$ . Now consider

$$V_a(x) = \frac{1}{2}x_1^2 + \frac{1}{2}(x_2 + x_1^2)^2$$

$$\dot{V}_a = x_1 \dot{x}_1 + (x_2 + x_1^2)(\dot{x}_2 + 2x_1 \dot{x}_1) = x_1(x_1 x_2) + (x_2 + x_1^2)(x_1 + u + 2x_1^2 x_2)$$

Add and subtract  $-x_1^4$ .

$$\dot{V}_a = -x_1^4 + (x_2 + 2x_1)(x_1^2 + x_1 + u + 2x_1^2 x_2)$$

Take

$$u = -(x_1^2 + x_1 + 2x_1^2 x_2) - (x_2 + 2x_1) = -(x_1 + x_2 + 2x_1^2 x_2)$$

$$\dot{V} = -x_1^4 - (x_2 + x_1^2)^2$$

which shows that the origin is globally asymptotically stable.

- **14.31** The system is in the form (14.53)-(14.54) with

$$f = a + (x_1 - a^{1/3})^3, \quad g = 1, \quad f_a = x_1, \quad g_a = 1$$

Take  $\phi(x_1) = -a - (x_1 - a^{1/3})^3 - x_1$  and  $V = \frac{1}{2}x_1^2$ . Use (14.56).

- **14.32** See Section 2.4.3 of [108].

- **14.33 (a)** The system is feedback linearizable. Take  $u = -2x_1 + x_1^3 - x_2 \stackrel{\text{def}}{=} \phi(x)$ . Then,  $\dot{x} = Ax$  where  $A = \begin{bmatrix} 0 & 1 \\ -1 & -1 \end{bmatrix}$  is Hurwitz. Hence, the origin is globally exponentially stable.

(b) Let  $\xi = z - \phi(x)$ .

$$\dot{x} = Ax + B\xi, \quad \dot{\xi} = v - \frac{\partial \phi}{\partial x}(Ax + B\xi)$$

where  $B = \begin{bmatrix} 0 \\ 1 \end{bmatrix}$ . Let  $V = x^T P x + \frac{1}{2}\xi^2$ .

$$\dot{V} = -x^T P x + 2x^T P B \xi + \xi \left[ v - \frac{\partial \phi}{\partial x}(Ax + B\xi) \right]$$

Take

$$v = \frac{\partial \phi}{\partial x}(Ax + B\xi) - 2x^T P B \xi - \xi$$

$$\dot{V} = -x^T P x - \xi^2$$

which shows that the origin [in the coordinates  $(x, \xi)$ ] is globally exponentially stable. Note that in the original coordinates  $(x, z)$  we can only conclude global asymptotic stability due to the nonlinear change of variables  $\xi = z - \phi(x)$ .

- **14.34** Start with  $\dot{x}_1 = -x_1 + x_2$  and view  $x_2$  as the control input. We can take  $\phi_1(x) = 0$  which results in  $\dot{x}_1 = -x_1$ . A Lyapunov function can be taken as  $V_1 = \frac{1}{2}x_1^2$ . Now, let  $V_a = \frac{1}{2}(x_1^2 + x_2^2)$ .

$$\dot{V}_a = x_1(-x_1 + x_2) + x_2(x_1 - x_2 - x_1 x_3 + u)$$

Take  $u = -2x_1 + x_1 x_3$ .

$$\dot{V}_a = -x_1^2 - x_2^2$$



## 《非线性系统（第三版）》习题解答

which implies that the origin of the second-order system

$$\dot{x}_1 = -x_1 + x_2, \quad \dot{x}_2 = -x_1 - x_2$$

is globally exponentially stable. From the third equation

$$\dot{x}_3 = -2x_3 + x_1 + x_1x_2$$

it is clear that the origin of the full system is globally asymptotically stable.

• **14.35** Treat  $\theta$  as an unknown parameter, but assume that  $a$  will be available on line. Our design, however, should work with any  $a$  that satisfies  $|a| \leq 1$ . Start with  $\dot{x}_1 = x_2 + \theta x_1^2$  and view  $x_2$  as the control input. Let  $e_1 = x_1 - a \sin t$ . Then,

$$\dot{e}_1 = x_2 + \theta x_1^2 - a \cos t$$

Take  $x_2 = -k_1 e_1 + a \cos t \stackrel{\text{def}}{=} \phi_1(e_1, t)$  where  $k_1 > 0$ . With  $V_1 = \frac{1}{2} e_1^2$ , we have

$$\begin{aligned} \dot{V}_1 &= -k_1 e_1^2 + \theta e_1 x_1^2 \leq -k_1 e_1^2 + 2|e_1||x_1|^2 \\ &\leq -k_1 e_1^2 + 2|e_1|(|e_1| + a)^2 \leq -k_1^2 e_1^2 + 2|e_1|^3 + 4|e_1|^2 + 2|e_1| \end{aligned}$$

By choosing  $k_1$  sufficiently large, we can make  $e_1$  ultimately bounded and the ultimate bound can be made arbitrarily small. Now, proceed to the second step of the backstepping procedure. Let  $z_1 = e_1$  and  $z_2 = x_2 - \phi_1(e_1, t) = x_2 + k_1 e_1 - a \cos t$ .

$$\dot{z}_1 = -k_1 z_1 + \theta x_1^2 + z_2, \quad \dot{z}_2 = x_3 + u + k_1(-k_1 z_1 + \theta x_1^2 + z_2) + a \sin t$$

Let  $V_a = \frac{1}{2} z_1^2 + \frac{b^2}{2} z_2^2$ . The reason for including the constant  $b$  will be revealed shortly.

$$\dot{V}_a = z_1(-k_1 z_1 + \theta x_1^2 + z_2) + b^2 z_2 [x_3 + u + k_1(-k_1 z_1 + \theta x_1^2 + z_2) + a \sin t]$$

Take

$$u = -[x_3 + k_1(-k_1 z_1 + z_2) + a \sin t] - \frac{1}{b^2}(z_1 + k_2 z_2)$$

$$\begin{aligned} \dot{V}_a &= -k_1 z_1^2 + \theta z_1 x_1^2 + b^2 k_1 \theta x_1^2 z_2 - k_2 z_2^2 \\ &\leq -k_1 z_1^2 + 2|z_1|(|z_1| + a)^2 + 2b^2 k_1 (|z_1| + a)^2 |z_2| - k_2 z_2^2 \\ &\leq -k_1 z_1^2 + 2|z_1|^3 + 4|z_1|^2 + 2|z_1| + 2b^2 k_1 (|z_1|^2 + 2|z_1| + 1)|z_2| - k_2 z_2^2 \end{aligned}$$

Due to the cubic terms on the right-hand side, we need to limit our analysis to a compact set. Let  $\Omega = \{V_a(z) \leq c\}$ . Choose  $c > 0$  such that  $z(0) \in \Omega$ . Using the fact that  $\|x(0)\|_\infty \leq 1$ , we have

$$|z_1(0)| = |x_1(0)| \leq 1$$

$$|z_2(0)| = |x_2(0) + k_1 e_1(0) - a| \leq 1 + k_1 + a \leq 2 + k_1$$

The initial state  $z_2(0)$  depends on  $k_1$ . To be able to choose  $c$  independent of  $k_1$ , we have included the coefficient  $b^2$  in the Lyapunov function. Take  $b = 1/(2 + k_1)$ . Then

$$V_a(z(0)) = \frac{1}{2} z_1^2(0) + \frac{1}{2(2 + k_1)^2} z_2^2(0) \leq \frac{1}{2} + \frac{1}{2} = 1$$

Therefore, we take  $c = 1$  and limit our analysis to the set  $\Omega = \{V_a(z) \leq 1\}$ . Notice that  $|z_1| \leq \sqrt{2}$  in  $\Omega$ . Therefore

$$2|z_1|^3 + 4|z_1|^2 + 2|z_1| \leq (2\sqrt{2} + 4)|z_1|^2 + 2|z_1|$$

## 《非线性系统（第三版）》习题解答

$$2b^2k_1(|z_1|^2 + 2|z_1| + 1)|z_2| \leq (2 + \sqrt{2})|z_1||z_2| + |z_2|$$

where we have used the fact that  $k_1/(2 + k_1)^2 \leq 1/2$ . Thus,

$$\dot{V}_a \leq -k_1z_1^2 + (2\sqrt{2} + 4)z_1^2 + 2|z_1| - k_2z_2^2 + (\sqrt{2} + 2)|z_1||z_2| + |z_2|$$

Take  $k_1 = 2\sqrt{2} + 4 + 2\alpha$  and  $k_2 = 2\alpha$ , where  $\alpha > 0$ . Then

$$\dot{V}_a \leq -\alpha\|z\|_2^2 + \sqrt{5}\|z\|_2 + [-\alpha\|z\|_2^2 + (\sqrt{2} + 2)|z_1||z_2|]$$

By choosing  $\alpha$  large enough, we can make the bracketed term negative definite. Hence,

$$\dot{V}_a \leq -\alpha\|z\|_2^2 + \sqrt{5}\|z\|_2 \leq -(1 - \beta)\alpha\|z\|_2^2, \quad \forall \|z\|_2 \geq \sqrt{5}/\alpha\beta, \quad 0 < \beta < 1$$

which shows that  $z$  is uniformly ultimately bounded and the ultimate bound is proportional to  $1/\alpha$ . By choosing  $\alpha$  sufficiently large, we can make the ultimate bound arbitrarily small. Finally, notice from the  $\dot{x}_3$  equation that boundedness of  $x_1$  implies boundedness of  $x_3$ .

• 14.36

• 14.37 Apply backstepping to deal with the nominal system and then Lyapunov redesign to take care of the uncertain term  $\delta$ . Start with  $\dot{x}_1 = -x_1 + x_1x_2$ . Using  $V_1 = \frac{1}{2}x_1^2$ , we take  $x_2 = 0$  to obtain  $\dot{V}_1 = -x_1^2$ . Now consider

$$\dot{x}_1 = -x_1 + x_1x_2, \quad \dot{x}_2 = x_2 + x_2$$

Take  $V_2 = \frac{1}{2}x_1^2 + \frac{1}{2}x_2^2$ .

$$\dot{V}_2 = -x_1^2 + x_2(x_1^2 + x_2 + x_3)$$

Take  $x_3 = -x_1^2 - 2x_2^2$  to obtain

$$\dot{V}_2 = -x_1^2 - x_2^2$$

Now consider the whole system with

$$V = \frac{1}{2}x_1^2 + \frac{1}{2}x_2^2 + \frac{1}{2}(x_3 + x_1^2 + 2x_2)^2$$

$$\dot{V} = -x_1^2 - x_2^2 + (x_3 + x_1^2 + x_2^2)\{-\alpha(x) + \delta(x) + u\}$$

where  $\alpha(x)$  is known. Take

$$u = \alpha(x) - (x_3 + x_1^2 + x_2^2) + v$$

to obtain

$$\dot{V} = -x_1^2 - x_2^2 - (x_3 + x_1^2 + x_2^2)^2 + w(\delta + v)$$

where  $w = x_3 + x_1^2 + x_2^2$ . Now apply Lyapunov redesign to finish the problem.

• 14.38 (a) Consider the system

$$\dot{x}_1 = -x_1 + \tanh x_2, \quad \dot{x}_2 = x_2 + x_3$$

and view  $x_3$  as a control input. We saw in Exercise 14.7 that  $x_3 = -2x_2$  globally stabilizes the origin with  $V = (1/2)(x_1^2 + x_2^2)$  as a Lyapunov function. To backstep, let  $z_3 = x_3 + 2x_2$ .

$$\dot{x}_1 = -x_1 + \tanh x_2, \quad \dot{x}_2 = -x_2 + z_3, \quad \dot{z}_3 = 2x_2 + 2z_3 + u$$

Let  $V_a = (1/2)(x_1^2 + x_2^2 + z_3^2)$ .

$$\dot{V}_a \leq -\frac{1}{2}(x_1^2 + x_2^2) + x_2z_3 + z_3(2x_2 + 2z_3 + u)$$

## 《非线性系统（第三版）》习题解答

$$u = -3x_2 - 2x_3 - z_3 \Rightarrow \dot{V}_a \leq -\frac{1}{2}(x_1^2 + x_2^2) - z_3^2$$

(b) With  $\delta \neq 0$ , we have

$$\dot{x}_1 = -x_1 + \tanh x_2, \quad \dot{x}_2 = -x_2 + z_3, \quad \dot{z}_3 = 2x_2 + 2x_3 + u + \delta$$

$$\dot{V}_a \leq -\frac{1}{2}(x_1^2 + x_2^2) + x_2 z_3 + z_3(2x_2 + 2x_3 + u + \delta)$$

$$u = -3x_2 - 2x_3 - z_3 + v \Rightarrow \dot{V}_a \leq -\frac{1}{2}(x_1^2 + x_2^2) - z_3^2 + z_3(v + \delta)$$

Take

$$v = \begin{cases} -\rho(x) \operatorname{sgn}(z_3), & \text{if } \rho(x)|z_3| \geq \varepsilon \\ -\frac{\rho^2(x)z_3}{\varepsilon}, & \text{if } \rho(x)|z_3| < \varepsilon \end{cases}$$

For  $\rho(x)|z_3| \geq \varepsilon$ ,  $z_3(v + \delta) \leq 0$ , while for  $\rho(x)|z_3| < \varepsilon$ ,  $z_3(v + \delta) \leq \varepsilon/4$ . thus,

$$\dot{V}_a \leq -\frac{1}{2}(x_1^2 + x_2^2) - z_3^2 + \frac{\varepsilon}{4} \leq -\frac{1}{2}(1 - \theta)\|z\|_2^2, \quad \forall \|z\|_2 \geq \sqrt{\frac{2\varepsilon}{\theta}}$$

where  $z = [x_1, x_2, z_3]^T$  and  $0 < \theta < 1$ . The conditions of Theorem 4.18 are satisfied with  $\|\cdot\| = \|\cdot\|_2$ ,  $\alpha_1(r) = \alpha_2(r) = (1/2)r^2$ , and  $\mu = \sqrt{(2\varepsilon)/\theta}$ . Thus,  $\|z\|_2$  is ultimately bounded by  $\alpha_1^{-1}(\alpha_2(\mu)) = \mu$ . Consequently,  $|x_1|$  is ultimately bounded by  $\mu$ . Choose  $\varepsilon$  such that  $\mu \leq 0.01$ .

$$\sqrt{\frac{2\varepsilon}{\theta}} \leq 0.01 \Leftrightarrow \varepsilon \leq \frac{\theta}{2} \times 10^{-4}$$

Take  $\theta = 0.9$  and  $\varepsilon \leq 0.45 \times 10^{-4}$ .

• 14.39 (a) Let  $x_1 = y - r$  and  $x_2 = \dot{y}$ .

$$\dot{x}_1 = x_2, \quad \dot{x}_2 = g - \frac{k}{m}x_2 + \frac{1}{m}F + \frac{1}{m}d$$

Take  $F = mg - k_1x_1 - k_2x_2 + v$ , where  $k_1$  and  $k_2$  are positive constants.

$$\dot{x} = Ax + B(v + d), \quad \text{where } A = \begin{bmatrix} 0 & 1 \\ -\frac{k_1}{m} & -\frac{(k_2+k)}{m} \end{bmatrix}, \quad B = \begin{bmatrix} 0 \\ \frac{1}{m} \end{bmatrix}$$

The matrix  $A$  is Hurwitz. Let  $P = P^T > 0$  be the solution of the Lyapunov equation  $PA + A^T P = -I$ . Take  $V = x^T P x$ ,  $w = [\partial V / \partial x] B$ , and  $v = -\gamma_0 w$ . It can be shown that

$$\dot{V} \leq -\|x\|_2^2 + \frac{d_0^2}{4\gamma_0}$$

Therefore,  $x$  is uniformly ultimately bounded by the ultimate bound

$$\frac{d_0^2}{4\gamma_0\theta} \sqrt{\frac{\lambda_{\max}(P)}{\lambda_{\min}(P)}}, \quad 0 < \theta < 1$$

Given any  $\mu$ , we can choose  $\gamma_0$  large enough to ensure that

$$\frac{d_0^2}{4\gamma_0\theta} \sqrt{\frac{\lambda_{\max}(P)}{\lambda_{\min}(P)}} < \mu$$

## 《非线性系统（第三版）》习题解答

In summary

$$\gamma(x_1, x_2) = mg - k_1 x_1 - k_2 x_2 - \gamma_0 w$$

(b) Let  $z = F - \gamma(x_1, x_2)$ .

$$\begin{aligned} \dot{x} &= Ax + B(z + d - \gamma_0 w) \\ \dot{z} &= \frac{\partial F}{\partial x_1} \dot{x}_1 + \frac{\partial F}{\partial x_3} \dot{x}_3 + \frac{\partial \gamma}{\partial x_1} \dot{x}_1 + \frac{\partial \gamma}{\partial x_2} \dot{x}_2 = \alpha_1(\cdot) + \alpha_2(\cdot)u + \alpha_3(\cdot)d \end{aligned}$$

where the functions  $\alpha_i(\cdot)$  are known and  $\alpha_2(\cdot) \neq 0$ . Let  $V_a = x^T P x + \frac{1}{2} z^2$ .

$$\dot{V}_a = -x^T x + w z + w d - \gamma_0 w^2 + z[\alpha_1(\cdot) + \alpha_2(\cdot)u + \alpha_3(\cdot)d]$$

Take  $u = -\frac{1}{\alpha_2(\cdot)}[\alpha_1(\cdot) + w - \gamma_1 z]$ .

$$\dot{V}_a \leq -x^T x + \frac{d_0^2}{4\gamma_0} - \gamma_1 |z|^2 + z\alpha_3(\cdot)d$$

It can be shown that by choosing  $\gamma_0$  and  $\gamma_1$  large enough, we can achieve ultimate boundedness and the ultimate bound can be made smaller than  $\mu$ .

• 14.40 Start with the scalar system  $\dot{x}_1 = -x_1 + x_1^2[x_2 + \delta(t)]$  and view  $x_2$  as the control input. This system takes the form (14.47) with  $f = -x_1$ ,  $G = x_1^2$ , and  $\Gamma = 1$ . Take  $\psi = 0$  so that  $f + G\psi = -x$  and  $V = \frac{1}{2}x_1^2$ . Then,  $w = x_1^3$ . Using (14.48), the control is taken as

$$x_2 = -\gamma_1 x_1^3 \stackrel{\text{def}}{=} \phi(x_1), \quad \gamma_1 > 0$$

Now Let

$$\begin{aligned} z_1 &= x_1, \quad z_2 = x_2 + \gamma_1 x_1^3 \\ \dot{z}_1 &= -z_1 + z_1^2[-\gamma_1 z_1^3 + \delta(t)] + z_1^2 z_2 \\ \dot{z}_2 &= u + 3\gamma_1 z_1^2\{-z_1 + z_1^2[-\gamma_1 z_1^3 + \delta(t)] + z_1^2 z_2\} \end{aligned}$$

Consider

$$V_a(x) = \frac{1}{2}z_1^2 + \frac{1}{2}z_2^2$$

$$\dot{V}_a = -z_1^2 + z_1^3[-\gamma_1 z_1^3 + \delta(t)] + z_1^2 z_2 + u z_2 + 3\gamma_1 z_1^2 z_2\{-z_1 + z_1^2[-\gamma_1 z_1^3 + \delta(t)] + z_1^2 z_2\}$$

Take

$$\begin{aligned} u &= -z_1^3 + 3\gamma_1 z_1^3 + 3\gamma_1^2 z_1^7 - 3\gamma_1 z_1^4 z_2 + v \\ \dot{V}_a &= -z_1^2 + z_1^3[-\gamma_1 z_1^3 + \delta(t)] + v z_2 + 3\gamma_1 z_1^4 z_2 \delta(t) \end{aligned}$$

Take

$$v = -\gamma_2 z_2 (3\gamma_1 z_1^4)^2 - z_2, \quad \gamma_2 > 0$$

$$\dot{V}_a = -z_1^2 - z_2^2 + z_1^3[-\gamma_1 z_1^3 + \delta(t)] - 9\gamma_2 \gamma_1^2 z_2^2 z_1^8 + 3\gamma_1 z_1^4 z_2 \delta(t) \leq -z_1^2 - z_2^2 + \frac{k_0^2}{4\gamma_1} + \frac{k_0^2}{4\gamma_2}$$

Therefore, the state is uniformly bounded.

• 14.41 The procedure is similar to the previous example. In the first step, we take  $x_2 = x_1 + x_1^2$  and  $V = \frac{1}{2}x_1^2$ . The final control and Lyapunov functions are

$$\begin{aligned} u &= (1 + 2z_1 + 4z_1^3)(-z_1^3 - \gamma_1 z_1^5 - z_1 z_2) + z_1^2 - z_2 - \gamma_2 z_2 (1 + 2z_1 + 4\gamma_1 z_1^3)^2 z_1^4 \\ V_a &= \frac{1}{2}z_1^2 + \frac{1}{2}z_2^2 \end{aligned}$$

where  $z_1 = x_1$ ,  $z_2 = x_2 - x_1 - x_1^2 - \gamma_1 x_1^4$ ,  $\gamma_1 > 0$ , and  $\gamma_2 > 0$ .

## 《非线性系统（第三版）》习题解答

- 14.42 Let  $C = B^T P$  and define the system

$$\dot{x} = Ax + Bu, \quad y = Cx$$

With  $V(x) = \frac{1}{2}x^T P x$ ,

$$\dot{V} = x^T (PA + A^T P)x + x^T P B u \leq y^T u$$

Hence, the system is passive. It is also zero-state observable since the pair  $(A, C)$  is observable. By Theorem 14.4, the origin is globally stabilized by  $u_i = -k \text{ sat}(y_i)$ .

- 14.43 Consider the system

$$\dot{x}_1 = x_2, \quad \dot{x}_2 = -x_1^3 + v, \quad y = x_2$$

and let  $V = \frac{1}{4}x_1^4 + \frac{1}{2}x_2^2$ .

$$\dot{V} = x_1^3 x_2 - x_1^3 x_2 + x_2 v = y v$$

Hence, the system is passive. With  $v = 0$ ,

$$y(t) \equiv 0 \Rightarrow x_2(t) \equiv 0 \Rightarrow \dot{x}_2(t) \equiv 0 \Rightarrow x_1(t) \equiv 0$$

Thus, the system is zero-state observable. Therefore, we can globally stabilize the system by  $w = -\psi(y)$ , which shows that the system

$$\dot{x}_1 = x_2, \quad \dot{x}_2 = -x_1^3 + \psi(u)$$

can be globally stabilized by  $u = -y = -x_2$ .

- 14.44 With  $u = -(b + v)/a$ , the system can be transformed into

$$\dot{\eta} = f_0(\eta, 0) + F(\eta, y)y, \quad \dot{y} = v$$

The representation  $f_0(\eta, y) = f_0(\eta, 0) + F(\eta, y)y$  is always possible. The system  $\dot{y} = v$  with output  $y$  is passive. Thus, the system takes the cascade form (14.80)–(14.82). It can be verified that all the assumptions of Theorem 14.5 are satisfied. Thus, the origin can be globally stabilized by the feedback control of (14.84).

- 14.45 With  $u = -x_1 + x_2 + x_1 x_3 + v$ , the system can be written as

$$\begin{bmatrix} \dot{x}_1 \\ \dot{x}_3 \end{bmatrix} = \begin{bmatrix} -x_1 \\ x_1 - 2x_3 \end{bmatrix} + \begin{bmatrix} 1 \\ x_1 \end{bmatrix} x_2, \quad \dot{x}_2 = v$$

which takes the cascade form (14.80)–(14.82) with  $y = x_2$  as the output. Consider the (unforced) driven system

$$\dot{x}_1 = -x_1, \quad \dot{x}_3 = x_1 - 2x_3$$

and take  $W = (\lambda/2)x_1^2 + (1/2)x_3^2$ .

$$\dot{W} = -\lambda x_1^2 + x_1 x_3 - 2x_3^2 = - \begin{bmatrix} x_1 \\ x_3 \end{bmatrix}^T \begin{bmatrix} \lambda & -1/2 \\ -1/2 & 2 \end{bmatrix} \begin{bmatrix} x_1 \\ x_3 \end{bmatrix}$$

The  $2 \times 2$  matrix is positive definite when  $\lambda > 1/8$ . Take  $\lambda = 1$ . Thus, all the conditions of Theorem 14.5 are satisfied and, by (14.84), a globally stabilizing state feedback control is given by

$$v = -(x_1 + x_1 x_3) - x_2 \Rightarrow u = -2x_1$$

## 《非线性系统（第三版）》习题解答

- 14.46 With  $u = -x_2^2 + 1 - x_2 + v$ , the system can be written as

$$\dot{x}_1 = -(1+y)x_1^3, \quad \begin{bmatrix} \dot{x}_2 \\ \dot{x}_3 \end{bmatrix} = \begin{bmatrix} x_3 \\ -x_2 + v \end{bmatrix}, \quad y = x_3$$

which takes the cascade form (14.80)–(14.82) with  $z = x_1$ . The driving system is passive, as can be seen from  $V = \frac{1}{2}(x_2^2 + x_3^2)$ .

$$\dot{V} = x_2x_3 - x_2x_3 + x_3v = yv$$

It is also zero-state observable since

$$y(t) \equiv 0 \Rightarrow \dot{x}_3(t) \equiv 0 \Rightarrow x_3(t) \equiv 0$$

For the driven system, we have  $W = \frac{1}{4}x_1^4$ . Thus, all the conditions of Theorem 14.5 are satisfied and, by (14.84), a globally stabilizing state feedback control is given by

$$v = x_1^6 - x_3 \Rightarrow u = -x_2^2 + 1 - x_2 + x_1^6 - x_3$$

- 14.47 (a)

$$\dot{y} = b + au = b - \frac{a\hat{b}}{\hat{a}} - a\beta \operatorname{sat}\left(\frac{y}{\varepsilon}\right)$$

$$y\dot{y} = a \left[ \left( \frac{b}{a} - \frac{\hat{b}}{\hat{a}} \right) y - \beta y \operatorname{sat}\left(\frac{y}{\varepsilon}\right) \right]$$

For  $|y| \geq \varepsilon$ ,

$$y\dot{y} \leq a[\varrho(y)|y| - \beta|y|] \leq -a_0\beta_0|y|$$

Hence,  $y$  reaches the boundary layer  $\{|y| \leq \varepsilon\}$  in finite time. The rest of the analysis is similar to the proof of Theorem 14.1.

(b) Similar to the proof of Theorem 14.2.

(c)  $b(\eta, y)$  and  $\hat{b}(y)$  are continuous functions. Hence, they are bounded on any compact set.  $a$  and  $\hat{a}$  are bounded from below.

(e) The system has relative degree one since  $\dot{y} = -x_2 - x_3^3 - u$ . The change of variables  $T(x) = \begin{bmatrix} x_1 \\ x_2 + x_3 \\ x_2 \end{bmatrix}$

transforms the system into the globally defined normal form

$$\dot{\eta}_1 = -\eta_1 + y^3, \quad \dot{\eta}_2 = -\eta_2 + \eta_1^2 - (\eta_2 - y)^3, \quad \dot{y} = -y - (\eta_2 - y)^3 - u$$

It can be verified  $V(\eta) = \frac{1}{4}\eta_1^4 + \frac{1}{2}\eta_2^2$  satisfies the inequalities stated in the statement of the exercise. The functions  $a$  and  $b$  are given by  $a = 1$  and  $b = -y + (\eta_2 - y)^3$ . We take  $\hat{a} = 1$  and  $\hat{b} = -y - y^3$ . The control can be taken as

$$u = - \left[ y - y^3 - (\varrho + \beta_0) \operatorname{sat}\left(\frac{y}{\varepsilon}\right) \right]$$

- 14.48 (a) Let  $A$ ,  $B$ , and  $K$  be diagonal matrices whose diagonal elements are  $a_i$ ,  $b_i$ , and  $k_i$ , respectively. The closed-loop system is given by

$$\dot{x} = f(x, -Kz), \quad \dot{z} = -Az + b\dot{y}, \quad y = h(x)$$

The derivative of  $W = V + \frac{1}{2}z^TKB^{-1}z$  is given by

$$\dot{W} = \dot{V} + z^TKB^{-1}\dot{z} \leq -z^TK\dot{y} - z^TKB^{-1}Az + z^TK\dot{y} = -z^TKB^{-1}Az \leq 0$$

$$z(t) \equiv 0 \Rightarrow \dot{y}(t) \equiv 0 \Rightarrow x(t) \equiv 0$$

## 《非线性系统（第三版）》习题解答

due to zero-state observability. By the invariance principle, the origin is globally asymptotically stable.  
 (b) Repeat the analysis of part (a). For global asymptotic stability you need

$$\int_0^{z_i} \phi_i(\sigma) d\sigma \rightarrow \infty \text{ as } |z_i| \rightarrow \infty$$

so that the Lyapunov function will be radially unbounded.

(c) Take  $u = mg \sin \theta - k_p e + v$ , where  $e = \theta - \delta_1$  and  $k_p > 0$ .

$$m\ddot{e} + k_p e = v$$

The conditions are satisfied with  $V = \frac{1}{2}m\dot{e}^2 + \frac{1}{2}k_p e^2$ . The control is given by  $v = -kz$  where

$$\frac{z(s)}{e(s)} = \frac{bs}{s+a}$$

• 14.49 It follows from Lemma 4.7

• 14.50

• 14.51 (a)

$$J\dot{\omega} = k_t(\lambda_a i_b - \lambda_b i_a) - T_L = k_t \lambda_d (i_b \cos \rho - i_a \sin \rho) - T_L = k_t \lambda_d i_q - T_L$$

$$\begin{aligned} \lambda_d \dot{\lambda}_d &= \lambda_a \dot{\lambda}_a + \lambda_b \dot{\lambda}_b = -\frac{R_r}{L_r} \lambda_d^2 + \frac{R_r}{L_r} M(i_a \lambda_a + i_b \lambda_b) \\ &= -\frac{R_r}{L_r} \lambda_d^2 + \frac{R_r}{L_r} M \lambda_d (i_a \cos \rho + i_b \sin \rho) = -\frac{R_r}{L_r} \lambda_d^2 + \frac{R_r}{L_r} M \lambda_d i_d \end{aligned}$$

Assuming  $\lambda_d > 0$ , we can divide through by  $\lambda_d$ , to obtain

$$\dot{\lambda}_d = -\frac{R_r}{L_r} \lambda_d + \frac{R_r}{L_r} M i_d$$

$$\begin{aligned} \dot{\rho} &= \frac{\lambda_a \dot{\lambda}_b - \lambda_b \dot{\lambda}_a}{\lambda_a^2 + \lambda_b^2} \\ &= \frac{1}{\lambda_d^2} \left( -\frac{R_r}{L_r} \lambda_a \lambda_b + p\omega \lambda_a^2 + \frac{R_r M}{L_r} \lambda_a i_b + \frac{R_r}{L_r} \lambda_a \lambda_b + p\omega \lambda_b^2 - \frac{R_r M}{L_r} \lambda_b i_a \right) \\ &= p\omega + \frac{R_r M i_q}{L_r \lambda_d} \end{aligned}$$

(b) For constant  $\omega$ ,  $i_q$ , and  $\lambda_d$ ,  $\dot{\rho}$  is constant. Whenever  $\dot{\rho} \neq 0$ ,  $\rho$  will grow unbounded. However, the transformation depends only on  $\sin \rho$  and  $\cos \rho$ , which are always bounded.

(c) Flux regulation: the closed-loop system is given by

$$\dot{\lambda}_d = -\frac{R_r}{L_r} \lambda_d + \frac{R_r M}{L_r} \left[ \frac{\lambda_r}{M} - k(\lambda_d - \lambda_r) \right] = -\left( k + \frac{R_r}{L_r} \right) (\lambda_d - \lambda_r) \quad (14.1)$$

Hence,  $\lambda_d$  approaches  $\lambda_r$  monotonically. The time constant can be controlled by choosing  $k$ .

(d) The closed-loop system is

$$\dot{\lambda}_d = -\frac{R_r}{L_r} \lambda_d + \frac{R_r M}{L_r} I_d \text{ sat} \left( \frac{\lambda_r/M - k(\lambda_d - \lambda_r)}{I_d} \right)$$

## 《非线性系统（第三版）》习题解答

At the initial time,  $\lambda_d - \lambda_r < 0$ . There are two possible cases:

$$\lambda_r/M - k(\lambda_d - \lambda_r) \geq I_d \quad \text{or} \quad \lambda_r/M - k(\lambda_d - \lambda_r) < I_d$$

In the first case,  $i_d = I_d$  and the closed-loop system reduces to

$$\dot{\lambda}_d = -\frac{R_r}{L_r} \lambda_d + \frac{R_r M}{L_r} I_d$$

$\lambda_d$  will exponentially approach  $M I_d$  with the time constant  $L_r/R_r$ . Consequently,  $\lambda_r/M - k(\lambda_d - \lambda_r)$  will exponentially approach  $\lambda_r/M - kM(I_d - \lambda_r/M) < \lambda_r/M < I_d$ . Therefore, there must be some finite time  $t_1$  such that at  $t = t_1$ ,  $\lambda_r/M - k(\lambda_d - \lambda_r) = I_d$  and the closed-loop system is described by (14.1) for  $t \geq t_1$ .  $\lambda_d$  will exponentially approach  $\lambda_r$  for  $t \geq t_1$  with the time constant  $L_r/(R_r + kL_r)$  which is smaller than the time constant  $L_r/L_r$ . Therefore, the overall settling time is less than  $4L_r/R_r$ .

If, on the other hand,  $\lambda_r/M - k[\lambda_d(0) - \lambda_r] < I_d$ , the closed-loop system will be represented by (14.1) for all  $t \geq 0$  and the settling time will be  $4L_r/(R_r + kL_r)$ . With the choice  $k = 0$ , the second case will apply and the settling time will be  $4L_r/R_r$ .

(e) **Speed regulation:** assume  $\lambda_d = \lambda_r$  and consider the equation

$$J\dot{\omega} = k_t \lambda_r i_q - T_L \stackrel{\text{def}}{=} J\mu i_q - T_L$$

where  $\mu = k_t \lambda_r / J$ . Let  $e = \omega - \omega_r$ .

$$\dot{e} = \dot{\omega} - \dot{\omega}_r = \mu i_q - T_o/J - \phi(\omega)/J - \dot{\omega}_r$$

Assume

$$\left| \frac{T_o/J + \phi(\omega)/J + \dot{\omega}_r}{\mu} \right| \leq I_q - b, \quad b > 0$$

over the set  $\{|e| \leq c\}$ . Take  $i_q = -I_q \text{sat}(e/\varepsilon)$ . Then

$$\begin{aligned} e\dot{e} &= e \left[ -\mu I_q \text{sat}\left(\frac{e}{\varepsilon}\right) - T_o/J - \phi(\omega)/J - \dot{\omega}_r \right] \\ &\leq \mu \left[ -I_q e \text{sat}\left(\frac{e}{\varepsilon}\right) + (I_q - b)|e| \right] \end{aligned}$$

For  $|e| \geq \varepsilon$ ,

$$e\dot{e} \leq -\mu b |e|$$

Hence, for all  $|e(0)| \leq c$ ,  $e(t)$  reaches the set  $\{|e| \leq \varepsilon\}$  in finite time.

(f) Let  $\dot{e}_0 = e$  and  $z = k_0 e_0 + e$ . Then

$$\dot{z} = k_0 e + \mu i_q - T_o/J - \phi(\omega)/J - \dot{\omega}_r$$

Assume

$$\left| \frac{k_0 e - T_o/J - \phi(\omega)/J - \dot{\omega}_r}{\mu} \right| \leq I_q - b, \quad b > 0$$

over the set  $\Omega = \{|e_0| \leq c/k_0, |z| \leq c\}$ . Take  $i_q = -I_q \text{sat}(e/\varepsilon)$ . Then, for all  $(e_0, e) \in \Omega$  and  $|z| \geq \varepsilon$ , we have

$$z\dot{z} = z \left[ -\mu I_q \text{sat}\left(\frac{e}{\varepsilon}\right) + k_0 e - T_o/J - \phi(\omega)/J - \dot{\omega}_r \right] \leq -\mu b |z|$$

which shows that all trajectories starting  $\Omega$  reach  $\Omega_\varepsilon = \{|e_0| \leq \varepsilon/(k_0\theta_1), |z| \leq \varepsilon\}$  in finite time, where  $0 < \theta_1 < 1$ . Inside  $\Omega_\varepsilon$  we want to show that the trajectories asymptotically approach an equilibrium point where  $e = 0$ . The equilibrium point will correspond to the steady-state condition  $\omega = \bar{\omega}$ ,  $\dot{\omega} = 0$  and  $T_o = \text{constant}$ . The equilibrium equations are

$$0 = \bar{e}, \quad 0 = -\mu I_q \bar{z}/\varepsilon - \phi(\bar{\omega}_r)/J - T_o/J$$



## 《非线性系统（第三版）》习题解答

Hence, at equilibrium,  $\bar{e} = 0$  and  $\bar{z} = k_0 \bar{e}_0 = -(\varepsilon/\mu I_q) [\phi(\bar{\omega}) - T_0]$ . Let

$$\bar{e}_0 = e_0 - \bar{e}, \quad \bar{z} = z - \bar{z}$$

The new state variables  $(\bar{e}_0, \bar{z})$  satisfy the equations

$$\dot{\bar{e}}_0 = -k_0 \bar{e}_0 + \bar{z}, \quad \dot{\bar{z}} = k_0 (\bar{z} - k_0 \bar{e}_0) - (\mu I_q / \varepsilon) \bar{z} + \psi(e, t) + \nu(t)$$

where  $\psi = [\phi(\omega) - \phi(\omega_r)]/J$  and  $\nu = -[\phi(\omega_r) - \phi(\bar{\omega}_r)]/J - \dot{\omega}_r$ . Assuming that  $\phi$  is Lipschitz with a Lipschitz constant  $\ell$ , it can be seen that  $|\psi| \leq (\ell/J)|e| = (\ell/J)|\bar{z} - k_0 \bar{e}_0|$  and  $\lim_{t \rightarrow \infty} \nu(t) = 0$ . Using  $\bar{V} = (1/2)(\bar{e}_0^2 + \bar{z}^2)$  as a Lyapunov function candidate, we have

$$\begin{aligned} \dot{\bar{V}} &= -k_0 \bar{e}_0^2 + \bar{e}_0 \bar{z} + k_0 \bar{z}^2 - k_0^2 \bar{z} \bar{e}_0 - (\mu I_q / \varepsilon) \bar{z}^2 + \bar{z} \psi + \bar{z} \nu \\ &\leq -k_0 \bar{e}_0^2 + |\bar{e}_0| |\bar{z}| + k_0 \bar{z}^2 + k_0^2 |\bar{z}| |\bar{e}_0| - (\mu I_q / \varepsilon) \bar{z}^2 + (\ell/J) |\bar{z}|^2 + (k_0 \ell / J) |\bar{z}| |\bar{e}_0| + \bar{z} \nu \\ &= - \begin{bmatrix} |\bar{e}_0| \\ |\bar{z}| \end{bmatrix}^T \begin{bmatrix} k_0 & -0.5(1 + k_0^2 + k_0 \ell / J) \\ -0.5(1 + k_0^2 + k_0 \ell / J) & (\mu I_q / \varepsilon) - k_0 - \ell / J \end{bmatrix} \begin{bmatrix} |\bar{e}_0| \\ |\bar{z}| \end{bmatrix} + \bar{z} \nu \end{aligned}$$

Choose  $\varepsilon$  small enough that the  $2 \times 2$  matrix is positive definite; that is,

$$k_0 [(\mu I_q / \varepsilon) - k_0 - \ell / J] - 0.25(1 + k_0^2 + k_0 \ell / J)^2 > 0$$

Then, it can be shown that  $(\bar{e}_0(t), \bar{z}(t))$  tend to zero at  $t$  tends to  $\infty$ .

(g)

$$\begin{aligned} J\dot{\omega} &= k_t(\lambda_a i_b - \lambda_b i_a) - T_L = k_t[\hat{\lambda}_a i_b - \hat{\lambda}_b i_a + (\lambda_a - \hat{\lambda}_a) i_b - (\lambda_b - \hat{\lambda}_b) i_a] - T_L \\ &= k_t \lambda_d (i_b \cos \rho - i_a \sin \rho) \\ &\quad + k_t [(\hat{\lambda}_b - \lambda_b) i_b - (\hat{\lambda}_a - \lambda_a) i_a] \begin{bmatrix} \cos \rho & -\sin \rho \\ \sin \rho & \cos \rho \end{bmatrix} \begin{bmatrix} i_d \\ i_q \end{bmatrix} - T_L \\ &= k_t \lambda_d i_q + k_t (e_q i_d - e_d i_q) - T_L \end{aligned}$$

$$\begin{aligned} \lambda_d \dot{\lambda}_d &= \hat{\lambda}_a \dot{\lambda}_a + \hat{\lambda}_b \dot{\lambda}_b = -\frac{\hat{R}_r}{L_r} \lambda_d^2 + \frac{\hat{R}_r}{L_r} M (i_a \hat{\lambda}_a + i_b \hat{\lambda}_b) \\ &= -\frac{\hat{R}_r}{L_r} \lambda_d^2 + \frac{R_r}{L_r} M \lambda_d (i_a \cos \rho + i_b \sin \rho) = -\frac{\hat{R}_r}{L_r} \lambda_d^2 + \frac{R_r}{L_r} M \lambda_d i_d \end{aligned}$$

Assuming  $\lambda_d > 0$ , we can divide through by  $\lambda_d$ , to obtain

$$\dot{\lambda}_d = -\frac{\hat{R}_r}{L_r} \lambda_d + \frac{\hat{R}_r}{L_r} M i_d$$

$$\begin{aligned} \dot{\rho} &= \frac{\hat{\lambda}_a \dot{\lambda}_b - \hat{\lambda}_b \dot{\lambda}_a}{\hat{\lambda}_a^2 + \hat{\lambda}_b^2} \\ &= \frac{1}{\lambda_d^2} \left( -\frac{\hat{R}_r}{L_r} \hat{\lambda}_a \hat{\lambda}_b + p\omega \hat{\lambda}_a^2 + \frac{\hat{R}_r M}{L_r} \hat{\lambda}_a i_b + \frac{\hat{R}_r}{L_r} \hat{\lambda}_a \hat{\lambda}_b + p\omega \hat{\lambda}_b^2 - \frac{\hat{R}_r M}{L_r} \hat{\lambda}_b i_a \right) \\ &= p\omega + \frac{\hat{R}_r M i_q}{L_r \lambda_d} \end{aligned}$$

## 《非线性系统（第三版）》习题解答

$$\begin{aligned}
 \dot{e}_d &= [-(\hat{\lambda}_a - \lambda_a) \sin \rho + (\hat{\lambda}_b - \lambda_b) \cos \rho] \dot{\rho} + (\hat{\lambda}_a - \lambda_a) \cos \rho + (\hat{\lambda}_b - \lambda_b) \sin \rho \\
 &= e_q \dot{\rho} + \left[ -\frac{R_r}{L_r} (\hat{\lambda}_a - \lambda_a) - p\omega (\hat{\lambda}_b - \lambda_b) - \frac{(\hat{R}_r - R_r)}{L_r} \hat{\lambda}_a + \frac{(\hat{R}_r - R_r)}{L_r} M i_a \right] \cos \rho \\
 &\quad + \left[ -\frac{R_r}{L_r} (\hat{\lambda}_b - \lambda_b) + p\omega (\hat{\lambda}_a - \lambda_a) - \frac{(\hat{R}_r - R_r)}{L_r} \hat{\lambda}_b + \frac{(\hat{R}_r - R_r)}{L_r} M i_b \right] \sin \rho \\
 &= e_q \dot{\rho} - \frac{R_r}{L_r} e_d - p\omega e_q - \frac{(\hat{R}_r - R_r)}{L_r} \lambda_d + \frac{(\hat{R}_r - R_r)}{L_r} M i_d \\
 &= -\frac{R_r}{L_r} e_d + \frac{\hat{R}_r M i_q}{L_r \lambda_d} e_q + \frac{(\hat{R}_r - R_r)}{L_r} (M i_d - \lambda_d)
 \end{aligned}$$

$$\begin{aligned}
 \dot{e}_q &= [-(\hat{\lambda}_a - \lambda_a) \cos \rho - (\hat{\lambda}_b - \lambda_b) \sin \rho] \dot{\rho} - (\hat{\lambda}_a - \lambda_a) \sin \rho + (\hat{\lambda}_b - \lambda_b) \cos \rho \\
 &= -e_d \dot{\rho} - \left[ -\frac{R_r}{L_r} (\hat{\lambda}_a - \lambda_a) - p\omega (\hat{\lambda}_b - \lambda_b) - \frac{(\hat{R}_r - R_r)}{L_r} \hat{\lambda}_a + \frac{(\hat{R}_r - R_r)}{L_r} M i_a \right] \sin \rho \\
 &\quad + \left[ -\frac{R_r}{L_r} (\hat{\lambda}_b - \lambda_b) + p\omega (\hat{\lambda}_a - \lambda_a) - \frac{(\hat{R}_r - R_r)}{L_r} \hat{\lambda}_b + \frac{(\hat{R}_r - R_r)}{L_r} M i_b \right] \cos \rho \\
 &= -e_d \dot{\rho} - \frac{R_r}{L_r} e_q + p\omega e_d + \frac{(\hat{R}_r - R_r)}{L_r} M i_q \\
 &= -\frac{R_r}{L_r} e_q - \frac{\hat{R}_r M i_q}{L_r \lambda_d} e_d + \frac{(\hat{R}_r - R_r)}{L_r} M i_q
 \end{aligned}$$

(h) Repeat parts 3 and 4.

(i) With  $V = (1/2)(e_d^2 + e_q^2)$ , we have

$$\begin{aligned}
 \dot{V} &= e_d \dot{e}_d + e_q \dot{e}_q = -\frac{R_r}{L_r} (e_d^2 + e_q^2) + \frac{(\hat{R}_r - R_r)}{L_r} M e_q i_q \\
 &\leq -\frac{R_r(1-\alpha)}{L_r} \|e\|^2 - \frac{R_r\alpha}{L_r} \|e\|^2 + \left| \frac{(\hat{R}_r - R_r)}{L_r} \right| M \|e\| I_q \\
 &\leq -\frac{R_r(1-\alpha)}{L_r} \|e\|^2, \quad \forall \|e\| \geq \left| \frac{(\hat{R}_r - R_r)}{\alpha R_r} \right| M I_q
 \end{aligned}$$

where  $0 < \alpha < 1$ . Using Theorem 4.18, it can be shown that

$$\begin{aligned}
 \|e(t)\| &\leq \exp \left[ -\frac{R_r(1-\alpha)}{L_r} t \right] \|e(0)\| + \left| \frac{(\hat{R}_r - R_r)}{\alpha R_r} \right| M I_q \\
 &= \lambda_r \left[ \exp(-\gamma t) \left( \frac{\|e(0)\|}{\lambda_r} \right) + \left| \frac{(\hat{R}_r - R_r)}{R_r} \right| \frac{M I_q}{\alpha \lambda_r} \right]
 \end{aligned}$$

where  $\gamma = (1-\alpha)R_r/L_r$ .

(j)

$$\dot{z} = k_0 e + \frac{2pM}{3LJ} [(\lambda_r - e_d) i_q + e_q \lambda_r / M] - T_L / J - \dot{\omega}_r$$

Restrict analysis to a region where  $\lambda_r - e_d > 0$ .

$$z \dot{z} \leq \frac{2pM}{3LJ} (\lambda_r - e_d) \left[ -z I_q \operatorname{sat} \left( \frac{z}{\varepsilon} \right) + |z| \frac{|e_q \lambda_r / M + (3LJ/2pM)(k_0 e - T_L / J - \dot{\omega}_r)|}{(\lambda_r - e_d)} \right]$$

## 《非线性系统（第三版）》习题解答

The controller will work if

$$\frac{|e_q \lambda_r / M + (3LJ/2pM)(k_0 e - T_L/J - \dot{\omega}_r)|}{(\lambda_r - e_d)} \leq I_q - b$$

• 14.52 (a)

$$\begin{aligned} \dot{s} &= \Lambda \dot{e} + \ddot{e} = \Lambda \dot{e} + \ddot{q} - \ddot{q}_r \\ &= \Lambda \dot{e} + M^{-1}(-C\dot{q} - D\dot{q} - g + u) - \ddot{q}_r \\ &= \Lambda \dot{e} + M^{-1}[-C\dot{q} - D\dot{q} - g + \hat{M}v + L(\hat{C}\dot{q} + \hat{g} + \hat{M}\ddot{q}_r - \hat{M}\Lambda \dot{e})] - \ddot{q}_r \\ &= v + \Delta \end{aligned}$$

where

$$\Delta = (M^{-1}\hat{M} - I)v + \Lambda \dot{e} + M^{-1}[-C\dot{q} - D\dot{q} - g + L(\hat{C}\dot{q} + \hat{g} + \hat{M}\ddot{q}_r - \hat{M}\Lambda \dot{e})] - \ddot{q}_r$$

When  $L = 0$ ,

$$\Delta = (M^{-1}\hat{M} - I)v + \Lambda \dot{e} + M^{-1}[-C\dot{q} - D\dot{q} - g] - \ddot{q}_r$$

When  $L = I$ ,

$$\begin{aligned} \Delta &= (M^{-1}\hat{M} - I)v + \Lambda \dot{e} + M^{-1}[-C\dot{q} - D\dot{q} - g + (\hat{C}\dot{q} + \hat{g} + \hat{M}\ddot{q}_r - \hat{M}\Lambda \dot{e})] - \ddot{q}_r \\ &= (M^{-1}\hat{M} - I)(v - \Lambda \dot{e} + \ddot{q}_r) + M^{-1}[(\hat{C} - C)\dot{q} - D\dot{q} + \hat{g} - g] \end{aligned}$$

(b) Write  $\Delta$  as  $\Delta = (M^{-1}\hat{M} - I)v + \delta$ , where  $\delta$  is independent of  $v$ . Let  $\rho$  be an upper bound on  $\|\delta\|_\infty$ .

$$|\Delta_i| \leq \left| \left( (M^{-1}\hat{M} - I)v \right)_i \right| + \|\delta\|_\infty \leq \kappa_0 \|v\|_\infty + \rho$$

(c)

$$s_i \dot{s}_i = s_i(v_i + \Delta_i) = -\beta s_i \text{sat}\left(\frac{s_i}{\varepsilon}\right) + s_i \Delta_i$$

For  $|s_i| \geq \varepsilon$ ,

$$s_i \dot{s}_i \leq -\beta |s_i| + |s_i|(\rho + \kappa_0 \|v\|_\infty) \leq -(1 - \kappa_0)\beta |s_i| + \rho |s_i|$$

Choose

$$\beta \geq \frac{\rho}{1 - \kappa_0} + \beta_0, \quad \beta_0 > 0$$

$$s_i \dot{s}_i \leq -(1 - \kappa_0)\beta |s_i| + (1 - \kappa_0)(\beta - \beta_0) |s_i| \leq -(1 - \kappa_0)\beta_0 |s_i|$$

Hence,  $s_i$  reaches the boundary layer  $\{|s_i| \leq \varepsilon\}$  in finite time. Inside the boundary layer, we have  $\dot{e} = -\Lambda e + s$ . Since  $\Lambda$  is diagonal ( $\Lambda = \text{diag}(\lambda_1, \dots, \lambda_m)$ ),

$$\dot{e}_i = -\lambda_i e_i + s_i$$

$$e_i \dot{e}_i \leq -\lambda_i e_i^2 + \varepsilon |e_i| \leq -(1 - \theta)\lambda_i e_i^2, \quad \forall |e_i| \geq \varepsilon/(\theta\lambda_i)$$

where  $0 < \theta < 1$ . Hence,  $e_i$  reaches the set  $\{|e_i| \leq \varepsilon/(\theta\lambda_i)\}$  in finite time. The ultimate bound on  $e$  can be estimated by  $(\varepsilon/\theta)\sqrt{\sum_{i=1}^m (1/\lambda_i)^2}$  since

$$\|e\|_2 = \sqrt{\sum_{i=1}^m e_i^2} \leq \sqrt{\sum_{i=1}^m \left(\frac{\varepsilon}{\theta\lambda_i}\right)^2} = \frac{\varepsilon}{\theta} \sqrt{\sum_{i=1}^m \left(\frac{1}{\lambda_i}\right)^2}$$

(d) We recover the previous result with a finite region of attraction because the analysis has to be limited to a set where the inequality  $\beta \geq \beta_0 + \rho/(1 - \kappa_0)$  is satisfied.

## 《非线性系统（第三版）》习题解答

• 14.53 (a)

$$\dot{s} = \Lambda \dot{e} + M^{-1}(-C\dot{q} - D\dot{q} - g + u) - \ddot{q}_r$$

$$\begin{aligned} \dot{W} &= s^T M \dot{s} + \frac{1}{2} s^T \dot{M} s \\ &= s^T M \Lambda \dot{e} + s^T [-C(s - \Lambda e + \dot{q}_r) - D\dot{q} - g + u] - s^T M \ddot{q}_r + \frac{1}{2} s^T \dot{M} s \\ &= +\frac{1}{2} s^T (\dot{M} - 2C) s + s^T [M \Lambda \dot{e} + C(\Lambda e - \dot{q}_r) - D\dot{q} - g + u - M \ddot{q}_r] \\ &= s^T [M \Lambda \dot{e} + C(\Lambda e - \dot{q}_r) - D\dot{q} - g - M \ddot{q}_r + u] \end{aligned}$$

(b)

$$\begin{aligned} \dot{W} &= s^T [M \Lambda \dot{e} + C(\Lambda e - \dot{q}_r) - D\dot{q} - g - M \ddot{q}_r + v + L(-\hat{M} \Lambda \dot{e} - \hat{C}(\Lambda e - \dot{q}_r) - \hat{g} + \hat{M} \ddot{q}_r)] \\ &= s^T (v + \Delta) \end{aligned}$$

where

$$\Delta = M \Lambda \dot{e} + C(\Lambda e - \dot{q}_r) - D\dot{q} - g - M \ddot{q}_r + L(-\hat{M} \Lambda \dot{e} - \hat{C}(\Lambda e - \dot{q}_r) - \hat{g} + \hat{M} \ddot{q}_r)$$

When  $L = 0$ ,

$$\Delta = M \Lambda \dot{e} + C(\Lambda e - \dot{q}_r) - D\dot{q} - g - M \ddot{q}_r$$

When  $L = I$ ,

$$\Delta = M \Lambda \dot{e} + C(\Lambda e - \dot{q}_r) - D\dot{q} - g - M \ddot{q}_r - \hat{M} \Lambda \dot{e} - \hat{C}(\Lambda e - \dot{q}_r) - \hat{g} + \hat{M} \ddot{q}_r$$

(c) For  $\|s\|_2 \geq \varepsilon$ ,  $\varphi(s/\varepsilon) = s/\|s\|_2$ , and for  $\|s\|_2 < \varepsilon$ ,  $\varphi(s/\varepsilon) = s/\varepsilon$ . Thus, for  $\|s\|_2 \geq \varepsilon$ , we have

$$\dot{W} = s^T \left( -\beta \frac{s}{\|s\|_2} + \Delta \right) \leq -\beta \|s\|_2 + \|s\|_2 \|\Delta\|_2$$

Choose  $\beta \geq \|\Delta\|_2 + \beta_0$ , with  $\beta_0 > 0$ , to obtain

$$\dot{W} \leq -\beta_0 \|s\|_2 \leq -\beta_0 \varepsilon, \quad \text{for } W \geq \lambda_M \varepsilon^2$$

This inequality shows that the trajectories reach the positively invariant set  $\{W \leq \lambda_M \varepsilon^2\}$  in finite time. Inside the set, we have  $\|s\|_2 \leq \varepsilon \sqrt{\lambda_M / \lambda_m}$ . Using the equation  $\dot{e} = -\Lambda e + s$  we can calculate an ultimate bound on  $e$ . In particular,

$$e^T \dot{e} = -e^T \Lambda e + e^T s \leq -k \|e\|_2^2 + \|e\|_2 \varepsilon \sqrt{\lambda_M / \lambda_m}$$

which shows that the ultimate bound on  $\|e\|_2$  is proportional to  $\varepsilon$ .

(d) We recover the previous result with a finite region of attraction because the analysis has to be limited to a set where the inequality  $\beta \geq \|\Delta\|_2 + \beta_0$  is satisfied.

• 14.54 Simulation results for the different control laws are given in Figures 14.2 to 14.5. The controller parameters are  $\Lambda = 10I$ ,  $\varepsilon = 0.05$ , and  $\beta = 30$ . The control saturation levels are  $U_1 = 6000$  and  $U_2 = 5000$ .

• 14.55 Simulation results for the different control laws are given in Figure 14.6. The controller parameters are  $K_p = K_d = 7000I$ . The control saturation levels are  $U_1 = 6000$  and  $U_2 = 5000$ .

• 14.56 The equation of motion is given by

$$D(\theta) \begin{bmatrix} \ddot{\theta} \\ \ddot{x}_c \end{bmatrix} = \begin{bmatrix} u \\ mL\dot{\theta}^2 \sin \theta - kx_c \end{bmatrix}, \quad \text{where } D(\theta) = \begin{bmatrix} I + mL^2 & mL \cos \theta \\ mL \cos \theta & m + M \end{bmatrix}$$

《非线性系统（第三版）》习题解答

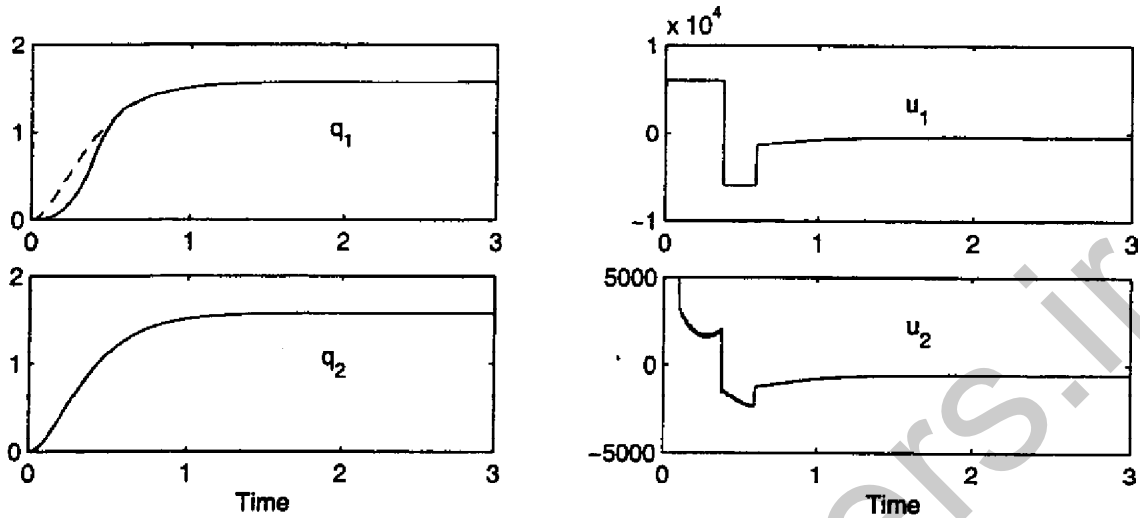

Figure 14.2: Exercise 14.54(1).

(a) Let

$$V = \frac{1}{2}v^T D(\theta)v + \frac{1}{2}kx_c^2, \quad \text{where } v = \begin{bmatrix} \dot{\theta} \\ \dot{x}_c \end{bmatrix}$$

$$\begin{aligned} \dot{V} &= v^T D(\theta)\dot{v} + \frac{1}{2}v^T \begin{bmatrix} 0 & -mL \sin \theta \\ -mL \sin \theta & 0 \end{bmatrix} v \dot{\theta} + kx_c \dot{x}_c \\ &= \begin{bmatrix} \dot{\theta} & \dot{x}_c \end{bmatrix} \begin{bmatrix} u \\ mL\dot{\theta}^2 \sin \theta - kx_c \end{bmatrix} + \frac{1}{2} \begin{bmatrix} \dot{\theta} & \dot{x}_c \end{bmatrix} \begin{bmatrix} -\dot{\theta}\dot{x}_c mL \sin \theta \\ -\dot{\theta}^2 mL \sin \theta \end{bmatrix} + kx_c \dot{x}_c \\ &= \dot{\theta}u \end{aligned}$$

Hence, the system is passive. Check zero-state observability with  $y = \dot{\theta}$ . When  $u = 0$ ,

$$y(t) \equiv 0 \Rightarrow \dot{\theta}(t) \equiv 0 \Rightarrow \ddot{\theta}(t) \equiv 0 \text{ and } \theta(t) \equiv \theta(\text{constant})$$

$$\dot{\theta}(t) \equiv 0 \text{ and } \ddot{\theta}(t) \equiv 0 \Rightarrow \ddot{x}_c(t) \cos \theta \equiv 0 \text{ and } (m + M)\ddot{x}_c = -kx_c(t)$$

$$\cos \theta \neq 0 \Rightarrow \ddot{x}_c(t) \equiv 0 \Rightarrow x_c(t) \equiv 0 \Rightarrow \dot{x}_c(t) \equiv 0$$

Thus,  $y(t) \equiv 0$  does not imply that  $\theta(t) \equiv 0$ . The system is not zero-state observable.

(b) Let  $u = -\phi_1(\theta) + w$ .

$$V = \frac{1}{2}v^T D(\theta)v + \frac{1}{2}kx_c^2 + \int_0^\theta \phi_1(\lambda) d\lambda$$

$$\dot{V} = \dot{\theta}[-\phi_1(\theta) + w] + \phi_1(\theta)\dot{\theta} = \dot{\theta}w$$

Hence, the system is passive. Check zero-state observability with  $y = \dot{\theta}$ . When  $w = 0$ ,

$$y(t) \equiv 0 \Rightarrow \dot{\theta}(t) \equiv 0 \Rightarrow \ddot{\theta}(t) \equiv 0 \text{ and } \theta(t) \equiv \theta(\text{constant})$$

$$\dot{\theta}(t) \equiv 0 \text{ and } \ddot{\theta}(t) \equiv 0 \Rightarrow mL\ddot{x}_c(t) \cos \theta = -\phi_1(\theta) \text{ and } (m + M)\ddot{x}_c = -kx_c(t)$$

$\cos \theta \neq 0$  implies that  $x_c(t)$  is identically zero. Then,

$$mL\ddot{x}_c \cos \theta = -\phi_1(\theta) \Rightarrow \phi_1(\theta) = 0 \Rightarrow \theta = 0$$

## 《非线性系统（第三版）》习题解答

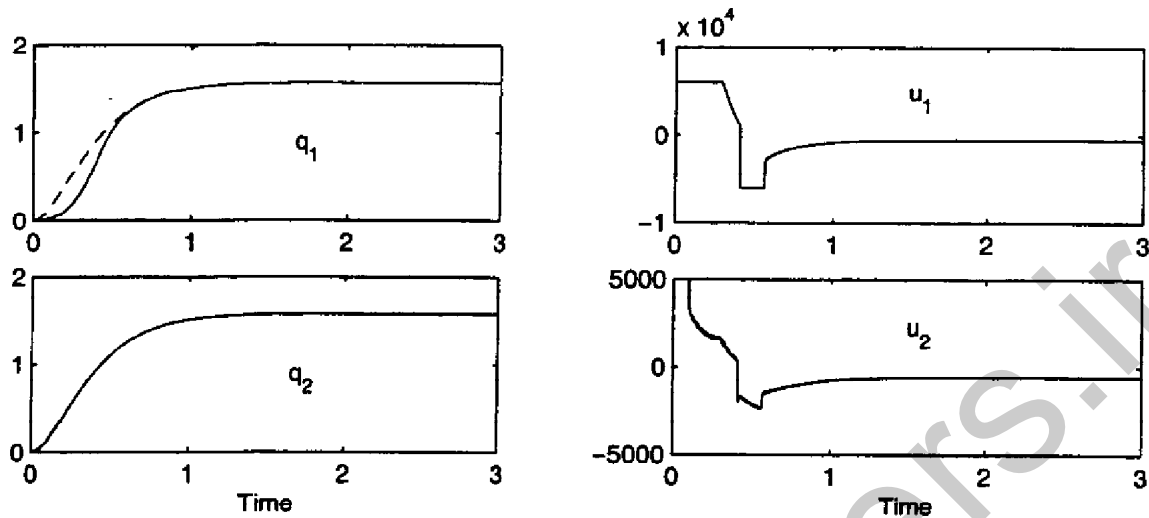

Figure 14.3: Exercise 14.54(2).

Hence, the system is zero-state observable.

(c) Since the system from  $w$  to  $\dot{\theta}$  is passive (with a radially unbounded storage function) and zero-state observable, it can be globally stabilized by  $w = -\phi_2(\dot{\theta})$ . The overall control is  $u = -\phi_1(\theta) - \phi_2(\dot{\theta})$ .

(e) Simulation results are shown in Figure 14.7 for  $U_p = U_v = 0.05$  and  $K_p = K_v = 0.1$ . The settling time is about 30 sec.

(f) Simulation results are shown in Figure 14.8 for  $U_p = U_v = 0.05$ ,  $K_p = K_v = 0.1$ , and two different values of  $\varepsilon$ : 0.5 and 0.1. As we reduce  $\varepsilon$ , we recover the performance under state feedback.

• 14.57 The equation of motion is given by

$$D(\theta) \begin{bmatrix} \ddot{\theta} \\ \ddot{x}_c \end{bmatrix} = \begin{bmatrix} u \\ mL\dot{\theta}^2 \sin \theta - kx_c \end{bmatrix}, \quad \text{where } D(\theta) = \begin{bmatrix} I + mL^2 & mL \cos \theta \\ mL \cos \theta & m + M \end{bmatrix}.$$

$$\Delta(\theta) = \det(D(\theta)).$$

(a)

$$\begin{aligned} \eta_1 &= \dot{x}_c + \frac{mL\dot{\theta}}{m+M} \cos \theta = \eta_2 \\ \eta_2 &= \ddot{x}_c + \frac{mL\ddot{\theta}}{m+M} \cos \theta - \frac{mL\dot{\theta}^2}{m+M} \sin \theta \\ &= \begin{bmatrix} \frac{mL}{m+M} \cos \theta & 1 \end{bmatrix} \frac{1}{\Delta(\theta)} \begin{bmatrix} m+M & -mL \cos \theta \\ -mL \cos \theta & I + mL^2 \end{bmatrix} \begin{bmatrix} u \\ mL\dot{\theta}^2 \sin \theta - kx_c \end{bmatrix} - \frac{mL\dot{\theta}^2}{m+M} \sin \theta \\ &= \frac{1}{m+M} [mL\dot{\theta}^2 \sin \theta - kx_c] - \frac{mL\dot{\theta}^2}{m+M} \sin \theta \\ &= -\frac{k}{m+M} x_c = -\frac{k}{m+M} \left( \eta_1 - \frac{mL}{m+M} \sin \eta_3 \right) \\ \eta_3 &= \dot{\theta} = \xi \\ \dot{\xi} &= \ddot{\theta} = \frac{1}{\Delta(\theta)} [(m+M)u - mL \cos \theta (mL\dot{\theta}^2 \sin \theta - kx_c)] \end{aligned}$$

The transformed system takes the regular form (14.4)–(14.5).

## 《非线性系统（第三版）》习题解答

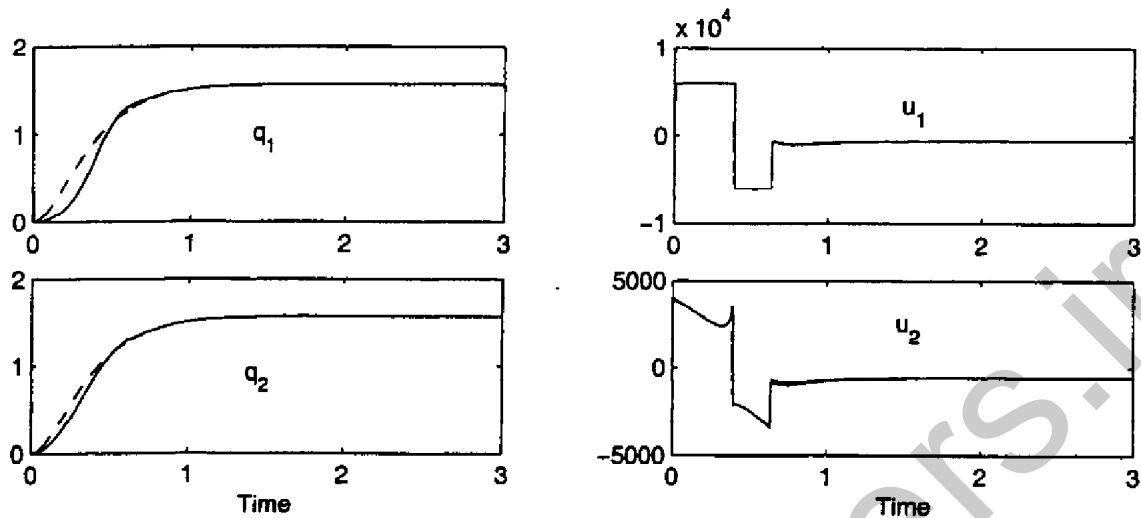

Figure 14.4: Exercise 14.54(3).

(b) Consider the system

$$\dot{\eta}_1 = \dot{\eta}_2, \quad \dot{\eta}_2 = -\frac{k}{m+M} \left( \eta_1 - \frac{mL}{m+M} \sin \eta_3 \right), \quad \dot{\eta}_3 = \phi(\eta) = k_1 \left( \eta_1 - \frac{mL}{m+M} \sin \eta_3 \right) \cos \eta_3 - k_2 \eta_3$$

with the Lyapunov function  $V_0(\eta)$ .

$$\dot{V}_0 = - \left[ k_2 \eta_3 - k_1 \left( \eta_1 - \frac{mL}{m+M} \sin \eta_3 \right) \cos \eta_3 \right]^2 = -\phi^2(\eta) \leq 0$$

$$\dot{V}_0 \equiv 0 \Rightarrow \phi(\eta(t)) \equiv 0 \Rightarrow \dot{\eta}_3(t) \equiv 0 \Rightarrow \eta_3(t) \equiv \eta_3(\text{constant})$$

$$\cos \eta_3 \neq 0 \Rightarrow \eta_1(t) \equiv \eta_1(\text{constant}) \Rightarrow \dot{\eta}_1(t) \equiv 0 \Rightarrow \eta_2(t) \equiv 0$$

$$\eta_2(t) \equiv 0 \Rightarrow \dot{\eta}_2(t) \equiv 0 \Rightarrow \eta_1 - \frac{mL}{m+M} \sin \eta_3 = 0 \Rightarrow \eta_3 = 0 \Rightarrow \eta_1 = 0$$

By the invariance principle, the origin  $\eta = 0$  is globally asymptotically stable. Thus, the sliding surface can be taken as  $s = 0$ , where

$$s = \xi - \phi(\eta) = \xi - k_1 \left( \eta_1 - \frac{mL}{m+M} \sin \eta_3 \right) \cos \eta_3 + k_2 \eta_3 = \dot{\theta} + k_2 \theta - k_1 x_c \cos \theta$$

(c)

$$\begin{aligned} \dot{s} &= \ddot{\theta} + k_2 \dot{\theta} - k_1 \dot{x}_c + k_1 x_c \dot{\theta} \sin \theta \\ &= \frac{1}{\Delta(\theta)} \left\{ (m+M)u - mL \cos \theta (mL \dot{\theta}^2 \sin \theta - k x_c) \right\} + k_2 \dot{\theta} - k_1 \dot{x}_c \cos \theta + k_1 x_c \dot{\theta} \sin \theta \\ &= \frac{m+M}{\Delta(\theta)} \left\{ u + \frac{1}{m+M} \left[ -mL \cos \theta (mL \dot{\theta}^2 \sin \theta - k x_c) + \Delta(\theta) (k_2 \dot{\theta} - k_1 \dot{x}_c \cos \theta + k_1 x_c \dot{\theta} \sin \theta) \right] \right\} \end{aligned}$$

Choose  $\beta(x)$  to satisfy

$$\beta(x) \geq \beta_0 + \frac{1}{m+M} \left| -mL \cos \theta (mL \dot{\theta}^2 \sin \theta - k x_c) + \Delta(\theta) (k_2 \dot{\theta} - k_1 \dot{x}_c \cos \theta + k_1 x_c \dot{\theta} \sin \theta) \right|$$

## 《非线性系统（第三版）》习题解答

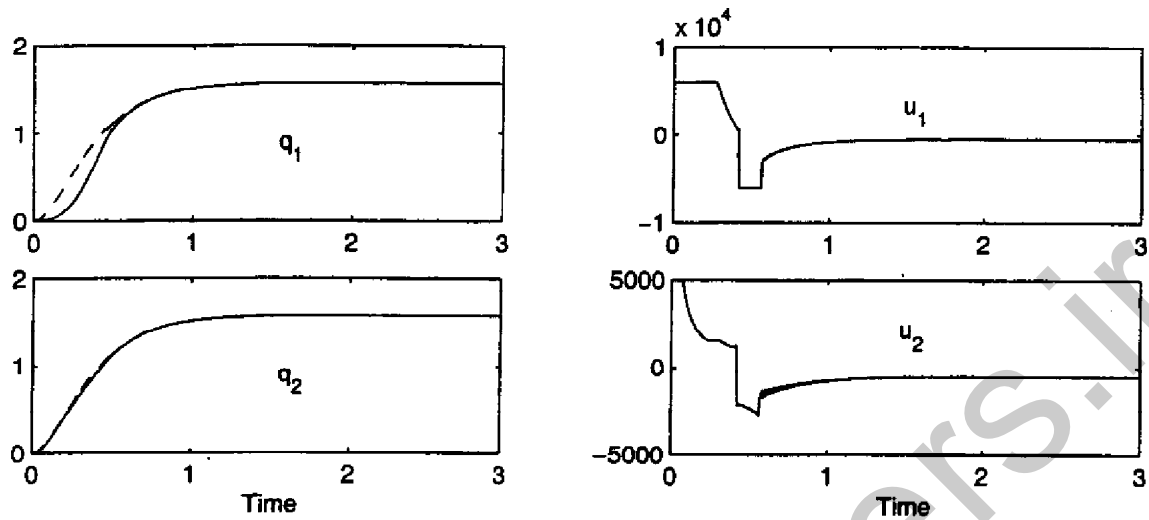

Figure 14.5: Exercise 14.54(4).

for some  $\beta_0 > 0$ . Then, the control law  $u = -\beta(x) \text{sat}(s/\mu)$  guarantees that

$$s\dot{s} \leq -\beta_0 \frac{m+M}{\Delta(\theta)} |s|, \quad \text{for } |s| \geq \mu$$

Hence, all trajectories reach the boundary layer  $\{|s| \leq \mu\}$  in finite time. Assuming that the system

$$\dot{\eta}_1 = \eta_2, \quad \dot{\eta}_2 = -\frac{k}{m+M} \left( \eta_1 - \frac{mL}{m+M} \sin \eta_3 \right), \quad \dot{\eta}_3 = \phi(\eta) + s$$

is input-to-state stable, we can show, as in the proof of Theorem 14.1, that all trajectories reach a set  $\Omega_\epsilon$  in the neighborhood of the origin. Local analysis will then show that for sufficiently small  $\mu$  the origin is locally exponentially stable. Hence, for sufficiently small  $\mu$ , all trajectories converge to the origin as  $t$  tends to infinity.

(d) Since

$$\left| -mL \cos \theta (mL\dot{\theta}^2 \sin \theta - kx_c) + \Delta(\theta)(k_2\dot{\theta} - k_1\dot{x}_c \cos \theta + k_1x_c\dot{\theta} \sin \theta) \right|$$

vanishes at the origin, for any  $\beta > \beta_0$ , the inequality

$$\beta \geq \beta_0 + \frac{1}{m+M} \left| -mL \cos \theta (mL\dot{\theta}^2 \sin \theta - kx_c) + \Delta(\theta)(k_2\dot{\theta} - k_1\dot{x}_c \cos \theta + k_1x_c\dot{\theta} \sin \theta) \right|$$

is satisfied in some neighborhood of the origin. Limit the analysis to such neighborhood.

(f) Simulation results are shown in Figure 14.9 for  $k_1 = 1000$ ,  $k_2 = 1$ ,  $\beta = 0.1$ , and  $\mu = 0.05$ . The settling time is about 4 sec.

(g) Simulation results are shown in Figure 14.10 for  $k_1 = 1000$ ,  $k_2 = 1$ ,  $\beta = 0.1$ ,  $\mu = 0.05$ , and  $\epsilon = 0.1$ . The response under output feedback is very close to the response under state feedback.



《非线性系统（第三版）》习题解答

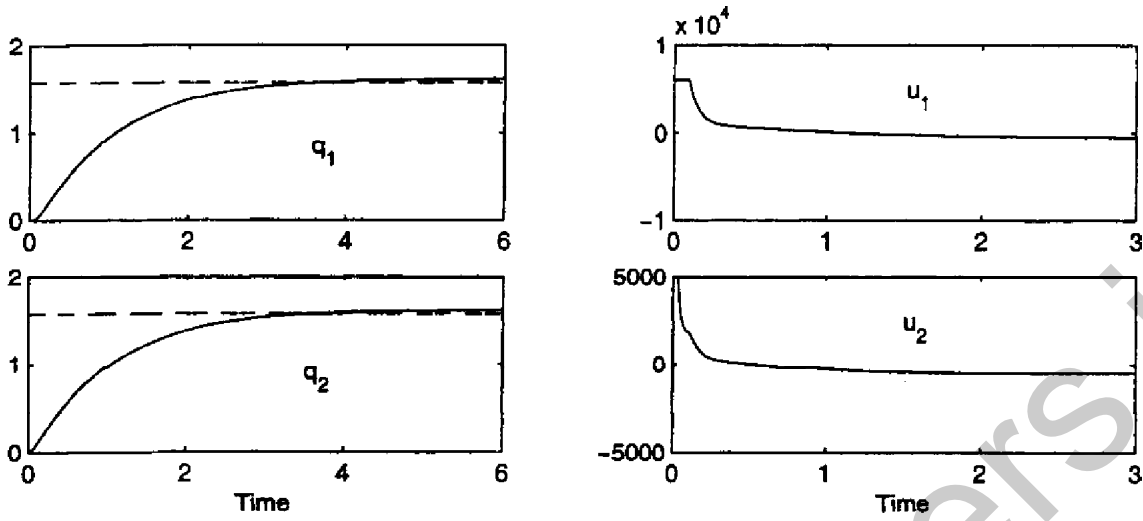

Figure 14.6: Exercise 14.55.

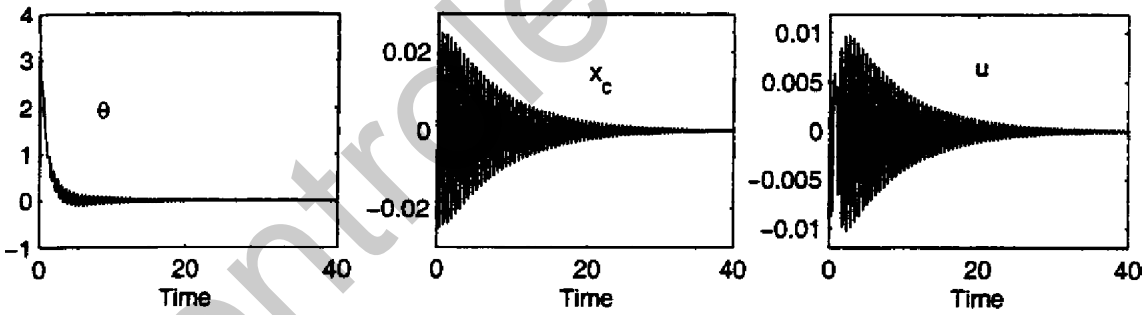

Figure 14.7: Exercise 14.56(e).

《非线性系统（第三版）》习题解答

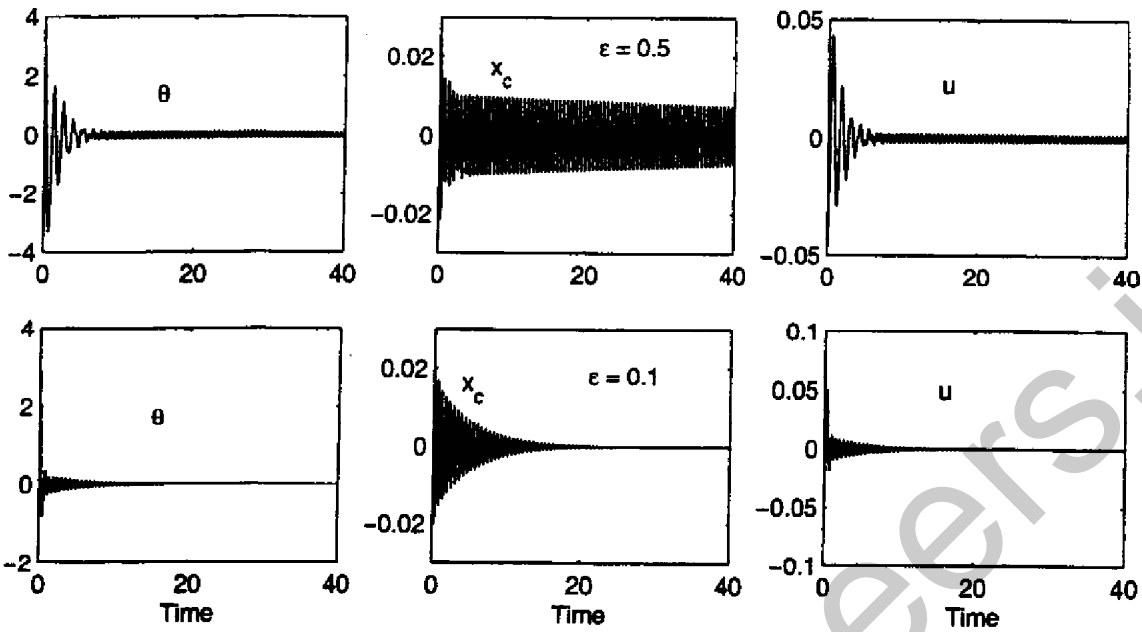

Figure 14.8: Exercise 14.56(f).

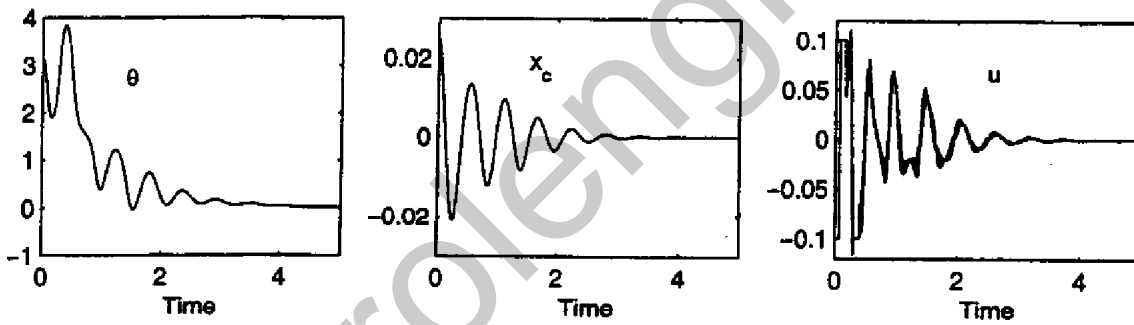

Figure 14.9: Exercise 14.57(f).

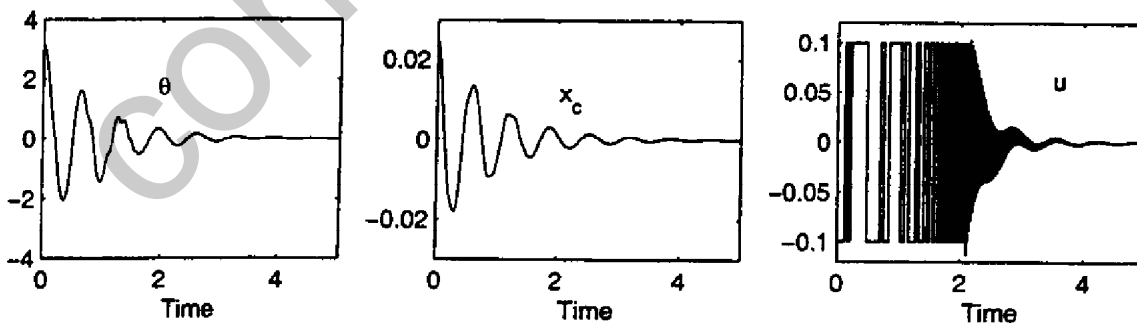

Figure 14.10: Exercise 14.57(g).