

# پلتفرم اختصاصی مهندسی کنترل



<https://controlengineers.ir>



<https://t.me/controlengineers>



<https://www.instagram.com/controlengineers.ir>

## SIMATIC HMI

## WinCC

Manual  
Volume 1 / 2

### Volume 1

Preface	1
System Overview	2
Authorization	3
WinCC Explorer	4
Channels	5
Report Designer	6
User Administrator	7

### Volume 2

Graphics Designer	8
Alarm Logging	9
Tag Logging	10
Text Library	11
Global Script	12
Cross Reference	13

This manual is part of the documentation package with the order number: 6AV6392-1XA05-0AB0

Edition August 1999

WinCC®, SIMATIC®, SIMATIC NET®, SINEC® and STEP® are Siemens registered trademarks.

All other product and system names in this manual are (registered) trademarks of their respective owners and must be treated accordingly.

(The reproduction, transmission or use of this document or its contents is not permitted without express written authority. Offenders will be liable for damages. All rights, including rights created by patent grant or registration of a utility model or design, are reserved.)

(We have checked the contents of this manual for agreement with the hardware and software described. Since deviations cannot be precluded entirely, we cannot guarantee full agreement. However, the data in this manual are reviewed regularly and any necessary corrections included in subsequent editions. Suggestions for improvement are welcomed.)

© Siemens AG 1994 - 1999 All rights reserved

Technical data subject to change

C79000-G8276-C159

Printed in the Federal Republic of Germany

Siemens Aktiengesellschaft

## SIMATIC HMI

## WinCC

Manual  
Volume 1 / 2

### Volume 1

Preface	1
System Overview	2
Authorization	3
WinCC Explorer	4
Channels	5
Report Designer	6
User Administrator	7

### Volume 2

Graphics Designer	8
Alarm Logging	9
Tag Logging	10
Text Library	11
Global Script	12
Cross Reference	13

This manual is part of the documentation package with the order number: 6AV6392-1XA05-0AB0

Edition August 1999

WinCC®, SIMATIC®, SIMATIC NET®, SINEC® and STEP® are Siemens registered trademarks.

All other product and system names in this manual are (registered) trademarks of their respective owners and must be treated accordingly.

(The reproduction, transmission or use of this document or its contents is not permitted without express written authority. Offenders will be liable for damages. All rights, including rights created by patent grant or registration of a utility model or design, are reserved.)

(We have checked the contents of this manual for agreement with the hardware and software described. Since deviations cannot be precluded entirely, we cannot guarantee full agreement. However, the data in this manual are reviewed regularly and any necessary corrections included in subsequent editions. Suggestions for improvement are welcomed.)

© Siemens AG 1994 - 1999 All rights reserved

Technical data subject to change

C79000-G8276-C159

Printed in the Federal Republic of Germany

Siemens Aktiengesellschaft

# Preface

## Purpose

The WinCC User Guide<sup>®</sup> describes:

- the structure and function of WinCC and its components
- how to set up system-specific WinCC projects
- how to use WinCC at runtime

The User Guide is for WinCC V5.

## Position within the Information Environment

The User Guide is part of the documentation on SIMATIC<sup>®</sup> HMI<sup>®</sup>. All the documentation on WinCC is listed below.

Installation Basics	Getting Started	WinCC Basic Documentation Vols. 1 and 2	Configuration Manual	Communication Manual	Channel Descriptions
Options	User Archives Redundancy Client Server	Pro Agent			
Options in Process Control	Basic Process Control	Process Control Runtime			
Development Support	Open Developers Kit	Channel Developers Kit			

Documentation	Contents
Getting Started	Uses a configuration example to show beginners how to proceed step by step through a project, and introduces WinCC's overall functionality.
WinCC V5 Volume 1: System Overview Software Protection ControlCenter Server Data Channels Report Designer User Administrator  Volume 2: Graphics Designer Alarm Logging Tag Logging Text Library Global Scripts CrossReference	Supplies information <ul style="list-style-type: none"> <li>• on interrelationships in WinCC</li> <li>• on how software protection works</li> <li>• on the structure, method of operation and use of WinCC Explorer</li> <li>• on variables and variable groups</li> <li>• on communication between WinCC and the process</li> <li>• on creating and editing layouts for printing in Report Designer</li> <li>• on assigning user rights in User Administrator</li> <li>• on generating process maps in Graphics Designer</li> <li>• on configuring, processing and archiving messages in Alarm Logging</li> <li>• on configuring, processing and archiving measured values in Tag Logging</li> <li>• on configuring multiple-language texts in Text Library</li> <li>• on compiling C functions and actions in Global Script</li> <li>• on generating lists of cross-references with Cross Reference</li> </ul>
Configuration Manual Volumes 1, 2 and 3	Supplies information <ul style="list-style-type: none"> <li>• on configuring in WinCC, with examples for illustration</li> <li>• on special aspects of configuring</li> <li>• on the development environment for scripts, C functions and actions (C course)</li> <li>• on the graphics objects in Global Library</li> </ul>
Communication Manual Volumes 1 and 2	Supplies information <ul style="list-style-type: none"> <li>• on links to SIMATIC via PROFIBUS, Industrial Ethernet and OPC</li> <li>• on communication drivers and how they are configured, using examples for general links by way of illustration</li> <li>• on special aspects of configuring</li> </ul>
Channel descriptions	Supply information for communication drivers <ul style="list-style-type: none"> <li>• on addressing variables in the automation system</li> <li>• on parameterizing the communication partners</li> </ul>

Documentation	Contents
WinCC Options User Archives Client Server Redundancy	Supplies information on the options <ul style="list-style-type: none"> <li>• User Archives: creating and using user archives</li> <li>• Client-Server: structure and use of WinCC in a client/server system</li> <li>• Redundancy: structure and use of redundant systems</li> </ul>
ProAgent	Supplies information on the ProAgent option (process diagnosis) <ul style="list-style-type: none"> <li>• How to configure system-specific process diagnosis</li> <li>• How to trace process errors and identify their causes</li> </ul>
Basic Process Control	Supplies information on the process-control options of WinCC <ul style="list-style-type: none"> <li>• Storage</li> <li>• Picture Tree Manager</li> <li>• Split Screen Manager</li> <li>• Chipcard</li> <li>• Lifebeat Monitoring</li> <li>• Video</li> <li>• Time Synchronization</li> </ul>
Process Control Runtime	Supplies information on the process-control options of WinCC <ul style="list-style-type: none"> <li>• Operation at runtime</li> </ul>
Open Developers Kit	Explains programmers how to use WinCC's API functions and how to access the data
Channel Developers Kit	Explains how to develop communication drivers for connecting WinCC to any target system



### Additional Support

Please do not hesitate to contact use if you encounter problems in operation. Call + 49 911 895-7000 if you need assistance in solving problems. Remember to have the software ID number at hand to streamline the process: this number is on the software product card.

Lost or defective authorization can be "repaired" on the phone by our Customer Support. The number to dial is + 49 911 895-7200.

### Information about SIMATIC Products

SIMATIC Customer Support offers you wide-ranging additional information on SIMATIC products by way of its online services:

- You can obtain general up-to-date information
  - on the Internet at <http://www.ad.siemens.com/wincc>
  - from the fax polling no. + 49 8765 93 02 77 95 00
- Up-to-date product information and downloads which may be of assistance during operation:
  - on the Internet at <http://www.ad.siemens.de/support/html-00/Index.shtml>
  - from the Bulletin Board System in Nuremberg (SIMATIC Customer Support Mailbox): the number to dial is + 49 911 895-7100.

To dial into our mailbox, use a modem with a maximum baud rate that does not exceed 28,800 bps (i.e. up to V.34) and set its parameters to 8, N, 1, ANSI or dial yourself in via ISDN (x.75, 64 Kbit).

## SIMATIC HMI

## WinCC

Manual  
Volume 1 / 2

### Volume 1

Preface	1
System Overview	2
Authorization	3
WinCC Explorer	4
Channels	5
Report Designer	6
User Administrator	7

### Volume 2

Graphics Designer	8
Alarm Logging	9
Tag Logging	10
Text Library	11
Global Script	12
Cross Reference	13

This manual is part of the documentation package with the order number: 6AV6392-1XA05-0AB0

Edition August 1999

WinCC®, SIMATIC®, SIMATIC NET®, SINEC® and STEP® are Siemens registered trademarks.

All other product and system names in this manual are (registered) trademarks of their respective owners and must be treated accordingly.

(The reproduction, transmission or use of this document or its contents is not permitted without express written authority. Offenders will be liable for damages. All rights, including rights created by patent grant or registration of a utility model or design, are reserved.)

(We have checked the contents of this manual for agreement with the hardware and software described. Since deviations cannot be precluded entirely, we cannot guarantee full agreement. However, the data in this manual are reviewed regularly and any necessary corrections included in subsequent editions. Suggestions for improvement are welcomed.)

© Siemens AG 1994 - 1999 All rights reserved

Technical data subject to change

C79000-G8276-C159

Printed in the Federal Republic of Germany

Siemens Aktiengesellschaft

# Table of Contents

<b>1</b>	<b>System Overview .....</b>	<b>1-1</b>
1.1	Installing WinCC .....	1-5
1.1.1	Entries in the Operating System Start Menu .....	1-5
1.1.2	Entries in the Windows Explorer Pop-Up Menu .....	1-6
1.2	Configuration with WinCC V5.0 .....	1-6
1.2.1	Project Types .....	1-6
1.2.1.1	Single-User Project .....	1-7
1.2.1.2	Multi-User Project .....	1-8
1.2.1.3	Multi-Client Project .....	1-9
1.2.2	Configuring Distributed Systems .....	1-11
1.2.2.1	Packages for Multi-Client Projects .....	1-13
1.2.2.2	Server Configuration .....	1-13
1.2.2.3	Multi-Client Configuration .....	1-14
1.2.2.4	Configuration Example .....	1-23
1.2.3	Configuring Pictures .....	1-25
1.2.4	Configuring Messages .....	1-26
1.2.5	Visualizing Process Data .....	1-27
1.3	Project Documentation .....	1-28
1.4	Integrating WinCC and STEP 7 .....	1-33
1.5	System Properties .....	1-38

controlengineers.ir

# 1 System Overview

## WinCC - the interface between man and machine

WinCC is an industry- and technology-neutral system for solving visualization- and controls-related tasks in production and process automation. It offers function modules for the display of graphics, providing messages, archiving, and reporting which are suitable for use in industry. Its high-performance process coupling, fast picture updating, and reliable data archiving ensure high availability.

In addition to these system functions, WinCC provides open interfaces for user solutions. This makes it possible to integrate WinCC into complex, company-wide automation solutions. Archive data access via ODBC and SQL, as well as the linking of objects and documents via OLE2.0 and ActiveX Controls, are integrated. These mechanisms make WinCC a competent, communicative partner in the Windows world.

The foundation for WinCC is the Windows NT 32-bit operating system. Windows NT features preemptive multitasking, which ensures fast reactions to process events and provides a great deal of protection against data loss. Windows NT also offers functions which focus on safety. WinCC software is itself a 32-bit application which was developed using modern, object-oriented software programming techniques.

If WinCC is started via the Start Menu, the WinCC Explorer is opened first. From here, the various editors can be accessed in which the various specialized tasks of a given operating and monitoring system are performed.

## The WinCC Editors

### Graphics Designer

The Graphics Designer is a vector-oriented drawing program for creating process pictures. Numerous graphic objects, which are contained in an object and styles palette, can also be used to create complex process pictures. Dynamics can be added to individual graphic objects by means of action programming. Wizards provide support by automatically generating frequently used dynamics and linking them to objects. You can store your own graphic objects in a library.

### Alarm Logging

Alarm Logging provides displays and operating options for acquiring and archiving results. You can freely select the message blocks, the message classes, the message type, the message display, and the report. The System Wizard and the configuration dialogs provide support during configuration. To display messages in runtime, the Alarm Control which is contained in the object palette of the Graphics Designer is used.

### Tag Logging

Tag Logging is used for acquiring data from running processes and for preparing them for display and archiving. The data formats of the archives and the acquisition and archiving timers can be freely selected. The display of the process values is made via the WinCC Online Trend and Table Controls, which display the data in trend and table form, respectively.

**Report Designer**

The Report Designer is an integrated reporting system for timer- or event-controlled documentation of messages, operations, archive contents, and current or archived data in the form of user reports or project documentation in freely selectable layouts. It provides a comfortable user interface with tool and graphic palettes and supports the various report types. Various standard system layouts and print jobs are available.

**Global Script**

Global Script is the generic term for C functions and actions which, depending on type, can be used within a given project or within numerous projects. Scripts are used to configure actions to objects. They are processed using a system-internal C compiler. Global Script actions are used at runtime in process execution. Their execution is initiated by a trigger.

**Text Library**

In the Text Library, you can edit texts which are used in runtime by the various modules. The foreign language output texts are defined in the Text Library for the configured texts. These are then output in the selected runtime language.

**User Administrator**

The User Administrator is used for allocating and controlling access authorizations of the users for the individual configuration- and runtime-system editors. When a user is set up, the access rights for the WinCC functions are set and individually assigned to the respective user. Up to 999 different authorization can be allocated. User authorizations can be allocated at system runtime.

**Cross Reference**

Cross Reference is used to find and display all points of use for objects, e.g tags, pictures, and functions. With the "Linking" function tag names can be changed without causing inconsistencies in the configuration.

**WinCC Basic Options****Client Server**

With its client-server functionality, WinCC can be used to operate several coordinated operating and monitoring stations in a common interconnection with networked automation systems. Up to 64 subscribers can theoretically be integrated in a single project.

**Redundancy**

WinCC Redundancy offers the possibility to operate two coupled server-PCs in parallel so that they can monitor one another. Should one of the two server computers fail, the second server assumes control of the entire system. After the server which failed is brought back into service, the contents of all message and process archives are copied to the server which was out of service.

**User Archives**

WinCC User Archives is a database system which the user can configure himself. Data from technical processes can in this way be continuously stored on a server PC and displayed online in runtime. Moreover, recipes and setpoint assignments for the connected controls can be stored in the User Archives and passed on to the controls as necessary.

## WinCC Process Control Options

### Storage

The storage functions support the automatic swapping of data from the hard disk to long-term data media as well as the deleting of data on the hard disk.

### Picture Tree Manager

The Picture Tree Manager is used to manage a hierarchy of systems, subsystems, function names, and Graphics Designer pictures.

### Time Synchronization

Time Synchronization is a function for systems with SINEC L2/L2R bus systems. Here, one WinCC operator station acts as the active time master and controls the synchronization of all other operator stations and automation systems connected to the system bus with the current time. This makes it possible to chronologically order messages for the entire system.

### Lifebeat Monitoring

Lifebeat Monitoring is used to constantly monitor the individual systems (operator station and automation system) and visualizes the results as screen displays in the runtime system, automatically triggers the horn component, and generates the automation system messages.

### Base Data

Base Data is used for configuring the basic WinCC data by means of Wizards.

### Split Screen Wizard

The Split Screen Wizard is a component of the Split Screen Manager. This is used for configuring and initializing the monitor and screen settings for the current WinCC project. You should perform this initialization immediately after creating a project, as other applications (runtime, group display, etc.) access these data.

### Alarm Logging Wizard

The Alarm Logging Wizard is used for configuring and initializing the message window, messages, message classes and systems of the automation system messages, and the horn signalling device for the current WinCC project.



## Communication between WinCC and the control unit

The following connections are available for the communication between WinCC and the various controls.

### Communication types in combination with SIMATIC S5

- serial via programming interface (AS511 protocol)
- serial via 3964R (RK512 protocol)
- Ethernet layer 4 (via data handling blocks)
- Ethernet TF (technological functions)
- S5-PMC Ethernet (PMC communication) Option
- S5-PMC Profibus (PMC communication) Option
- S5-Profibus-FDL Option

### Communication types in combination with SIMATIC S7

- MPI interface (S7 protocol)
- PROFIBUS (S7 protocol)
- Industrial Ethernet (S7 protocol)
- TCP/IP
- SLOT PLC
- S7-PMC PROFIBUS (PMC communication)

### Mixed operation SIMATIC S5 / S7

SIMATIC S5 and SIMATIC S7 controls can be connected in parallel in the same network and exchange data with WinCC. SIMATIC S7 uses only the S7 protocol.

### Communication with other controls

- |                            |                   |        |
|----------------------------|-------------------|--------|
| • Manufacturer-independent | Profibus FMS/DP   | Option |
| • AEG Modicon              | Modbus serial     | Option |
| • Allen Bradley            | DF1 serial        | Option |
|                            | Data Highway      | Option |
|                            | Data Highway+     | Option |
|                            | Highway 485       | Option |
| • GE Fanuc                 | SNP/SNPX protocol | Option |

## 1.1 Installing WinCC

### 1.1.1 Entries in the Operating System Start Menu

Upon installation of WinCC, several links to auxiliary programs are established in the \SIMATIC\WinCC folder of the Start Menu.

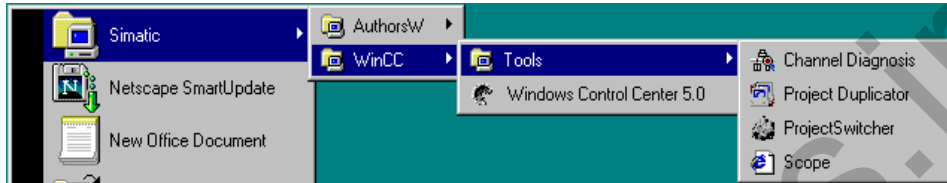

#### Channel Diagnosis

Use WinCC "Channel Diagnosis" to obtain an overview of the status of the configured channels and their links to the PLC.

#### WinCC - Project Duplicator

Use the WinCC Project Duplicator to duplicate a completed project. In combination with the WinCC Redundancy option, the Project Duplicator is used to create functionally identical projects.

---

#### Note

Additional information about the WinCC - Project Duplicator can be found in the Redundancy manual.

---

#### WinCC - Project Switcher

The "WinCC Project Switcher" is used to switch-over projects of the client between two redundant servers. In the event of a server failure, a switch-over to the redundant partner server can be performed automatically. As a result, the client is not affected by a server failure, as its project is taken over by the partner server.

---

#### Note

The configuration of the WinCC Project Switcher of V4.02 cannot be used for V5.0. The Project Switcher must be configured again for V5.0.

Additional information about the WinCC - Project Switcher can be found in the Redundancy manual.

---

#### WinCC-Scope

WinCC Scope supports you during WinCC diagnostic work. WinCC Scope is based on Internet technology. An Internet browser, such as the Internet Explorer or the Netscape Navigator, is required to start the "CCDiagAgent" diagnosis program. The TCP/IP protocol must also be installed.

#### Windows Control Center

The WinCC Explorer is started by activating the "Windows Control Center" button.

## 1.1.2 Entries in the Windows Explorer Pop-Up Menu

Upon installation of WinCC, the following additional entries are added to the Windows Explorer pop-up menu "File" "New":

Entries	Description
WinCC Document	Creates a file named "New WinCC-Document.MCP" in the selected folder.
WinCC.Graphics.Document	Creates a file named "New WinCC.Graphics.Document.pdl" in the selected folder.
WinCC CrossRef Document	Creates a file named "New WinCC CrossRef Document.xfc" in the selected folder.

## 1.2 Configuration with WinCC V5.0

### 1.2.1 Project Types

The following terms are used in the descriptions of the individual project types.

Term	Meaning
Client	A client that has been permanently assigned to a server in a multi-user project. The client can be used in a multi-user project or in a distributed system.
Multi-Client	As of WinCC V5.0, a multi-client can access data on up to 6 servers. The multi-client is not a component of this server project.
Server	Server of a multi-user project with client and multi-clients. A redundant server pair can also represent a server.
Functional Distribution	Various servers take on different tasks in specific areas of the process.
Technological Distribution	Different servers take on all necessary area-specific tasks.

### 1.2.1.1 Single-User Project

A single-user project is a single-operator terminal. The configuration, operation, as well as the connection to the process bus and storing of project data, are performed on this computer.

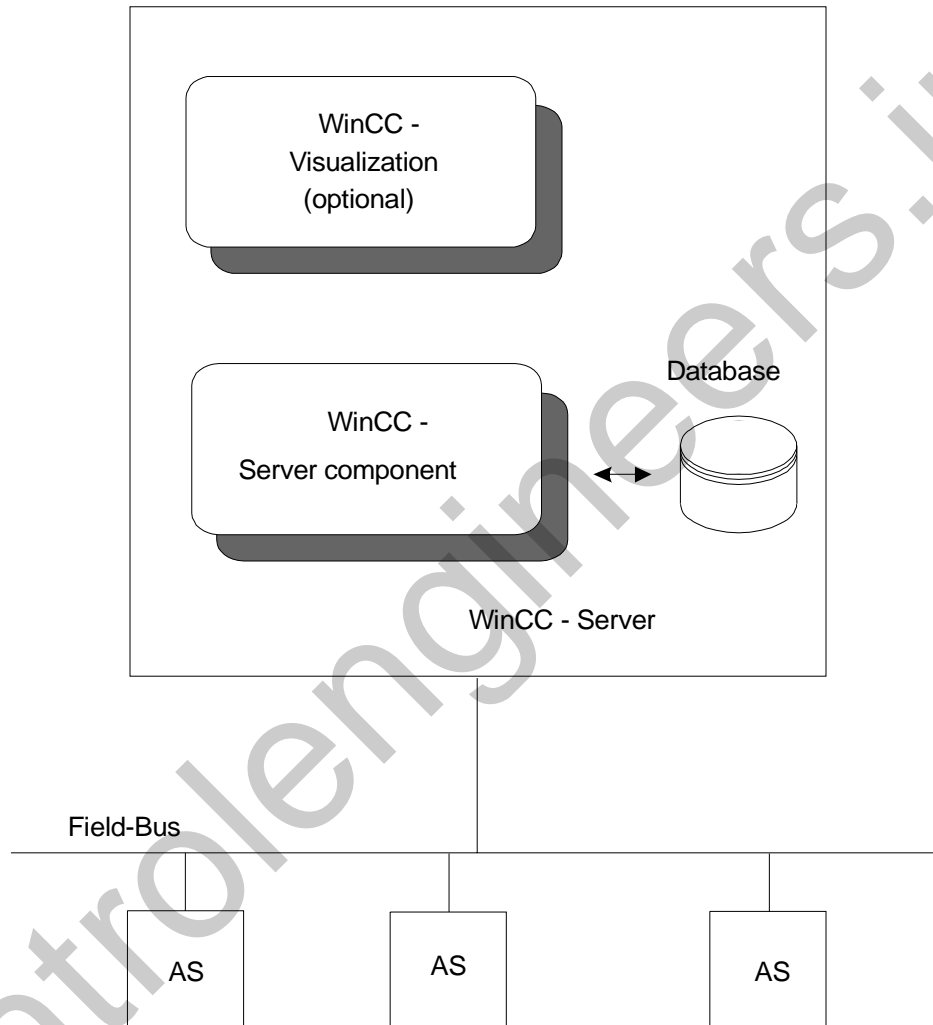

### 1.2.1.2 Multi-User Project

A multi-user project is characterized by multiple clients and one server, all of which work with the same project. Here, up to 16 clients can access a single server. Configuration can take place on the server or on any of the clients. Project data such as pictures, tags, and archives are preferably stored on the server and are made available to all clients. The connection to the process bus and the processing of the process data are implemented by the server. Runtime is usually operated from the clients.

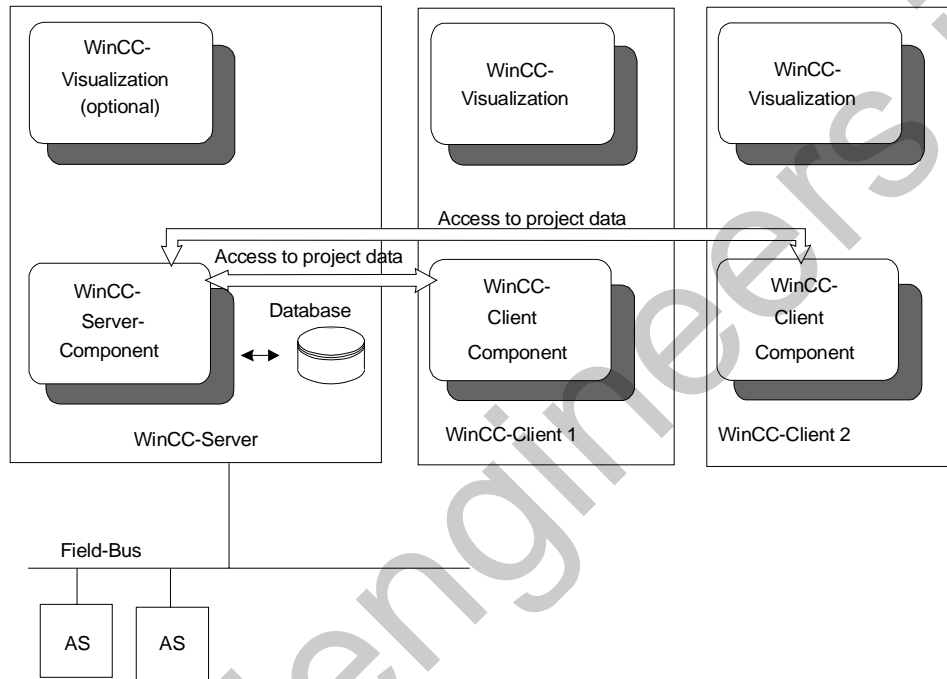

### 1.2.1.3 Multi-Client Project

Each multi-client project is a project type that can access the data of multiple servers. Each multi-client and the associated servers have their own project. The configuration of the server project is performed on the server or on the clients; the configuration of the multi-client project is performed on the multi-client.

A server can be accessed by up to 16 clients or multi-clients. In runtime, a multi-client can access up to 6 servers. This means that, for example, the data from 6 different servers can be visualized on one picture of the multi-client. The following picture illustrates an example of how the various servers appear on the multi-client during runtime.

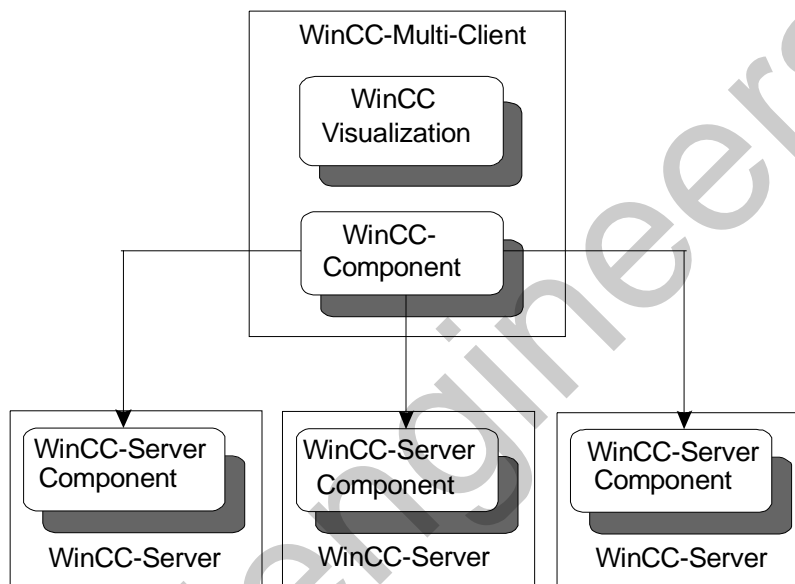

#### Technological Distribution:

The various referenced servers perform the same tasks, i.e. message archiving, measurement value archiving, and process data linking. However, each server considers a different logical system section. In an application structured around subsystems, the servers are connected to different PLCs independently of each other. In PCS7 the form of logical distribution is primarily used.

#### Note

It is recommended to structure systems in accordance with technological distribution; the functional distribution is created only by means of a specific configuration.

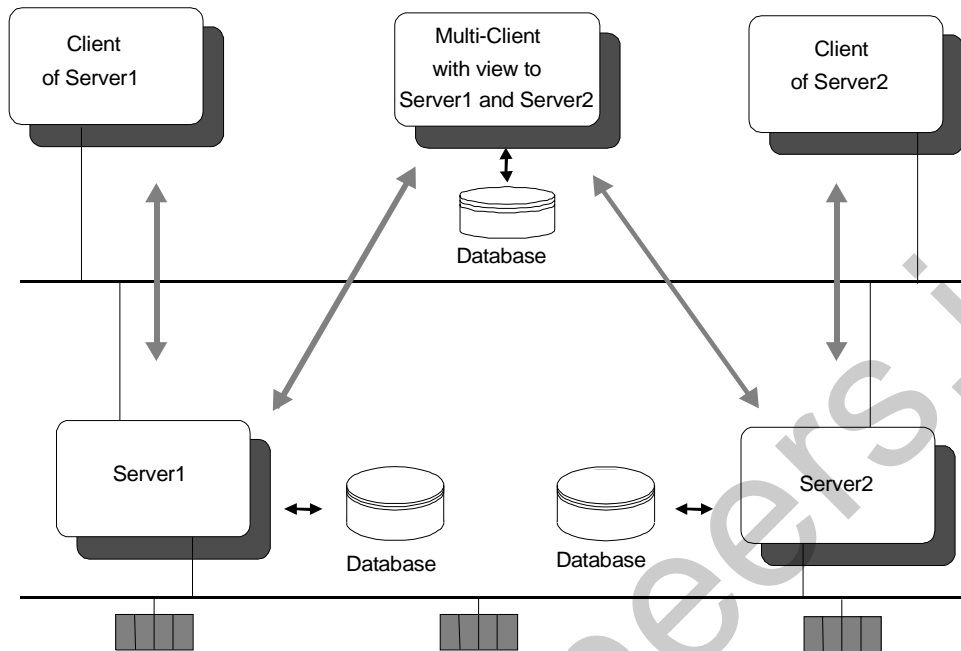

#### Functional Distribution:

The various referenced servers in a multi-client project perform various tasks. For example, one WinCC server performs the archiving, another one the message processing and a third one the process data linking.

#### Note

Tags required for the server operation must also be configured on the message and archive servers. Message and archive servers do not access the data server to determine the process data.

## 1.2.2 Configuring Distributed Systems

Distributed systems can be created as of Version 5.0. This means that 2 to 6 servers can be operated and monitored by one client, the so-called multi-client.

Here, distinctions can be drawn between three fundamentally different types of operation.

1. Multi-client operation of all server pictures from an overview picture or, for PCS7, from an overview area (no picture change required).
2. Integration of single/multiple pictures of single/multiple servers into one picture (picture-in-picture method).
3. Creation of pictures containing tags of different servers.

### Level 1

The following steps are required:

- Generate all packages of the participating servers and load them onto the multi-clients.
- For WinCC (native): Make the start pictures of the server projects selectable from an overview picture.
- For WinCC in the PCS7 environment, proceed as follows:

The following steps illustrate the configuration of a distributed system in the PCS7 environment.

1. Create a server project using the Split Screen Wizard and the Alarm Logging Wizard.
2. Configure the picture hierarchy using the Picture Tree Manager.
3. Configure the user authorizations in the User Administrator.
4. Generate the packages on the servers.
5. Create a multi-client project using the Split Screen Wizard.
6. Load the packages.
7. Configure the Life Beat Monitoring functions on the multi-client.
8. Configure the user authorizations in the User Administrator of the multi-client.

You can now display all server pictures on the multi-client and navigate among them as usual.

---

#### Note

If all servers are accessed via multi-clients, it is possible to disconnect the regular "V4.0 clients". The freed PCs can be used for other purposes.

---



**Level 2**

Level 2 finds its application mainly in the creation of overview pictures. The layout must be designed in such a way that multiple pictures can be displayed simultaneously. Pictures from previous WinCC versions can be reused. (see Chapter 1.2.2.3)

Multi-Client

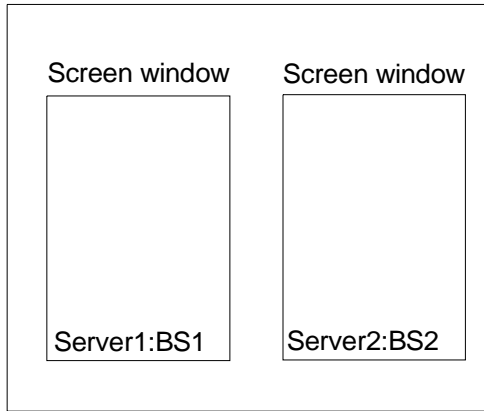

Picture: Picture-In-Picture Method

**Level 3**

Level 3 finds its application mainly in the creation of pictures (also overview pictures), in which data of several servers are to be displayed, but without using the picture-in-picture method. The picture is directly connected to the tags of the servers. (see Chapter 1.2.2.3)

Multi-Client

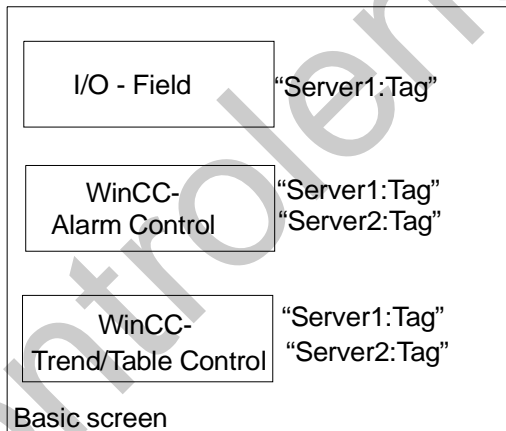

Picture: Picture configuration with connection to different servers

### 1.2.2.1 Packages for Multi-Client Projects

In order to be able to access the relevant data on a server in a multi-client project in runtime, packages are used. The packages contain symbolic names of project-relevant data such as pictures, tags, messages, and archives. Packages must be generated on the servers and be loaded onto the multi-client. The generation and loading can be performed in runtime as well as in the configuration system.

After changing the configuration data of server projects, the packages must be generated again. The "Update" function updates the packages on the multi-client.

---

#### Note

It is the user's responsibility to update the local packages.

---

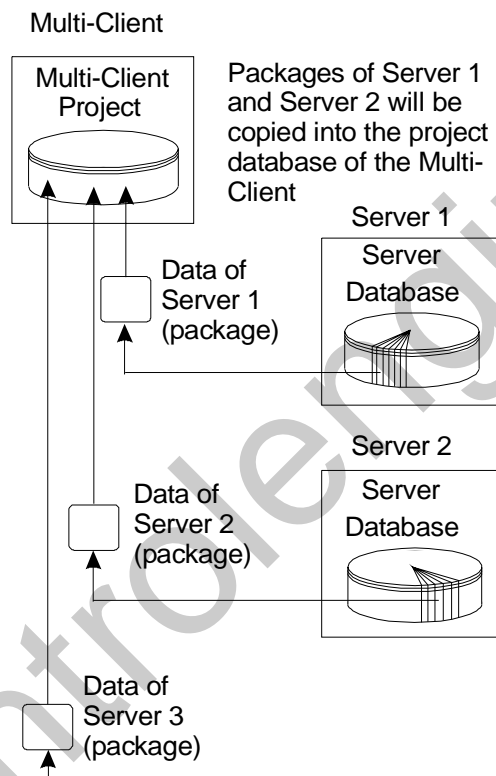

### 1.2.2.2 Server Configuration

A multi-user project with or without clients is created on the server. A server project cannot be configured from a multi-client. Also, the activation and deactivation of server projects cannot be performed from a multi-client. These types of tasks can be performed by one of the clients integrated in the distributed system.

### 1.2.2.3 Multi-Client Configuration

A multi-client has its own local project data, e.g. pictures, scripts, and internal tags. From the multi-client, only the data of the multi-client project, not the server project, can be changed. The server projects can be accessed via references to tags, messages, archives and pictures. Thus, the multi-client provides a view of the data of one or more servers.

#### Tag Configuration

In the configuration system, no changes to data type or name can be made from a multi-client to tags configured on the servers.

The values of the tags configured on the servers can be changed in runtime.

---

#### Note

When configuring a server project, a distinction is made between tags with computer-local updates and tags with project-wide updates.

The value of a tag on a server having computer-local updates cannot be changed from a client. However, these tags can be changed on a server from a multi-client.

---

#### Configuring Pictures on a Multi-Client

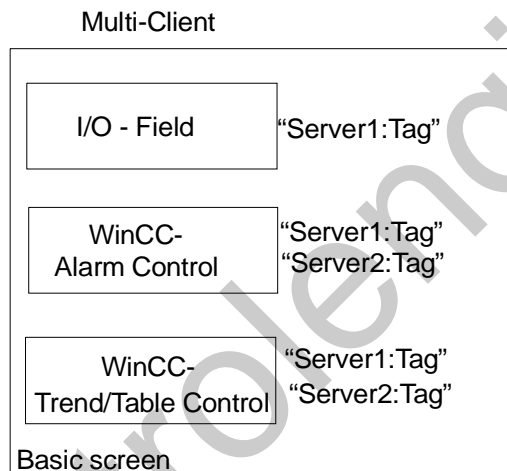

The basic picture and all objects contained therein are configured on the multi-client. Each basic picture can be used to access data from multiple servers. It is possible to design the pictures of the multi-client specifically for the multi-client.

A picture configured on the multi-client can be copied to other multi-client projects. To do so, the server packages addressed in the copied pictures must be loaded on all multi-clients.

An I/O field can be connected to a local tags or to tags referenced via packages. Messages to be displayed in a message window can originate from multiple servers. In a trend window, the tags of different servers can be displayed.

#### Tags in Pictures

On the multi-client, the configured server tags of all packages are provided in the tag selection dialog.

### C Functions in Pictures

The C functions used in the pictures must be present in the multi-client project in order to be executed. Project functions and standard functions are valid throughout the project and can therefore also be used by the multi-clients. However, they must first be copied from the server to the multi-clients. For further information, refer to the "Script Processing" section of this chapter.

### Note

To avoid problems with user-written functions, which must also be copied, the use of the standard functions is recommended.

### Configuring Pictures on a Server

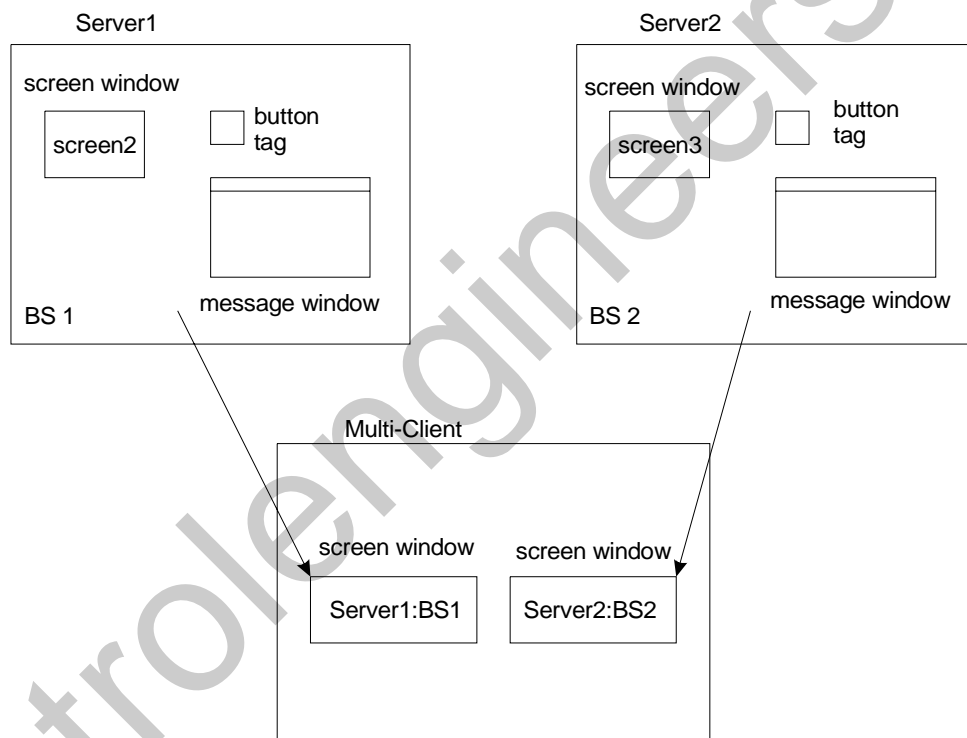

The pictures BS1 and BS2 are configured on Server1 and Server2, respectively. The basic picture is configured on the multi-client. The contents of the picture windows in the basic picture of the multi-client are provided by both servers. The data of multiple servers can be used only in a basic picture configured on a multi-client. Each picture window can access the data of one server.

**Note**

When configuring picture changes, "Direct Connection" must be used.

The use of generic API functions within actions is not recommended.

Due to the multi-client's behavior during the processing of server tags with computer-local updates, such tags should not be referenced.

To execute project functions from server pictures on a multi-client, these project functions must also be present on the multi-client.

The Diagnostics Control displays the state of the "local" Global Script, i.e. if a server picture containing a Diagnostics Control is opened on the multi-client, the multi-client will be analyzed.

The size of the basic pictures must be adapted to the size of the picture windows.

**Displaying Process Data**

The application windows used up to now are replaced by two new controls:

	V4.02	V5.0
Process Tags as Trends	Application Window	WinCC Online Trend Control
Process Tags as Tables	Application Window	WinCC Online Table Control

The following table illustrates the functionality of application windows; application windows that have been converted to controls; and new controls in server, client, and multi-client projects.

	Server	Client	Multi-Client
Application Window (In V5.0 it is only possible to display old pictures; configuration is not possible.)	Full functionality	Full functionality	No functionality
Converted control	Full functionality	Full functionality	Without reconfiguration it is only possible to access the standard server
Control newly created (Online configuration possible via the Graphics Designer)	Full functionality	Full functionality	Full functionality

On the multi-client, V4.02 pictures cannot access multiple server projects. Only the standard server of the multi-client can be accessed. Application windows configured in V4.02 can be converted in the Graphics Designer. A reconfiguration is only required if special functions of the new controls are to be used (e.g. trend window with display of multiple servers).

---

**Note**

To convert individual V4.02 application windows, the appropriate picture must be opened in the Graphics Designer.

To convert all pictures containing application windows to V5.0, the "Convert Pictures" menu option is provided in the Graphics Designer in the Editors menu. If script functions of the Alarm Logging application window are used, they must be replaced in these pictures.

Further information on using and configuring the standard server can be found in the Server Data manual.

---

Since the behavior of the Trend and Table Controls is identical with regard to specific multi-client features, only the Trend Control is described below.

1. The display of a control in a server picture offers the possibility of central configuration.
  - It is possible to display the tags of this server from the multi-client.
  - It is not possible to modify the server picture from the multi-client.
  - No persistent changes can be made from the multi-client.
  - Trend and Table Controls of a server picture can be configured online from the server or from a client.
  - The server picture can be edited from a client.
2. The display of a control in a multi-client picture offers the possibility of decentral configuration.
  - Trend and Table Controls in a multi-client picture can be configured online from the multi-client.
  - It is possible to display the tags of multiple servers in a control from the multi-client.
  - Persistent changes of controls in a multi-client picture can be performed via the Graphics Designer from the multi-client.

In WinCC V5.0, controls can be added to the Graphics Library as templates. This function is available on servers, clients and multi-clients.

---

**Note**

The "Configure Trends Online" function also allows trends to be configured on the multi-client. Storing takes place on the multi-client's preferred server. The trend group can be retrieved by all multi-clients that have set up this server as their preferred server.

---

The following illustrates the steps necessary to configure a Trend Control in a picture on a multi-client. The Trend Control will display the measured values of different servers.

1. Configure Tag Logging on the servers. This includes the creation of the process value archives and the tags.
2. Use Server Data to create packages in order to be able to access the process value archives in the multi-client project.
3. Create the multi-client project.

4. Load the packages from the relevant servers.
5. Depending on the display type, insert either the Online Trend Control (trend display) or the Online Table Control (table display) into the Graphics Designer picture.
6. Select the "Elements" tab from the Quick Configuration dialog.
7. Use the Selection button to select archives and tags (Server::Archive Name\Tag Name).
8. Save the picture in the Graphics Designer.

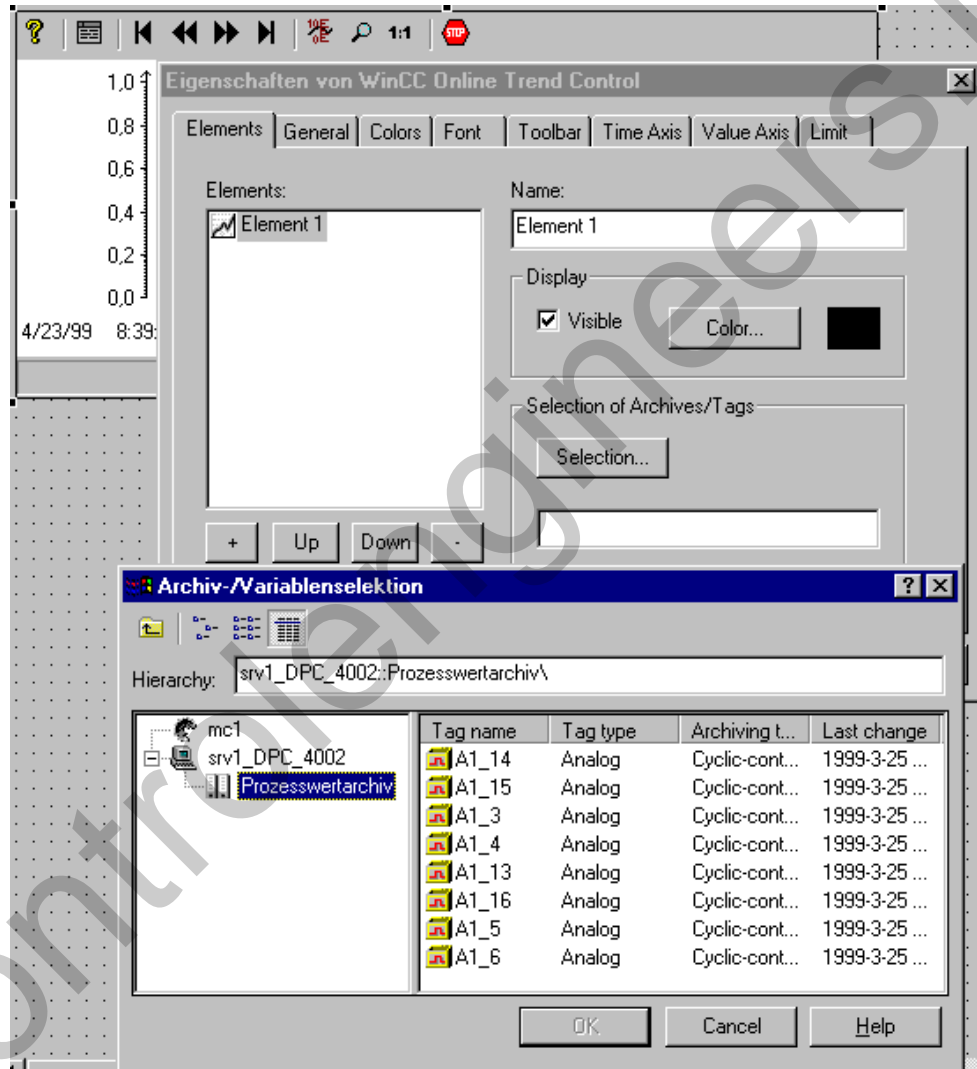

#### Note

If you would like to use controls in your pictures that have the same or similar settings, configure a "template" control and store it in the library.

## Displaying Messages

The application windows/controls used up to now have been replaced by the "WinCC Alarm Control".

	V4.02	V5.0
Messages	Application Window	Alarm Control
	Alarm Control	

The following table illustrates the functionality of application windows; application windows that have been converted to controls; and new controls in server, client, and multi-client projects.

	Server	Client	Multi-Client
Application Window	Full functionality	Full functionality	No functionality
Converted control	Full functionality	Full functionality	Without reconfiguration it is only possible to access the standard server
Control newly created	Full functionality	Full functionality	Full functionality

The multi-client cannot access server projects via application windows. Application windows/controls configured in V4.02 can be converted in the Graphics Designer. A reconfiguration is only necessary if special functions of the new controls are used. If the "OnBtn..." functions were used to operate the message window, these functions are not automatically converted. Instead, they must each be manually changed to the "AXC\_..." functions.

### Note

To convert individual V4.02 application windows/controls, the appropriate picture must be open in the Graphics Designer. To convert all pictures containing application windows/controls to V5.0, the "Convert Pictures" menu option is provided in the Graphics Designer in the Editors menu. If script functions of the Alarm Logging application window are used, they must be replaced in the pictures.

Messages from different servers can be displayed on one multi-client. However, printing messages from different servers in one message sequence report from a multi-client is currently not possible.

The following illustrates the steps necessary to display messages from different servers on one multi-client in WinCC V5.

1. Configure the message systems on the servers. This includes the creation of single and group messages as well as the definition of the message type displays.
2. Use the Server Data function to generate the packages in order to be able to access the single messages, group messages, and message types in the multi-client project.
3. Create the multi-client project.



4. Load the packages from the relevant servers.
5. Insert the WinCC Alarm Control into the Graphics Designer picture.
6. Select the relevant (or all) servers from the Quick Configuration dialog.

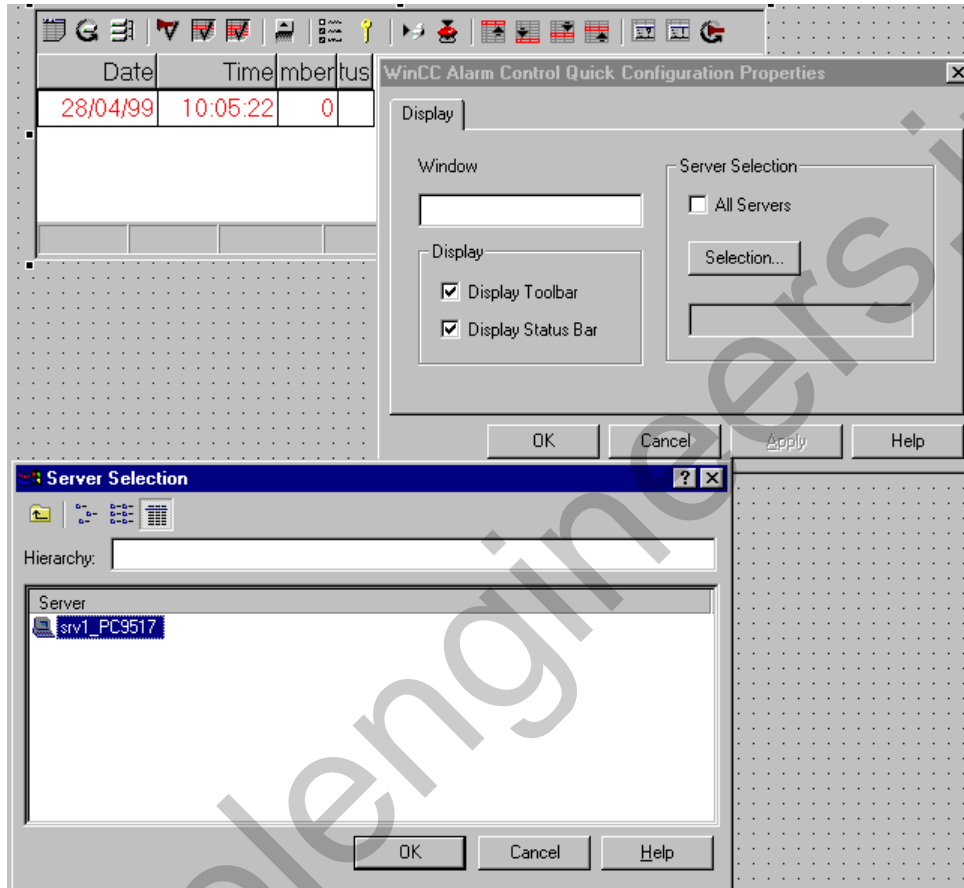

7. Configure the message window via the Alarm Control's Properties dialog.

If an Alarm Control is integrated into a basic picture of a multi-client, executing the "Loop in Alarm" function opens the associated server picture as the basic picture on the multi-client. A return to the initial basic picture is not possible.

If an Alarm Control is integrated into a picture window on a multi-client, executing the "Loop in Alarm" function opens the associated server picture in the picture window. A return to the initial basic picture is possible via the appropriate button in the multi-client's basic picture.

In user-defined scripts, the server reference must be specified manually via "GetServerTagPrefix".

---

#### Note

If you would like to use controls in your pictures that have the same or similar settings, configure a "template" control and store it in the library.

---

## Script Processing

Global Script actions on the server are only available to clients, not multi-clients.

Computer-local script actions are only available to those clients for which they have been configured.

A Global Script can only be used in a project-specific manner on a multi-client. The actions are available only within the multi-client project.

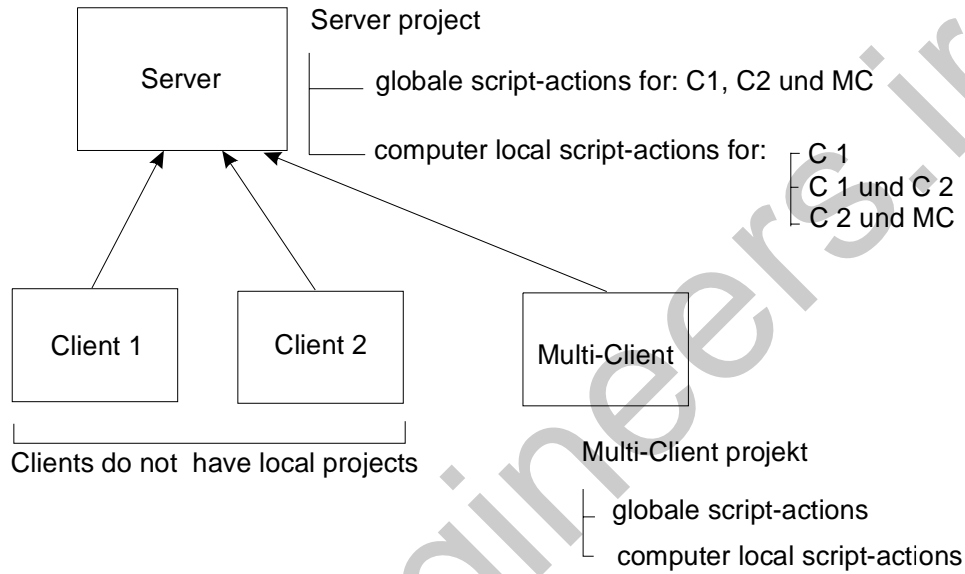

The multi-client has no access to the actions of the server, it can only access its own scripts. Since no other clients/multi-clients have access to projects of a multi-client, a multi-client does not differentiate between global and computer-local scripts.

---

**Note**

In order to use the function for finding the places in which tags or picture names are used in the "Cross Reference" editor, the tags and picture names which are used in C actions must be defined in the script.

At the beginning of the script, all tags and picture names used must be declared in two sections.

These sections have the following structure:

```
// WINCC:TAGNAME_SECTION_START
// syntax: #define TagNameInAction "DMTagName"
// next TagID : 4 // the next free ID can be entered here
# define TAG_1 "otto" // where "otto" is the actual tag name
# define TAG_2 "hugo"
# define TAG_3 "karl"
// WINCC:TAGNAME_SECTION_END

// WINCC:PICNAME_SECTION_START
// syntax: #define PicNameInAction "PicName"
// next PicID : 4
# define PIC_1 "pict1.pdl"
# define PIC_2 "pict2.pdl"
# define PIC_3 "pict3.pdl"
// WINCC:PICNAME_SECTION_END
```

The call of the standard functions for reading and writing the tags must then be carried out via the defined tags and pictures.

```
GetTagDWord( TAG_1 );
OpenPicture( PIC_1 );
SetPictureName ( PIC_2 , "PictureWindow1", PIC_3 );
```

If you generate a new C action in the Graphics Designer, the corresponding pre-made sections will be inserted into your script.

---

### 1.2.2.4 Configuration Example

In the following example, the creation of a multi-client project and the generation and loading of the package are described.

1. A server project is created with the "Multi-User Project" project type. The required pictures, archives, or tags are created on the server.
2. Afterwards, the "Server Data" function is used to generate the package, which is then available to the multi-clients.

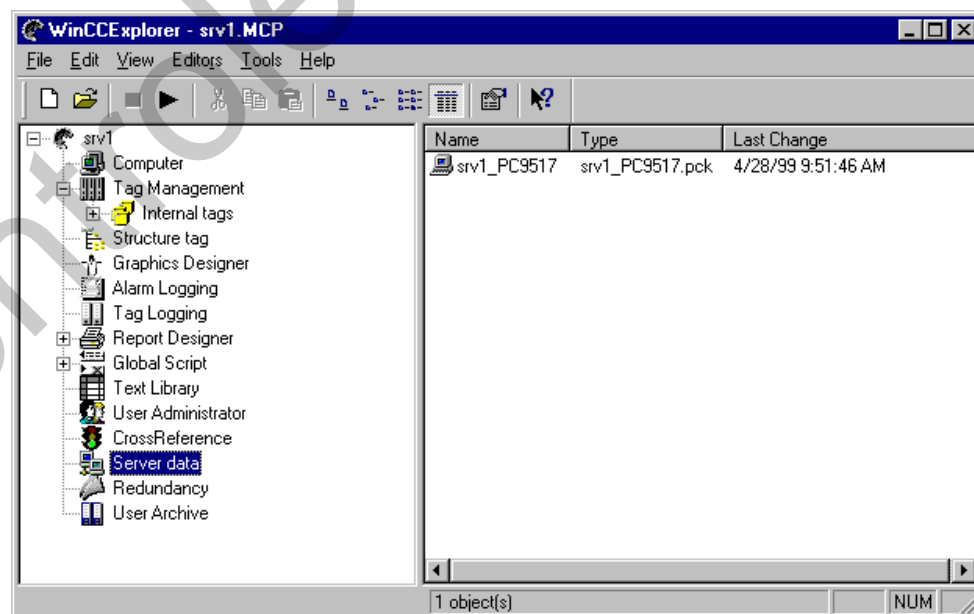
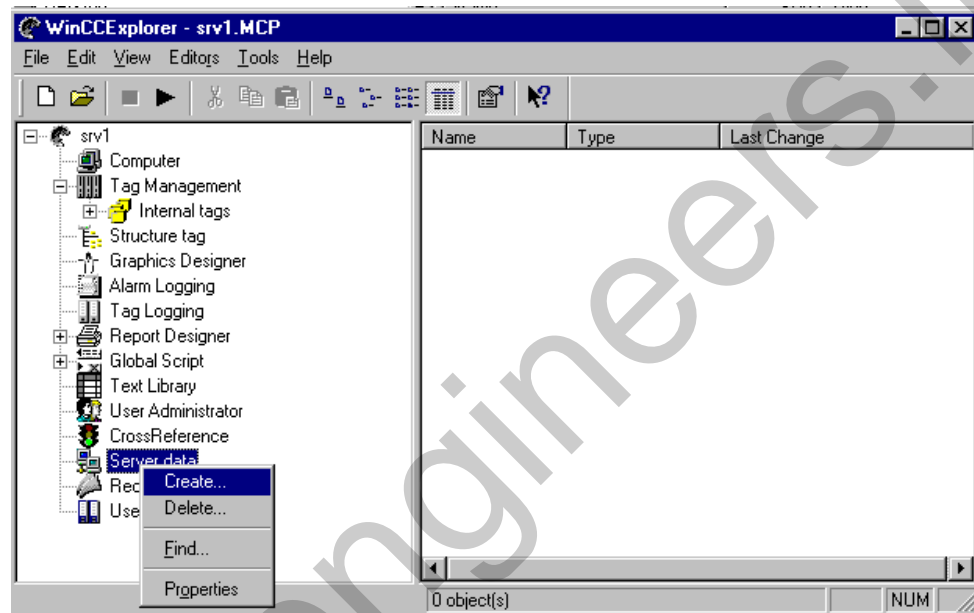

3. Create a new project on a multi-client.
4. On the multi-client, the packages are imported via the "Load" command (Server Data). This procedure can also be performed in runtime. If changes are made to the packages on the servers, steps 2 and 4 must be repeated. The project data of the servers are now available to the multi-client.

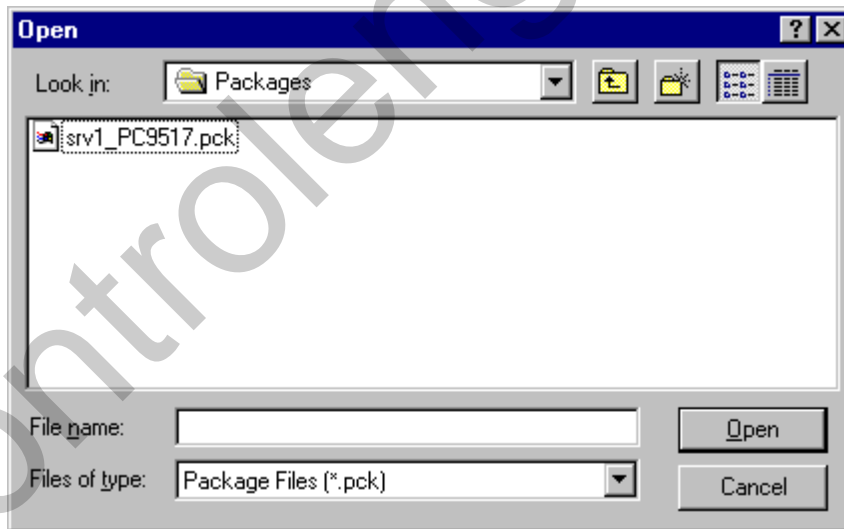
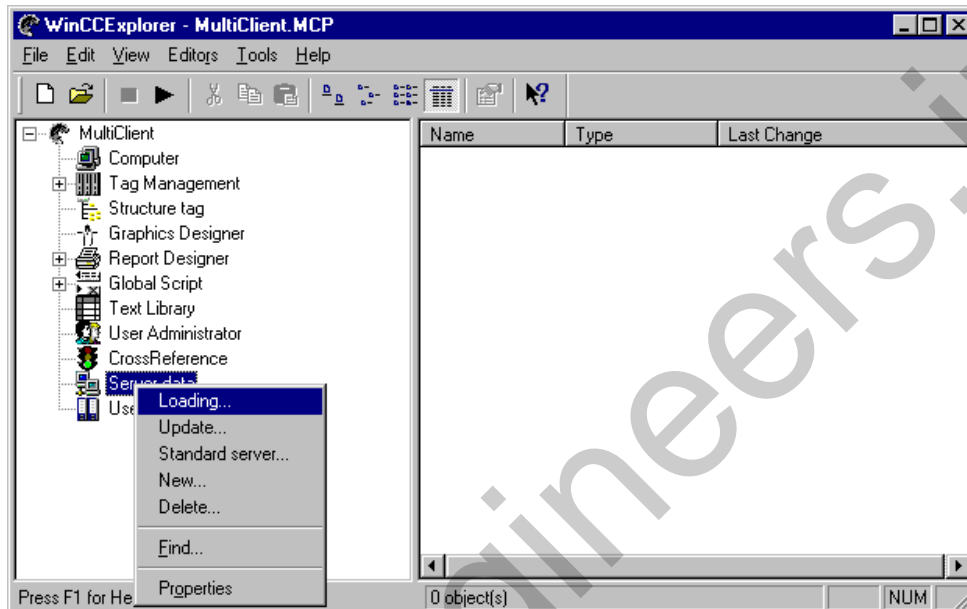

#### Note

By default, the server packages are stored under:  
 ..\ServerProjectName\ComputerName\Packages\ProjectName\_ComputerName.pck.

During the load process, packages stored on any data medium can also be accessed.

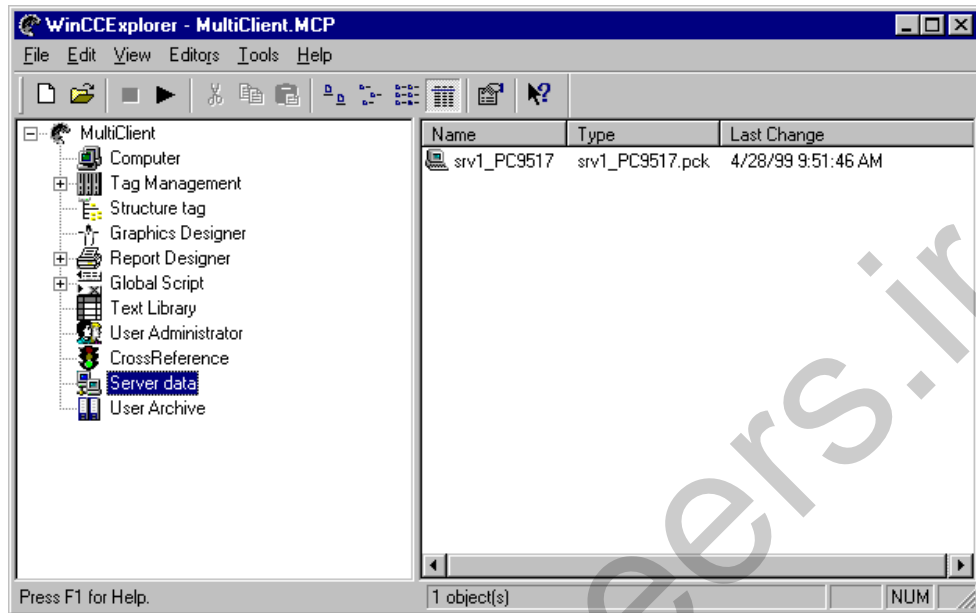

5. Configure the basic picture for the multi-client. In picture windows, pictures configured on the servers can be referenced.

### 1.2.3 Configuring Pictures

The Graphics Designer is used to create process pictures. It offers the user the following features:

- Easy to use, simple interface with tool and graphic palettes
- Streamlined configuration with integrated object and icon libraries
- Open interfaces for importing graphics; OLE 2.0 interface support
- Configurable dynamic behavior of picture objects with support from an assistant (Dynamic Wizard)
- Links to additional functions by means of powerful script configuration
- Links to graphic objects that you can create yourself
- 32-bit application, executable under Windows NT.

## 1.2.4 Configuring Messages

How to Construct a Messaging System:

1. Use the System Wizard to create the basic structure of the message system.
  - The System Wizard
2. Configure the message blocks in accordance with your requirements.
  - Configuring Message Blocks
3. Configure the message system.
  - Configuring Message Classes
  - Configuring Message Types
  - Configuring Single Messages
  - Configuring Group Messages
4. Set the type of data archiving.
  - Configuring Archives
  - Configuring Records
5. Configure the WinCC Alarm Control System in the "Graphics Designer" to display the messages in runtime.
  - The WinCC Alarm Control System.

---

### Note

Use the available Wizards and configuration dialogs to completely create the messages.

---

## 1.2.5 Visualizing Process Data

Tag Logging is used to:

- Set the data format of a continuous archive.
- Set the acquisition and archiving timers.
- Configure process value archives and compressed archives.

### How to Configure Tag Logging:

1. Set the data format of the continuous archives.
  - Data Format of Continuous Archives
2. Configure the acquisition and archiving timers you require.
  - Acquisition and Archiving Timers
3. Configure the required process value archives.
  - Configuring Process Value Archives
  - Configuring the Tags in Process Value Archives
4. Configure the required compressed archives.
  - Configuring Compressed Archives
  - Configuring the Tags in Compressed Archives
5. If necessary, configure the WinCC Online Trend Control in the "Graphics Designer" to display the process values in trend form.
  - WinCC Online Trend Control.
6. If necessary, configure the WinCC Online Table Control in the "Graphics Designer" to display the process values in table form.
  - WinCC Online Table Control.



## 1.3 Project Documentation

### Print Project Documentation

The "Print" command prints out the project documentation of an open editor on the set printer.

The page layouts used are described in the appendix to the Control Center in the "Page Layouts Used" table.

---

#### Note

This command can only be executed, if the page view is closed.

---

### View Project Documentation

The "Page View" command allows you to check the page layout in the page view before it is printed out. The page is displayed just like it is going to be printed.

The view can be switched or the print job be activated via the buttons. The page layout depends on the editor used.

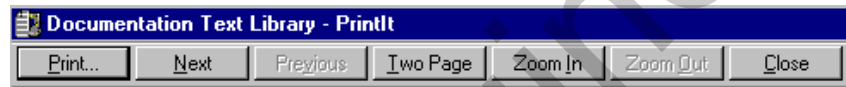

Button	Menu Command	Hot Key
Print...	This command activates the print job on the set printer. After the print job has finished, the page view will automatically be exited.	CTRL + D
Next	This command moves to the next page in your document.	CTRL + N
Previous	This command moves to the previous page in your document.	CTRL + V
Two Page View	This command displays two print pages side by side.	CTRL + Z
Enlarge	This command enlarges a section.	CTRL + G
Reduce	This command reduces a section.	CTRL + K
Close	This command closes the page view.	CTRL + K

### Project Documentation Setup

The "Project Documentation Setup" function allows you to make special print job settings. The dialog box contains three tabs.

Tab	Description
Print Job	In this tab, general information pertaining to the print job can be entered.
Selection	In this tab, the page range and time range of the data to be printed can be entered.
Printer Setup	In this tab, the output device of the print job is defined. You can also print to a file.

### Project Documentation Setup: "Print Job"

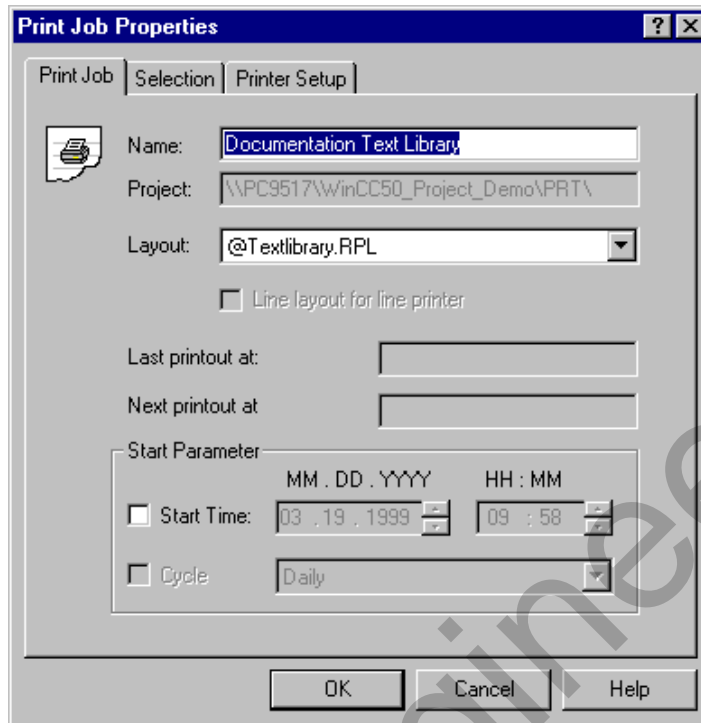

Element	Description
Name	Enter the name of the print job here. Within the project, the name must be unique and adhere to the Windows conventions.
Project	The project name and complete path of the print job is displayed here. This field can not be edited.
Layout	A layout is assigned to the print job here. The layout must already exist. If no layout is entered and another tab is opened, a message box is displayed reminding you that you work with a system print job, which requires a layout.
Line Layout for Line Printer	This check box is only enabled for the "@Report Alarm Logging RT Message sequence" system print job. If you use this system print job and mark the check box, you will use a line layout.
Last Printout On:	The date of the print job's last printout is displayed here. This field can not be edited, it only serves information purposes.
Next Printout On:	The date of the print job's next printout is displayed here. This field can not be edited, it only serves information purposes.
<b>Start Parameters</b>	
Start Time	The start time and date of the print job is entered here.
Cycle	The cyclical activation of the print job can be defined here. Before that, the start time and date of the print job must have been defined. The following cycles are available: <NONE>; Hourly; Daily; Weekly; Monthly

## Project Documentation Setup: "Selection"

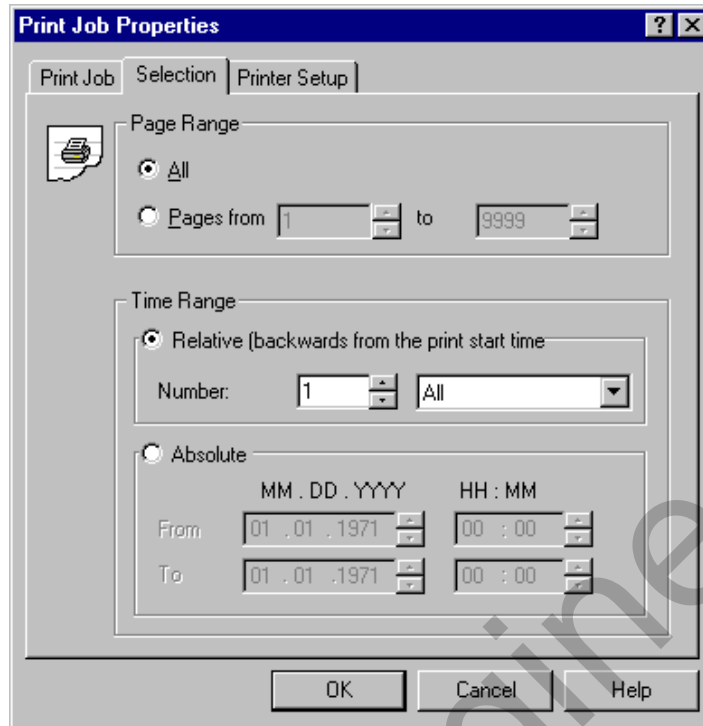

Element	Description
Page Range	
All	All pages of the print job will be printed.
Page nnn to nnn	Define the output of individual pages or page ranges of the print job here.
Time Range	Select from a relative or absolute time range. The time range not used will be grayed out.
Relative	This switch allows you to define a relative time range for a print job, e.g. prints out the messages received in the last 3 hours prior to the start of the print job. For the relative time range, the following options are available: All; Years; Months; Weeks; Days; Hours; Minutes
Absolute	This switch allows you to define an absolute time range.

### Project Documentation Setup: "Printer Setup"

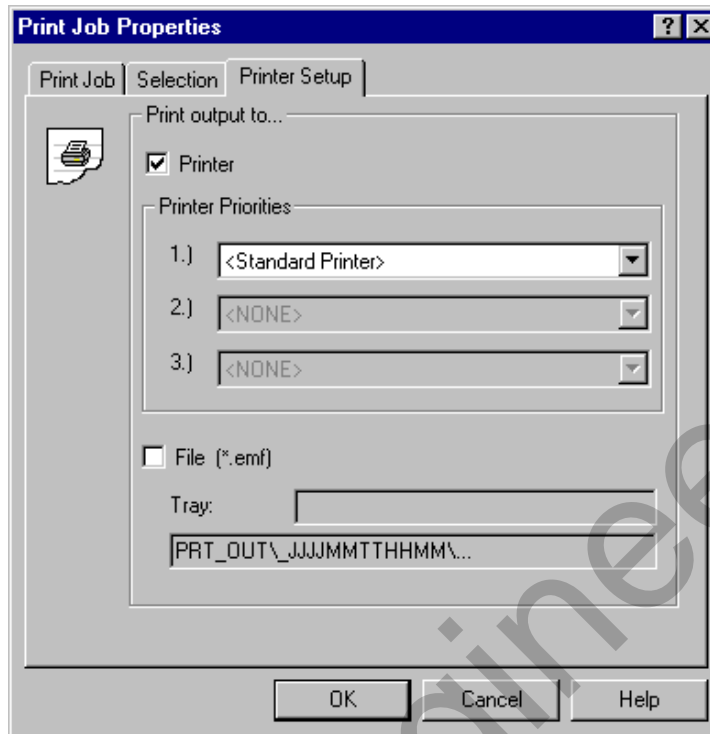

Element	Description
Print Output to Printer	If you mark this check box, the "Printer Priorities" will be enabled and you can select the desired printer.
Printer Priority 1	Enter the first printer here. The system will always attempt to use this printer. If this printer is not ready, the second priority printer will be activated.
Printer Priority 2	Enter the second printer here. The system will always attempt to use this printer, if the first printer is not ready. If this printer is not ready, the third priority printer will be activated.
Printer Priority 3	Enter the third printer here. The system will always attempt to use this printer, if the first and second printers are not ready.
Print Output to File	<p>If you mark this check box, the pending print jobs will be rerouted to a file. The file will be in the "Enhanced Metafile" format.</p> <p>In the "Tray" field, specify the path in which the file is to be stored. The path name is composed of: the project path (e.g. "C:\VFSWinCC\PRT\") and &lt;Tray&gt; + &lt;YYYYMMDDHHMM&gt; (YYYY = Year, MM = Month, DD = Day, HH = Hour, MM = Minute).</p>

#### Note

Additional information about the "Print Job Properties" dialog box can be found in the description of the "Report Designer" editor.

### Page Layouts Used

The editors/components use different page layouts - that have been associated fixed with the print jobs - for printing or (page) viewing the project documentation. These different page layouts are described in the Online Help.

controlengineers.ir

## 1.4 Integrating WinCC and STEP 7

In order to simplify the work between WinCC and STEP 7, special functions have been introduced.

- Ladder Rung Jump
- Return from Ladder Rung Jump
- Diagnosing Hardware
- Tag Selection Dialog
- Integrating an Existing WinCC Project into a STEP 7 Project

### Ladder Rung Jump

With the Ladder Rung Jump function, it is possible to jump directly from WinCC Runtime to the appropriate network (FUP, KOP, AWL) from STEP 7 with focus on the STEP 7 icon belonging to the process tag. It is used for fast and easy diagnosis of errors. The Ladder Rung Jump function is configured on an object created in WinCC via the Dynamic Wizard. Insert, for example, the "Button" Windows object into a picture. Start the Dynamic Wizard and select the Ladder Rung Jump function from the standard dynamics.

The Dynamic Wizard then guides you through the following three points:

- Selecting the dynamic
- Selecting the trigger
- Setting the options

An appropriate trigger for a button is the left or right mouse click event.

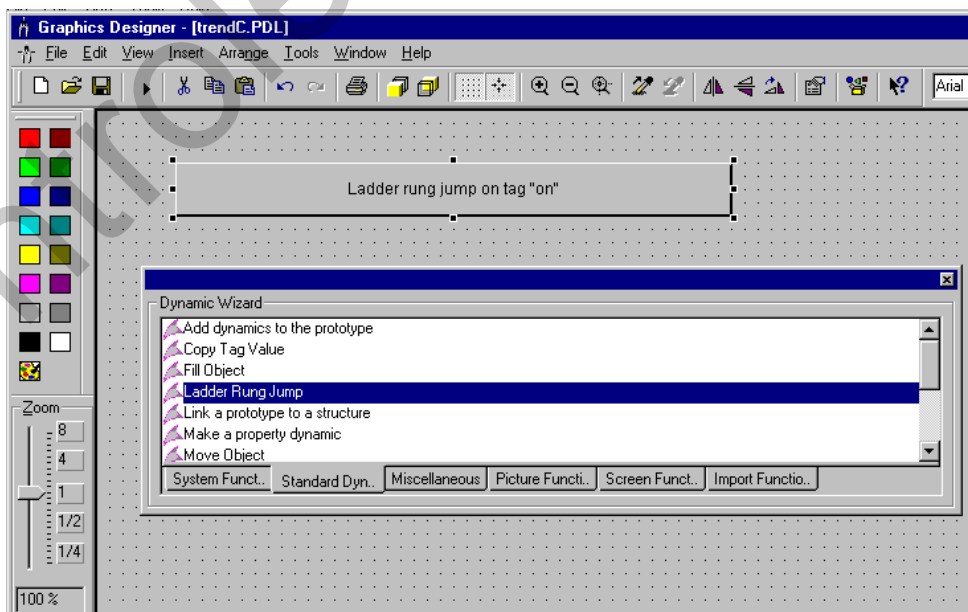

---

**Note**

Proper function of the Ladder Rung Jump function is ensured only when the data in the "Cross Reference" editor correspond to the current project data. Additionally it must be ensured that unique program names are used in the configured STEP 7 project.

---

**Configuration Rules for a Ladder Rung Jump in STEP 7**

To make the information available to WinCC, the following configuration rules for the STEP 7 project must be observed:

For the correct program to be found during a Ladder Rung Jump, programs in a STEP 7 project must have unique names. Since STEP 7 always assigns the same program names (S7-Programm(1)), the names must be changed by the configurator.

**Return from Ladder Rung Jump**

If no spring is made from WinCC, it is not possible to return from STEP 7 to WinCC. The Return from Ladder Rung Jump function makes it possible to display from a STEP 7 icon the place of use of the corresponding WinCC tags. The relationships of STEP 7 icons to WinCC tags is established via the STEP 7 and WinCC cross-reference lists. Distinctions between various alternatives are made when returning from Ladder Rung Jump.

**One-time use of the WinCC tags**

Using the WinCC cross-reference list (Cross Reference), WinCC determines in which pictures the corresponding tag is used. If this tag is used in exactly one picture, this is the picture to which is returned.

**Multiple use of WinCC tags**

Using the WinCC cross-reference list (Cross Reference), WinCC determines in which pictures the corresponding tag is used. If the tag is used in several pictures, a selection dialog is presented in which the picture which is to be returned to can be selected.

**Using WinCC tags in a picture window**

The Ladder Rung Jump function can also be used in projects in which the pictures which are to be displayed are contained in a picture window of the base picture.

---

**Note**

If a return from Ladder Rung Jump and then a switch to STEP 7 via the <ALT><TAB> key combination was performed, the return should not be performed again, otherwise a correct screen generation cannot be ensured.

If the Ladder Rung Jump function is executed and <ALT><TAB> is used to switch back to WinCC and navigation commands are performed therein, the picture stored in the picture hierarchy at the time the Ladder Rung Jump function was executed is displayed upon return.

The proper function of the Ladder Rung Jump function can be ensured only when the data of the "Cross Reference" editor correspond to the current project data.

---

## Diagnosing Hardware

This function allows you to implement a direct start of the diagnosis in runtime, activated by a configurable event at an object.

If the event occurs, the "Diagnosing Hardware" function of STEP 7 for the associated PLC will be started. In order to use the function, the following requirements must be met:

- The WinCC project containing the screen from which the function is activated and the STEP 7 project must be located on the same computer.
- The WinCC project must be set up as a subfolder of the STEP 7 project (STEP 7Project\wincproj\WinCCProject).
- The S7 tags must be mapped to the WinCC tags.

At the current object, define the event that will trigger the function, e.g. a "Left Mouse Button Click" on a button. In addition, the selected WinCC tag will be connected to a (user-) defined property of the current object, e.g. to the background color of the button. This property is controlled by the content of the WinCC tag upon change of the tag value. If the trigger event (e.g. a left mouse button click) occurs at the concerning object in runtime, the "Diagnosing Hardware" function of STEP 7 will be activated for the associated PLC.

### Configuration: Diagnosing Hardware

The "Diagnosing Hardware" function allows the direct jump from WinCC runtime to the corresponding STEP 7 function of the associated PLC. This allows a fast and easy diagnosis of errors. The "Diagnosing Hardware" function is configured in WinCC at a Graphics Designer object with the aid of a WinCC standard function. Proceed as follows:

- In a screen, insert, for example, the Windows Object "Button".
- Connect the selected WinCC tag to a property (defined by you) of the current object, e.g. to the background color of the button.
- For the trigger at the button, the events right mouse click or left mouse click should be selected.  
As the action of the selected event, call the standard function "GetHWDiag)" using the property name that has been connected to the tag as the parameter.

```
#include "apdefap.h"
void OnRButtonDown(char* lpszPictureName, char* lpszObjectName, char*
lpszPropertyName, UINT nFlags, int x, int y)
{
  GetHWDiag(lpszPictureName, lpszObjectName, "BackColor");
}
```

- The value of the selected tag is set in the corresponding error organizational block (OB) of the S7 program, e.g. in the OB 82 for the diagnosis alarm.

```
L #OB82_EV_CLASS
T MB 100
```

In this example, the flag bit M100.0 is set if a diagnosis alarm is activated and reset if the alarm is cleared.



If the WinCC object is now updated by a change of the tag, you can jump, for example via a right mouse button click, to the "Diagnosing Hardware" function of STEP 7 and view details about the error cause in the PLC.

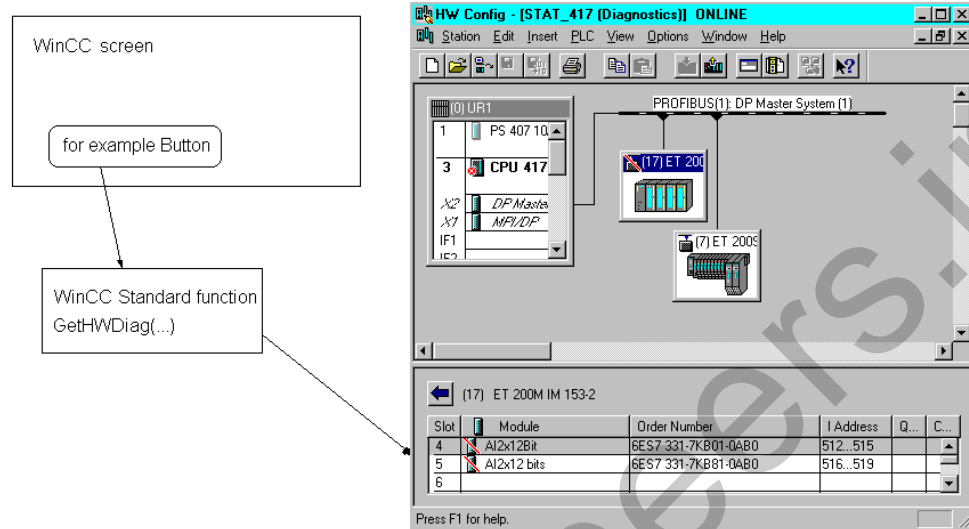

To return WinCC, just close the STEP 7 program "Diagnosing Hardware" or use the <ALT>+<TAB> key combination (which switches you back to WinCC).

Additional information pertaining to the "Diagnosing Hardware" function and the error evaluation in S7 can be found in the "Programming with STEP 7 V5.0" manual, "Diagnosis" chapter.

## Tag Selection Dialog

The tag selection dialog is used to display tags or icons from various data sources via a selection window and, for example, to link them to picture objects of the Graphics Designer.

The data transfer of e.g. STEP 7 icons (SIMATIC S7) is used to display these icons and incorporate them in the WinCC data records.

With the filter function, you can reduce the selection of tags or icons in order to more efficiently perform your search.

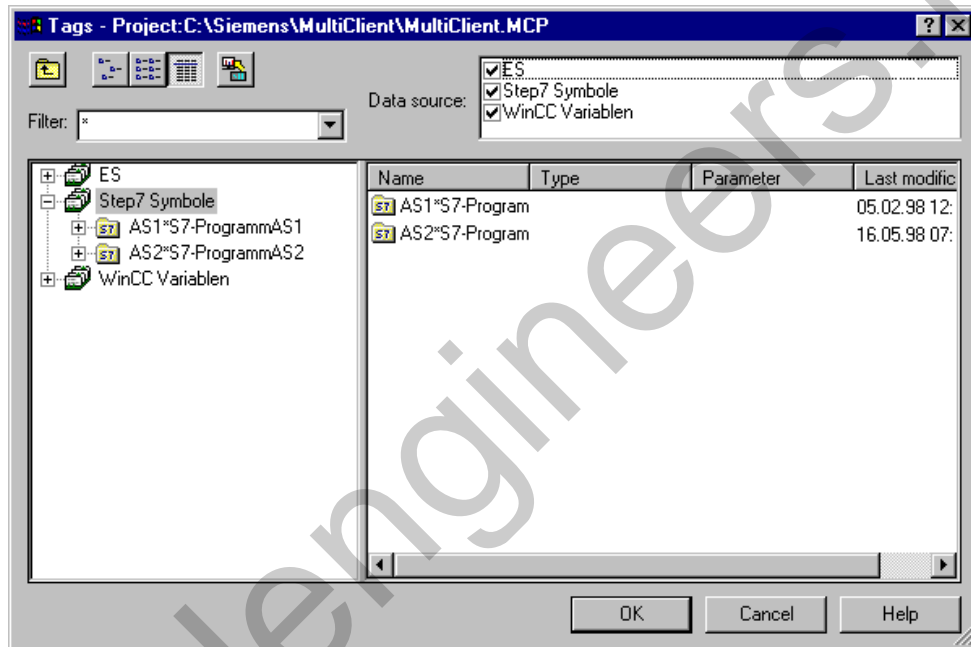

## Integrating an Existing WinCC Project into a STEP 7 Project

To integrate an already existing WinCC project into a STEP 7 project, the following steps are needed:

1. In the STEP 7 project, add an Operator Station and change its name to the existing WinCC project.
2. All files of the existing WinCC project must be copied and stored in the STEP 7 project path at "wincproj\WinCC Project Path".

Example:

The STEP 7 project is named ABC and the WinCC project XYZ. The installation and project path correspond to the defaults.

Source: "C:\Siemens\WinCC\WinCCProjects\XYZ\..."

Target: "C:\Siemens\STEP 7\S7proj\ABC\wincproj\XYZ\..."

If you want to have a different OS name, the name can be changed in the STEP 7 Manager after the integration has been completed. The compression application (Packer) available in STEP 7 permits saving the WinCC project during the archiving of the STEP 7 project, with little storage space required.

## 1.5 System Properties

Important WinCC system properties are described below. These notices should be observed in all cases when using WinCC:

### **Printer output**

When using unfavorable color combinations, e.g. when configuring the message system, some colors cannot be represented when printing to a black/white printer.

### **Hotkey code assigned twice**

A hotkey code that has been assigned twice will not be detected by the system, reported or intercepted. You are responsible for managing the character strings used for hotkeys. A double assignment of a hotkey code will cause problems in runtime.

### **User Archives Table Control**

During configuration, the User Archives Table Control is connected to the selected archive or view, and can then only access this archive or view. To permit access, the archive or view must be enabled. The User Administrator allows you to assign specific rights to the Control. In a multi-client project of WinCC V5.0, each User Archives Table Control can only access one server.

## Index

### A

Alarm Control 1-18  
Alarm Logging 1-1  
Alarm Logging Wizard 1-1  
Application Window  
    Conversion 1-16, 1-18

### B

Base Data 1-1

### C

Client-Server 1-1  
Communication  
    with other controllers 1-1  
    with SIMATIC S5 1-1  
    with SIMATIC S7 1-1  
Cross Reference 1-1

### D

Distributed Systems  
    Configuring tag logging 1-16  
Distributed Systems  
    Configuration 1-11  
    Configuring a multi-client 1-14  
    Configuring the server 1-13  
    Editing scripts 1-20  
    Example of a configuration 1-23  
    Messages 1-18  
    Packages 1-13  
    Representing process data 1-16  
    Table control 1-16  
Distribution  
    Functional 1-9  
    Technological 1-9

### F

Functional Distribution 1-9

### G

Global Script 1-1  
Graphics Designer 1-1

### H

Hardware Diagnosis 1-34  
Hotkey  
    Double-assignment of Hotkeys 1-38

### L

Lifebeat Monitoring 1-1

### M

Messages  
    Configuring messages 1-26  
    Printing messages 1-38  
Multi-Client  
    Configuring alarm logging 1-18  
    Configuring pictures 1-14, 1-15  
    Configuring tag logging 1-16  
    Example of a configuration 1-23  
    Representing process data 1-16  
Multi-Client  
    Configuring Global Script 1-20  
    Configuring tags 1-14  
Multi-Client Project 1-9  
    Packages 1-13  
Multi-User Project 1-8

### N

Network Entry Point 1-33  
Network Return Point 1-34

### P

Packages 1-13  
Picture Names  
    Configuration rules 1-20  
Picture Tree Manager 1-1  
Pictures  
    Configuring pictures 1-25  
Print 1-28, 1-38  
Printer Setup 1-30  
Process Data  
    Configuring tag logging 1-27  
    Visualizing process data 1-27  
Project Documentation  
    Data Selection 1-29

- Print 1-28
- Setup 1-30
- View 1-28
- Project Duplicator 1-5
- Project Switcher 1-5
- Project Type 1-6
  - Multi-Client Project 1-9
  - Multi-User Project 1-8
  - Single User Project 1-7

## R

- Redundancy 1-1
- Report Designer 1-1

## S

- Single User Project 1-7
- Split Picture Wizard 1-1
- Start Menu 1-5
- STEP 7 1-33, 1-37
- Storage 1-1

## T

- Tag Logging 1-1
- Tag Name
  - Configuration rules 1-20
- Tag Selection Dialog 1-36
- Technological Distribution 1-9
- Text Library 1-1
- TIA 1-33
  - Hardware diagnosis 1-34
  - Integration in STEP 7 1-37
  - Network entry point 1-33
  - Network Return Point 1-34
  - Tag Selection Dialog 1-36
- Time Synchronization 1-1
- Totally Integrated Automation 1-33
  - Hardware diagnosis 1-34
  - Integration in STEP 7 1-37
  - Network entry point 1-33
  - Network Return Point 1-34
  - Tag Selection Dialog 1-36

## U

- User Administrator 1-1
- User Archives 1-1
- User Archives Control 1-38

## W

- WinCC User Archives Table Control 1-38
- WinCC-Scope 1-5

## SIMATIC HMI

## WinCC

Manual  
Volume 1 / 2

### Volume 1

Preface	1
System Overview	2
Authorization	3
WinCC Explorer	4
Channels	5
Report Designer	6
User Administrator	7

### Volume 2

Graphics Designer	8
Alarm Logging	9
Tag Logging	10
Text Library	11
Global Script	12
Cross Reference	13

This manual is part of the documentation package with the order number: 6AV6392-1XA05-0AB0

Edition August 1999

WinCC®, SIMATIC®, SIMATIC NET®, SINEC® and STEP® are Siemens registered trademarks.

All other product and system names in this manual are (registered) trademarks of their respective owners and must be treated accordingly.

(The reproduction, transmission or use of this document or its contents is not permitted without express written authority. Offenders will be liable for damages. All rights, including rights created by patent grant or registration of a utility model or design, are reserved.)

(We have checked the contents of this manual for agreement with the hardware and software described. Since deviations cannot be precluded entirely, we cannot guarantee full agreement. However, the data in this manual are reviewed regularly and any necessary corrections included in subsequent editions. Suggestions for improvement are welcomed.)

© Siemens AG 1994 - 1999 All rights reserved

Technical data subject to change

C79000-G8276-C159

Printed in the Federal Republic of Germany

Siemens Aktiengesellschaft

## Table of Contents

<b>1</b>	<b>Software Protection and Authorization.....</b>	<b>1</b>
1.1	The Type of Authorization .....	4
1.2	Full Authorization.....	4
1.2.1	Emergency Authorization .....	5
1.2.2	Powerpack: The upgrade authorization for PowerTags .....	5
1.3	WinCC and Software Protection.....	6
1.3.1	WinCC in Demo Mode.....	6
1.3.2	WinCC with Emergency Authorization .....	6
1.3.3	Exceeding the Permissible Number of PowerTags.....	7
1.3.4	Missing an Option Authorization.....	7
1.3.5	RT and RC Authorizations.....	7
1.4	System Prerequisites .....	8
1.5	Installing Authorizations .....	9
1.5.1	Installation via the WinCC Setup.....	9
1.5.2	Installing with AuthorsW .....	11
1.6	Deinstallation of Authorizations .....	14
1.7	Collecting Authorizations on the Multi-Authorization Diskette.....	17
1.8	Diagnosing Authorization Problems .....	19
1.8.1	Licence.log .....	19
1.8.2	CCAuthorInformation.....	20
<b>2</b>	<b>Upgrading.....</b>	<b>21</b>
2.1	Upgrading the Number of Tags .....	21
2.2	Upgrading the WinCC System .....	22
<b>3</b>	<b>Repairing Authorizations .....</b>	<b>25</b>
3.1	Repairing a Defective Authorization .....	26
3.2	Repair Is Not Possible .....	27
3.3	Contacting Customer Support .....	28
3.4	Authorization Diskette Labels .....	29



controlengineers.ir

## Introduction

### Software has a value

With the purchase of this software, you have acquired the unlimited right to use the software and its functionality. Furthermore, you have a right to (in accordance with our terms and conditions):

- our warranty
- our support
- our service

Our WinCC software is protected against unlawful use. The protected programs are only fully functional, when a valid authorization for the program or software package is found on the hard disk of the respective computer.

The authorization represents the usage rights and thus the actual value.

controlengineers.ir

# 1 Software Protection and Authorization

## The Principle of Authorization

SIMATIC WinCC is, like all other SIMATIC software, equipped with a software protection, thus each installed program requires a valid authorization to enable its full operation. The customer receives this authorization on an authorization diskette with the purchase of a WinCC basic software package). This "Authorization Key" is transferred to the hard disk of the PC and enables the full use of the software installed from the CD-ROM. The software can be installed from the CD-ROM as often as you wish.

The Authorization Key cannot be copied. Without a valid authorization, the WinCC software can only be operated in demo mode.

The authorization can be installed automatically when installing the WinCC software (recommended) or later by the user via the Windows NT Start menu with the handling program, AuthorsW (Authorization program for WinCC Version 5.x). Worldwide, each authorization diskette, which holds a valid authorization for WinCC, has a unique serial number. During the installation, this serial number will be transferred to the computer and can be read with the handling program.

The serial number will be required whenever you make an inquiry, e.g. telephone support.

## Copy Protection Procedure

The Authorization Key cannot be copied. The copy protection method prevents copying an authorization diskette with authorizations or the authorizations themselves onto the hard disk. The method uses encryption techniques and interventions in the physical file structure to prevent the copying of a "functional" authorization for a protected program. Therefore, you cannot make a duplicate of the authorization diskette, but only a backup of the handling program (all the files except the catalog "AX NF ZZ"). As a backup authorization, please use the emergency authorization.

## Authorization Diskette



### Multi-Authorization Diskette

When you order a copy of the WinCC system software, you will receive, in addition to the software on CD-ROM, a yellow multi-authorization diskette holding the number of valid authorizations you ordered. This multi-authorization diskette also has empty "compartments" to hold authorizations for additional WinCC options on the CD-ROM. Thus there can be several valid authorizations - e.g. a WinCC configuration on one computer - put together on a multi-authorization diskette and transferred or installed with a single command on another system.



### Emergency Authorization Diskette

In addition to the multi-authorization diskette, you will also receive a yellow emergency authorization diskette. This holds the emergency authorization that is used in case the full authorization is lost.



### Single-Authorization Diskette

A red single-authorization diskette is delivered with each WinCC option and with the Powerpacks (upgrade for the PowerTags). These single-authorization diskettes contain just the authorization and the emergency authorization for the ordered function.

## Handling the Authorization



AuthorsW.exe

Starting with WinCC Version 5.0, Setup also installs the handling program (AuthorsW), which can be run in English, French, German, Italian or Spanish. Using AuthorsW, you can install or deinstall the authorizations.

You can also use the new handling program, AuthorsW, to install or deinstall the authorizations for prior versions.

When it first installs an authorization on a hard disk, AuthorsW will create a directory named "AX NF ZZ". This directory will be given the attributes "System" and "Hidden" and will be automatically deleted when deinstalling the last authorization.



### Attention

Do not change the name or attribute of this directory, since the installed authorizations can then be irrevocably lost.

---

## Preventing Malfunctions

Deinstall all authorizations before using an optimization program that moves fixed blocks. This also applies for formatting, compressing or restoring the hard disk or installing a new operating system on your computer.

It is not possible to use compressed hard disks or diskette drives.

If a backup includes a copy of an authorization, there is a risk that when the backup files are written back to the hard disk that the still valid installed authorizations will be overwritten and thus destroyed.

Should you lose an authorization, it is possible to restore it.



### Attention

The directory "AX NF ZZ" and its contents may not be changed! During the installation of an authorization, a cluster on the hard disk will be marked as "bad". Do not try to restore this cluster.

Therefore, you must deinstall the authorizations before every backup or exclude them from the backup.

---

## 1.1 The Type of Authorization

## 1.2 Full Authorization

Full authorization is an authorization for unrestricted use of the WinCC software. This authorization will be installed on your computer.

### Note

The name of a full authorization begins with the letter "A" (e.g. "A9...")

The handling program, AuthorsW, is installed with the WinCC Setup and displays the authorization data as follows

Product	Counter	Validity	N.	Network Users	Serial No.	Type
⚡ SIK/SIMATIC WINCC Advanced Process Ctrl	1	Unlimited	A..	-	0000000000	00
⚡ SIK/SIMATIC WINCC Basic Process Ctrl	1	Unlimited	A..	-	0000000000	00
⚡ SIK/SIMATIC WINCC Chipcard	1	Unlimited	A..	-	0000000000	00

"**Product**" is a brief description of the authorization.

"**Counter**" is the authorization counter:

- "1" means that the authorization is valid/activated and can be installed (displays a diskette) or deinstalled (displays a hard disk).
- "0" means that the authorization is on a hard disk (displays a diskette).

"**Validity**" distinguishes between full and emergency authorization

"**Name**" identifies the authorization.

"**Network-User**" gives the number of network users (network authorization). Currently not available.

"**Serial No.**" is the serial number (ID Number KHE) of the authorization.

"**Type**" gives information about the upgrades

### 1.2.1 Emergency Authorization

In the event that the full authorization is no longer available, the emergency authorization serves as a backup of the full authorization. This emergency authorization can then be installed and the operation continued. Its use is limited to 14 days from the date of the first installation, independent of the degree of utilization.

---

#### Note

The name of an emergency authorization begins with X (e.g. "X9...")

After the emergency authorization elapses, the WinCC software will switch to demo mode. Within the 14 day period, the lost authorization can be reacquired from Customer Support.



#### Attention

Changing the PC's time/date will cause early loss of the emergency authorization.

### 1.2.2 Powerpack: The upgrade authorization for PowerTags

The number of PowerTags in a WinCC software configuration can - be increased within a version - by a Powerpack.

Powerpacks are upgrade authorizations. They are available for both the WinCC/RTxxx and WinCC/RCxxx packages. Only one upgrade authorization will be delivered per diskette, together with the associated new emergency authorization. The upgrade authorization can only be used once.

---

#### Note

The upgrade authorization (Powerpack) simply controls the upgrade program and cannot be used for the operation of the WinCC software.



## 1.3 WinCC and Software Protection

The WinCC software can be fully installed from the CD-ROM as often as you wish.

---

### Note

Nearly the full range of the software's functions can be used without authorization. Exceptions include a number of options such as User Archives.

---

### 1.3.1 WinCC in Demo Mode

Without an authorization, WinCC runs in demo mode. This means that the WinCC software is fully useable for one hour. This mode permits the operation of WinCC for test and presentation purposes as well as when making modifications on location, when they only have a RT authorization.

- With a runtime system (RTxxx), after an hour a box will appear, which requests a valid full authorization. This message must be acknowledged and will appear again every 10 minutes.

---

### Note

Even without authorization, the process operation is fully functional without loss of data when archiving or for a message system.

---

- After an hour, the project planning software (RCxxx) will terminate. Before hand, it is possible to save any changes. WinCC Explorer and the runtime system (if present) will continue to run. Each time the editor is restarted, it can be used for another 10 minutes.

If you install an authorization in demo mode, it will first be effective when WinCC is restarted.

### 1.3.2 WinCC with Emergency Authorization

With an emergency authorization, WinCC can be operated for up to 14 days with no restriction in its range of functions (when compared with the replaced full authorization). Once this period of time elapses, WinCC will automatically switch to demo mode.

### 1.3.3 Exceeding the Permissible Number of PowerTags

If the permissible number of PowerTags is exceeded at runtime, WinCC will switch to demo mode. The number of PowerTags will not be checked on a client.

When planning a project without RC authorization, WinCC operates in demo mode. In this case, the editors can be used until the demo mode period elapses.

### 1.3.4 Missing an Option Authorization

If the data for an option or a channel-DLL is entered, unrestricted operation is only possible after all the authorizations are installed. If authorizations are lacking for the options used or a channel-DLL, WinCC will switch to demo mode regardless of which other authorizations are available.

### 1.3.5 RT and RC Authorizations

WinCC distinguishes between **RT authorization** (Runtime) and **RC authorization** (Runtime and Configuration). Another distinction is made with regard to the permissible number of tags.

**RT Authorization** permits the operation of WinCC in runtime mode for an unlimited period of time. The editors can only be used in demo mode for a limited period of time.

**RC Authorization** permits the operation of WinCC in runtime mode and in project planning mode for an unlimited period of time.

**RT xxx / RC xxx** the "xxx" specifies how many external tags can be used in the projects. For an example, with the RC authorization "RC 1024", up to 1024 external tags are permitted.

---

#### Note

With an RT/ RC authorization, a client is always permitted the maximum number of PowerTags (64\*1024), since the number of tags is only checked on a server.

---

## 1.4 System Prerequisites

---

### Note

Before you install or deinstall authorizations, please read the Readme.txt file.

It is only possible to install an authorization on a local drive. You cannot install an authorization on a RAM-drive, diskette or compressed drive.

Exception: With compressed drives, you can install on the associated host drive. The minimum disk space required is 16 MB. As long as you have enough space on the hard disk, you can install as many different authorizations as you like.



### Attention

In the process of installing or deinstalling an authorization, the authorization diskette will be written to in each case. As a consequence, you may not write protect the authorization diskette.

---

## 1.5 Installing Authorizations

When an authorization is installed, it will be deactivated on the diskette and activated on a local drive so that WinCC can use this authorization.

There are two methods of installing your WinCC authorization:

- **automatically** during the installation of the WinCC software. Setup guide you through the installation (recommended).
- **later** with the handling program, AuthorsW.

### 1.5.1 Installation via the WinCC Setup

Setup installs the authorization, while installing WinCC. This is performed in the following steps

#### Registration

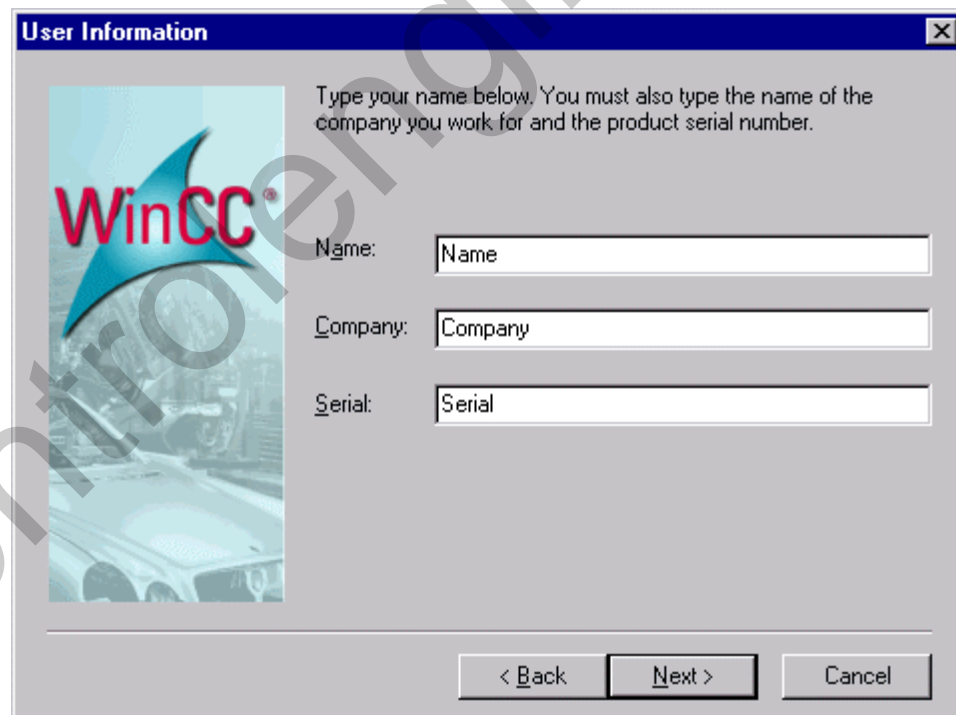

**User Information**

Type your name below. You must also type the name of the company you work for and the product serial number.

Name:

Company:

Serial:

< Back    Next >    Cancel

#### Note

The serial number (10-places) is found on the authorization diskette, on the software product certificate and via the handling program's display function.

## Authorization

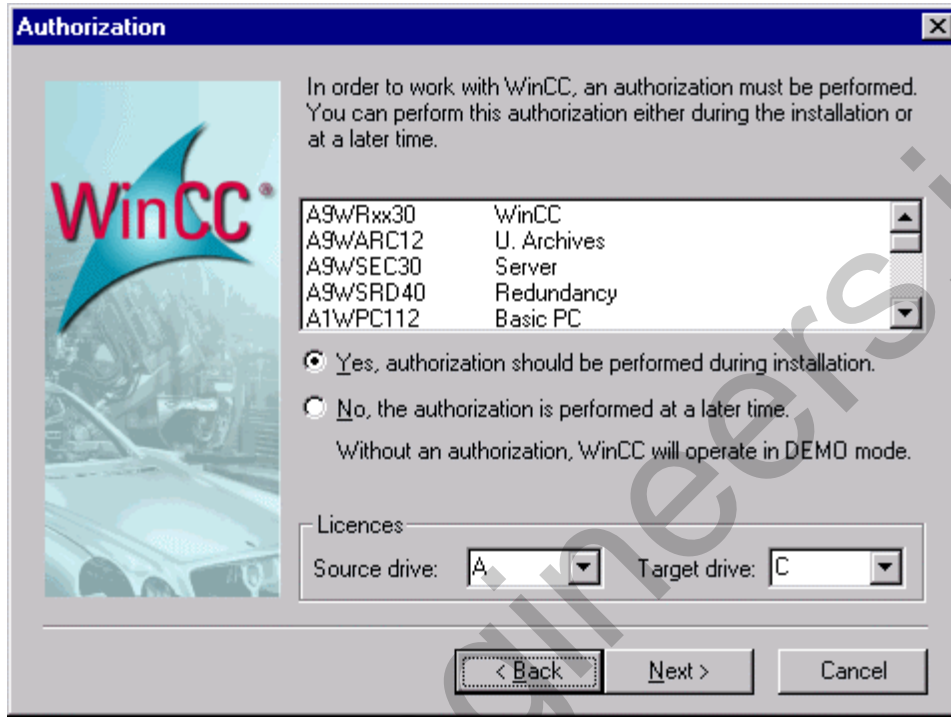

- Select "Yes, the authorization should be performed during the installation"

The authorizations required by WinCC will be displayed in the Setup mask, which also used to select the source and destination drives.

### Insert the authorization diskette

If A: is the source drive, you only need to acknowledge the request to insert the authorization diskette.

#### Attention

The diskette may not be write protected.

## 1.5.2 Installing with AuthorsW

To install/deinstall authorizations, you need the program AuthorsW. Starting with WinCC Version 5, Setup will automatically install AuthorsW along with WinCC. You can install AuthorsW V2.0.3 over an existing installation of AuthorsW V2.0. For more information about this, read the accompanying README file on the AuthorsW diskette.

After the installation, you will find a shortcut to AuthorsW in the Windows Start menu.

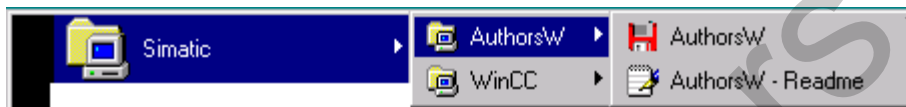

AuthorsW displays existing authorizations via the "Managing Authorizations" panel.



### Attention

The diskette may not be write protected.

### Display the authorizations available on drive A:\

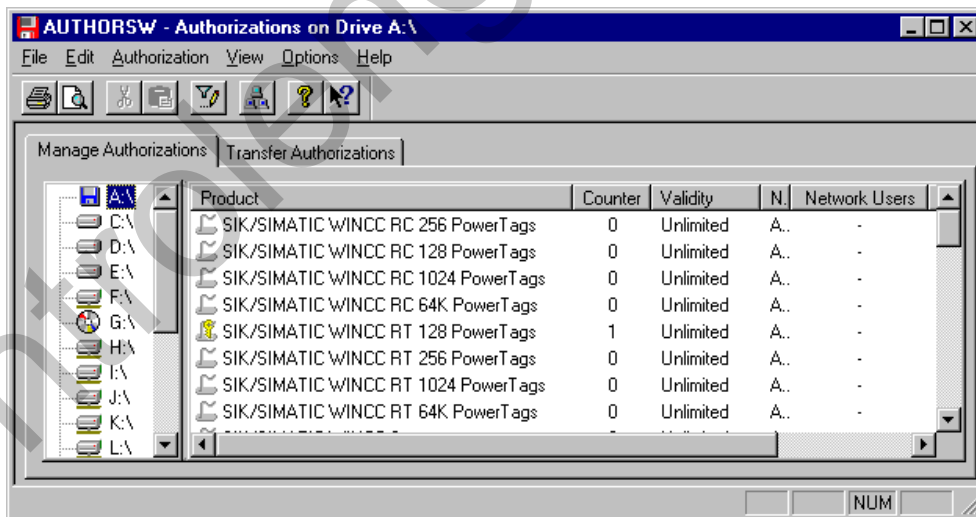

After an authorization is selected, it can be installed from the authorization diskette onto the local drive via the "Transfer Authorization" or via the menu point Authorization/Transfer, where the drive is selected in another mask.

### Transferring the Authorization via the Selection dialog

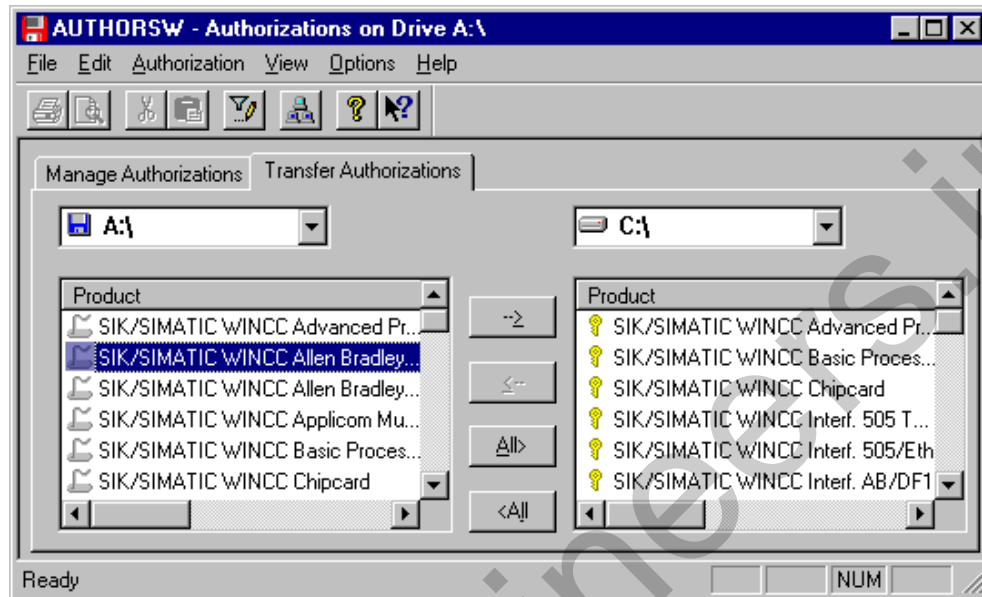

The authorizations can be moved back and forth between the subwindows (selected) using buttons.

In the left subwindow, you will find the original basic set of data objects (source), in the right subwindow, the selected set of data objects (destination).

The transferred authorizations are written in the directory "AX NF ZZ".

## Transferring Authorizations via the Menu Point, Authorization

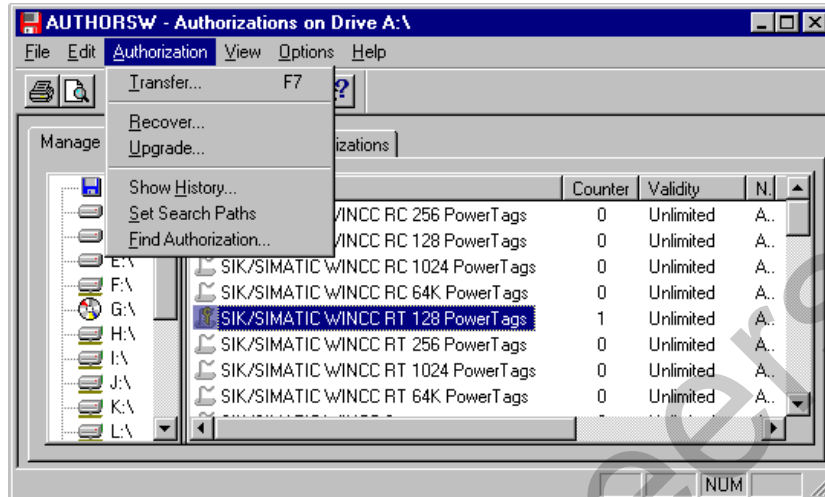

The transferred authorizations are written in the directory "AX NF ZZ".

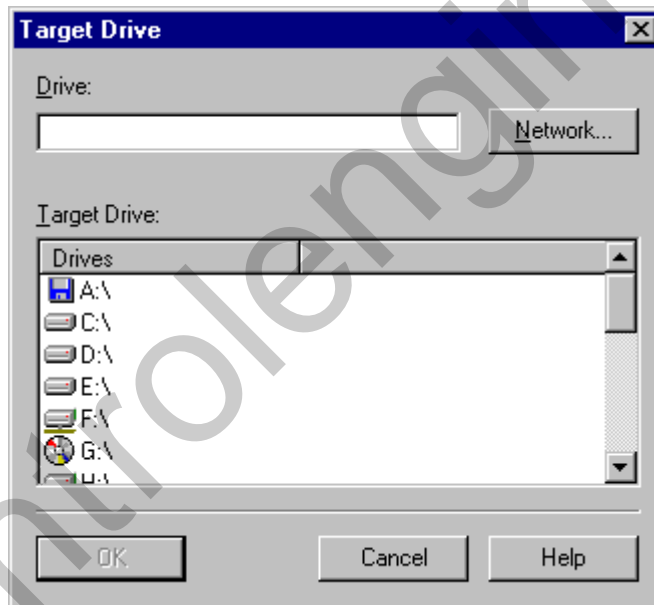

### Note

The authorizations can also be moved by "Drag & Drop".



### Attention

The diskette may not be write protected.



## 1.6 Deinstallation of Authorizations

If an authorization is deinstalled, this means that it will be deactivated on the local drive and reactivated on the diskette (as a rule the multi-authorization diskette) so that the authorization can be used on a different system.

Authorizations are always deinstalled with the "AuthorsW" program.

Display the authorizations available on drive C:\

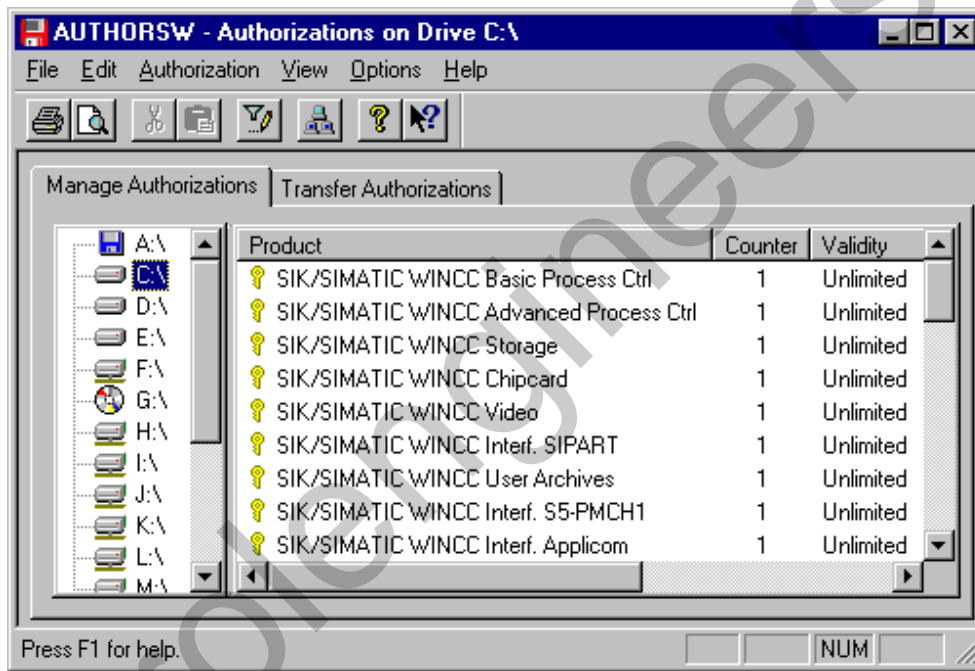

Once an authorization has been selected, it can be deinstalled via the "Transfer Authorization" panel on the source drive or the menu point Authorization / Transfer on an authorization diskette.

### Transferring the Authorization via the Selection dialog

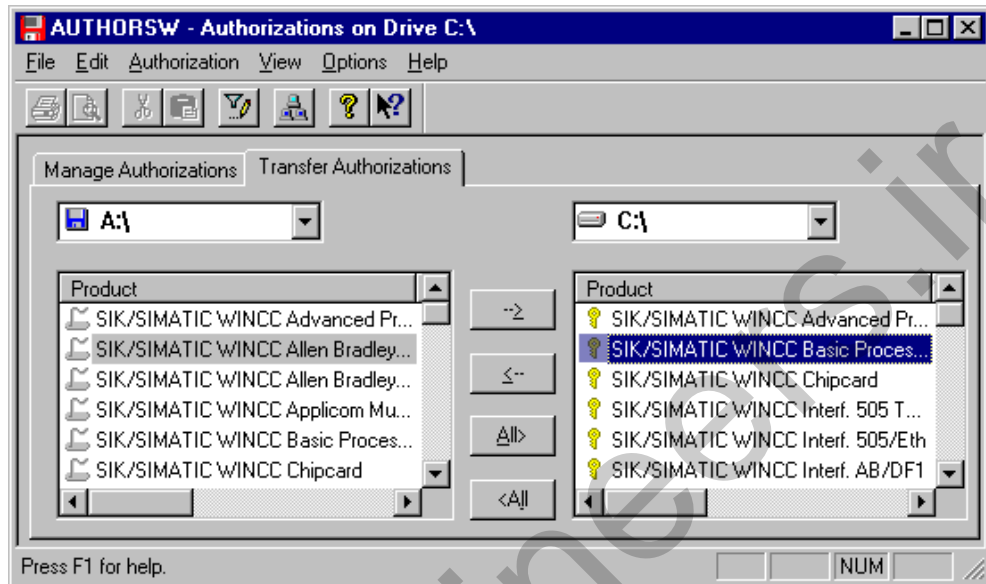

The marked authorizations can be deinstalled with the aid of the buttons on an authorization diskette.

### Transferring the Authorization via the Menu Point

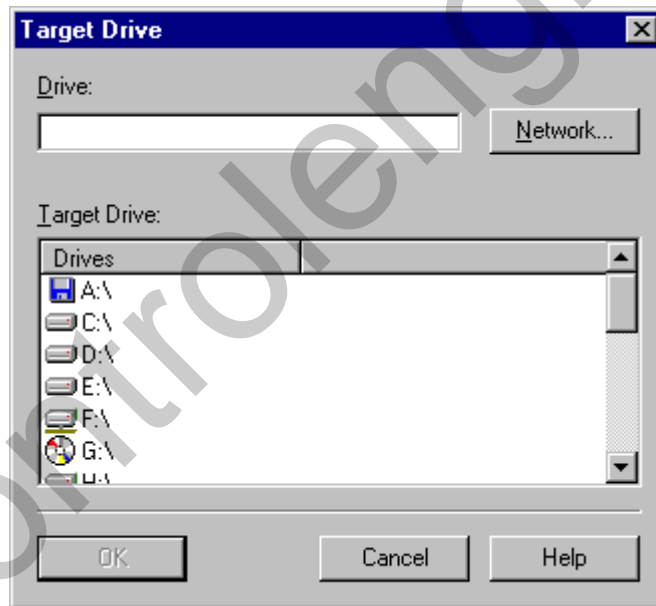
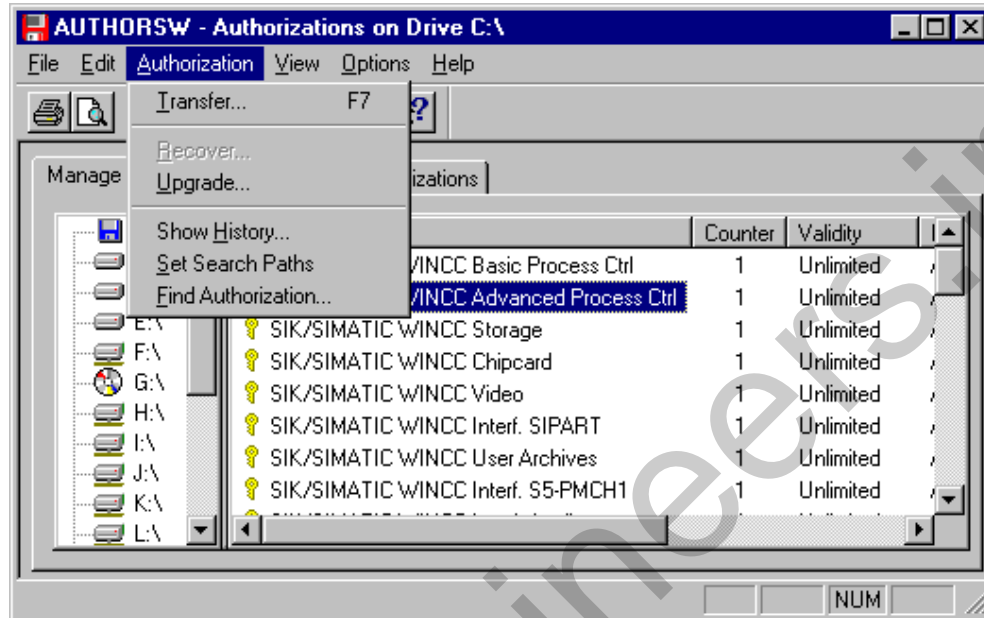

#### Note

The authorizations can also be moved by "Drag & Drop".

## 1.7 Collecting Authorizations on the Multi-Authorization Diskette

The multi-authorization diskette has empty "compartments" to hold authorizations which are found on the single-authorization diskettes. These single-authorizations can be collected on the multi-authorization diskette. In this manner, it is possible to install or deinstall the full set of authorizations, which belong to a WinCC software configuration, and thus make the process of transferring these to another system easier.

The collection of these authorizations is made by way of first installing the single-authorizations from the single-authorization diskettes onto the hard disk and then deinstalling these onto the multi-authorization diskette. Both operations are performed with the handling program, AuthorsW.

---

### Note

This does not apply for the emergency authorization.

---

### Transferring the Single-Authorizations onto the Hard Disk

- Transferring authorizations from single-authorization diskettes onto the hard disk (see Installing Authorizations).
- This process must be repeated for each single-authorization diskette.

### Transferring the Collected Authorizations onto the Multi-Authorization Diskette

- Mark the authorizations collected on the hard disk e.g. with the menu point Edit/Select All or via the Transfer Authorizations panel with the All button.
- Transferring the Authorizations onto the Multi-Authorization Diskette.

All the authorizations that are transferred onto the multi-authorization diskette will be marked there with a "1" in the Counter column and can now be installed on another system.

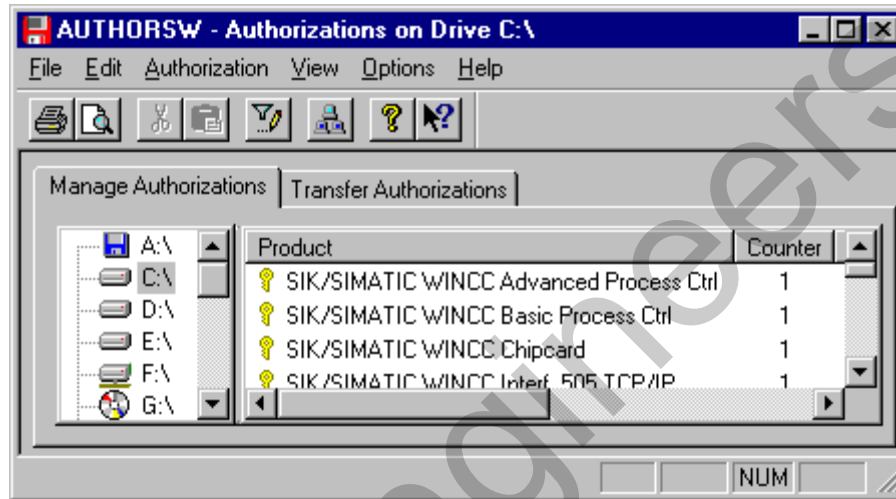

## 1.8 Diagnosing Authorization Problems

If WinCC still switches to demo mode, in spite of the installation of the authorization, you can examine the Licence.log diagnosis file and use the CCAuthorInformation program to help troubleshoot the problem.

### 1.8.1 Licence.log

The Licence.Log diagnostics file is found in the WinCC/Diagnostics path, which is automatically created when installing WinCC.



Licence.Log lists the authorizations called.

```

License.Log - Notepad
File Edit Search Help
07/19/99 14:40:05 InitLicense CS | AppName = AppCS:Mcp | CycleCheck = yes |
NameForMessageBox = | Name of License = A9WRT?3? |
| Text of License = Simatic WinCC RT (Runtime) |

```

#### Note

If the authorization is missing for an option that is used, WinCC will switch to the demo mode.

## 1.8.2 CCAuthorInformation

The program, CCAuthorInformation, is located in the WinCC/bin path. The program provides detailed information about missing licenses.

The WinCC Authorization Information window provides you with information regarding which licenses or upgrades must still be installed, in order to use WinCC without restrictions.

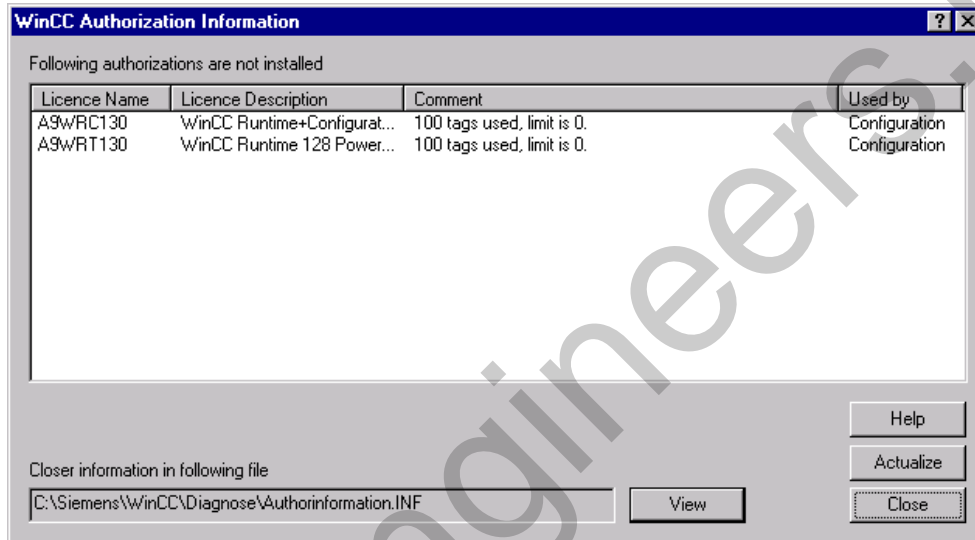

An overview of all WinCC licenses is presented when you open the Authorinformation.INF diagnostic file.

## 2 Upgrading

### 2.1 Upgrading the Number of Tags

The permissible number of PowerTags is increased with the aid of an upgrade program. The corresponding program must be started to control upgrade procedure for the Powerpack.

You will need the following:

- Upgrading RT/RC authorization
- Powerpack diskette with upgrade authorization and upgrade program

---

#### Note

The respective upgrade program is found on the single-authorization diskette delivered with the Powerpack.

---

- Deinstalling the upgrade authorization, when the authorization is not on the computer that should be upgraded.
- Insert the Powerpack authorization diskette
- Start handling program, AuthorsW, via Start in the taskbar
- Select the menu point Authorization/Upgrade
- Start the upgrade program, Update\*.exe, on the authorization diskette
- Insert the multi-authorization diskette (the updating authorization will, if not yet present, be copied to the multi-authorization diskette and made invalid)
- Insert the Powerpack authorization diskette again
- Continue the upgrade process
- Transfer the updated authorization to the local drive



## 2.2 Upgrading the WinCC System

From the Windows Start menu, start AuthorsW and select the menu point Authorization/Upgrading.

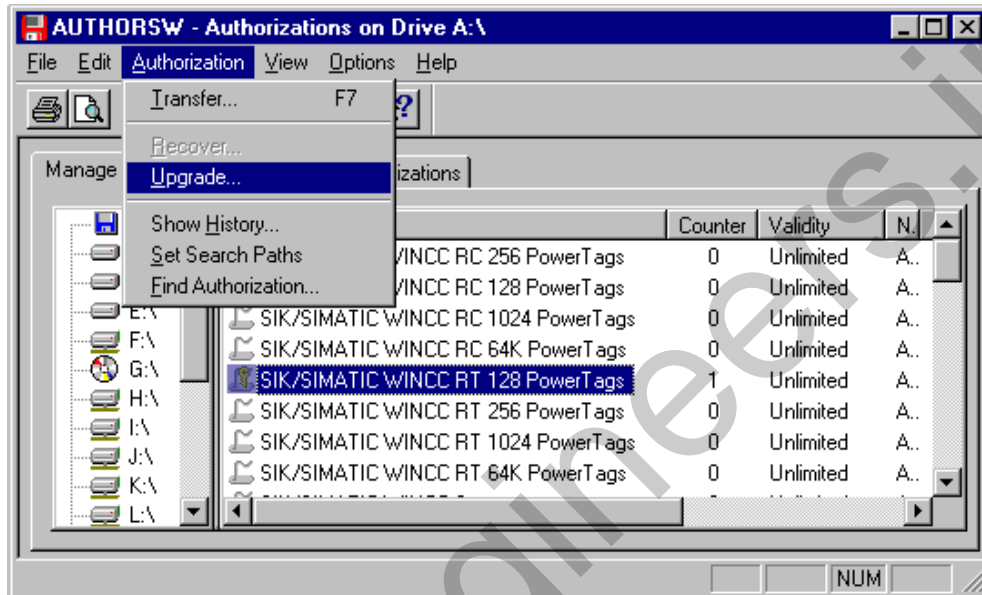

In the next dialog, select and start the upgrade program, which controls the upgrade procedure. It is found on the authorization diskette, which will be automatically requested.

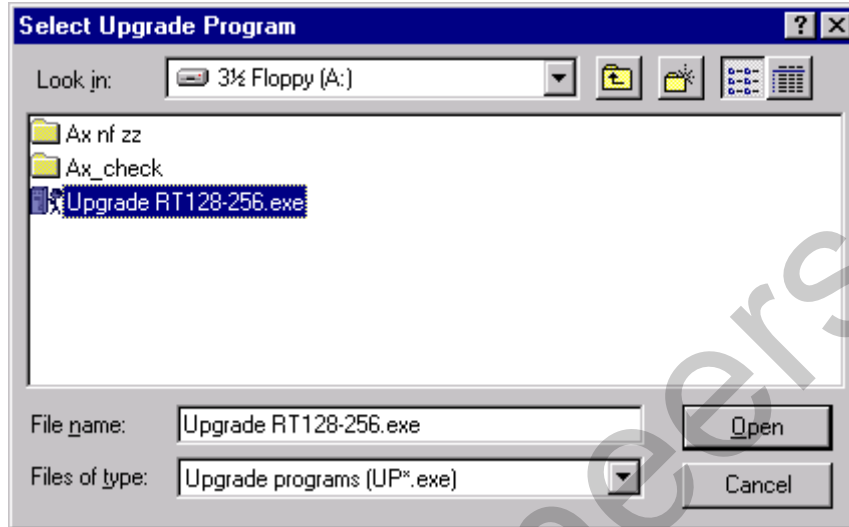

#### Note

The Powerpack authorization diskette has only the required upgrade program.

In order to invalidate the authorization being upgraded, or to first transfer it onto the multi-authorization diskette, you must insert the multi-authorization diskette in the next step.

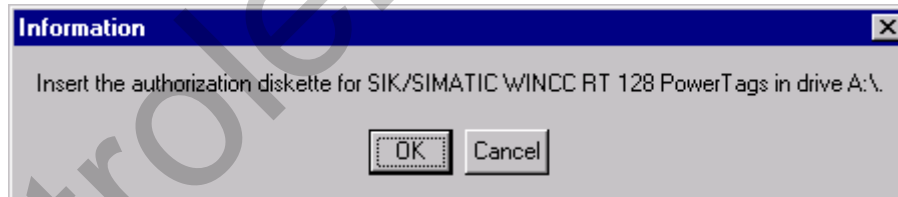

If the authorization is still on the local drive, it must be transferred onto the multi-authorization diskette. To proceed with the upgrade process, confirm this mask with OK.



In the last step, the Powerpack authorization diskette will be required again. The upgrade procedure is finished once the upgrade authorization is transferred onto the local drive.



After the authorization procedure is completed, an upgraded authorization is on the local drive.

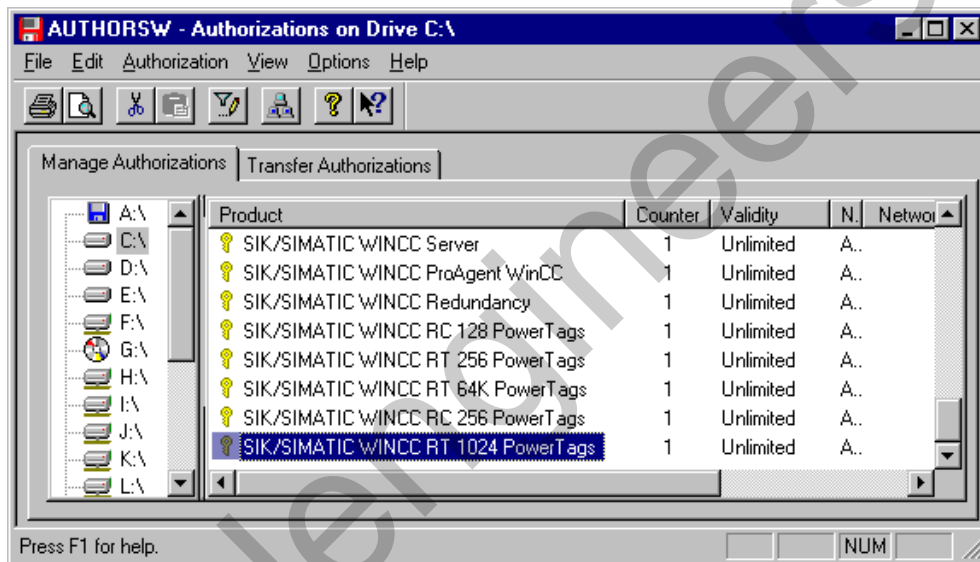

### 3 Repairing Authorizations

An authorization is defective, when it is no longer accessible on the hard disk and therefore cannot be removed by the handling program, AuthorsW.

---

#### Note

In most cases, Customer Support can assist you by phone to "repair" the authorization.

---

#### Relevant Customer Data

First, gather the following information (Customer Support requires the data to quickly repair your system):

- Company data (Name, Address, Country, Telephone/Fax...)
- Order number of the product (e.g. "6AV...") and the product name in clear text.
- Serial number (ID-Number KHE) on every authorization diskette but can also be read with AuthorsW.
- Have information about the type of diskette drive at hand.
- Describe the steps, which led to the loss of the authorization.

### 3.1 Repairing a Defective Authorization

- Please call Customer Support and give them your customer data.
- Put the Multi-Authorization diskette, which held the now lost authorization, in diskette drive A:\ and start the handling program AuthorsW from the Windows Start menu.

Once an authorization on the the Multi-Authorization diskette has been selected, it can be "repaired" with the aid of Customer Support via the menu point Authorization / Restore.

#### Restoring the Authorization

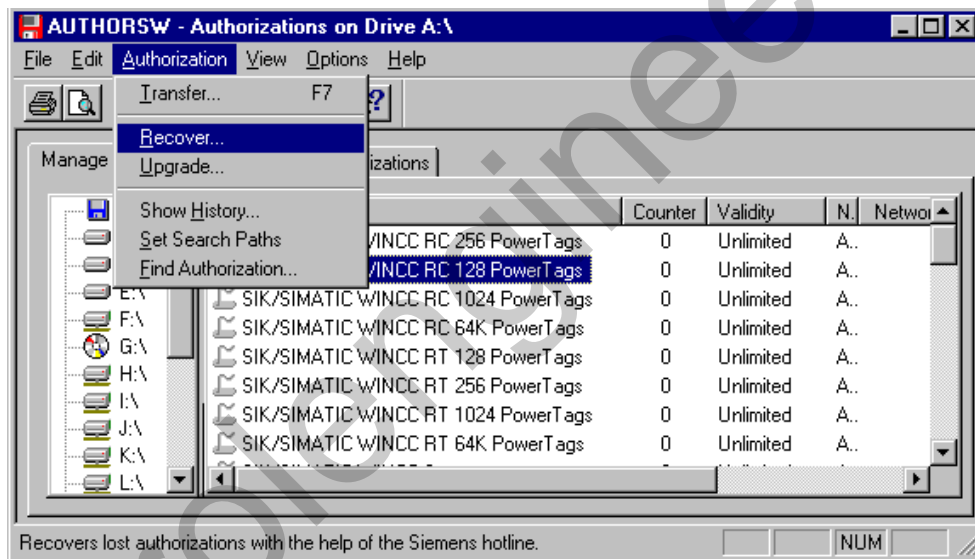

A 6-place numerical request code will be displayed for the selected authorization. Give Customer Support the request code of the lost authorization.

Customer Support will give you a 12-place numerical key code. Enter this code in the entry field.

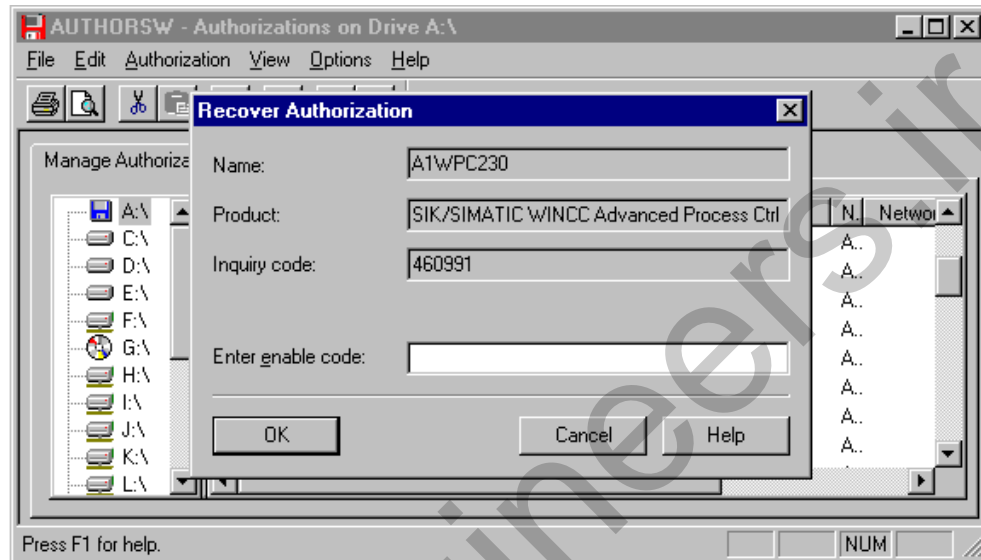

The defective authorization on your multi-authorization diskette will be again enabled (counter = 1) and can be installed on a local drive.



#### Attention

It is not possible to repair a defective authorization directly on the local hard disk.

If several authorizations were lost, the process must be repeated.

### 3.2 Repair Is Not Possible

If it is not possible to repair the access to the authorization diskette by phone, the emergency authorization can be used for up to 14 days. In the meantime, Customer Support will arrange the exchange of the authorization diskette.

### 3.3 Contacting Customer Support

Before contacting Customer Support,

- read the README.TXT file
- have your company data, order number, serial number (ID-Number KHE) ready.
- The file, FaxFormX.wri, on the authorization diskette is available in English, French or German open the appropriate one, fill it out and fax it to one of the addresses below.
- Printout the License.log file.

For more assistance with authorization, please call Customer Support. The following are the responsible centers:

Europe / Africa: Telephone:+49/(911)895-7200 Fax:-7201

Asia / Australia:Telephone:+65/740-7000 Fax: -7141

America :Telephone:+1/423-461-2522 Fax:-2289

Under the Internet address [http://www.ad.siemens.de/support/html\\_00/index.shtml](http://www.ad.siemens.de/support/html_00/index.shtml), you will find the Customer Support homepage. The newest handling program for authorization is always available under Software General in the Downloads section.

### 3.4 Authorization Diskette Labels

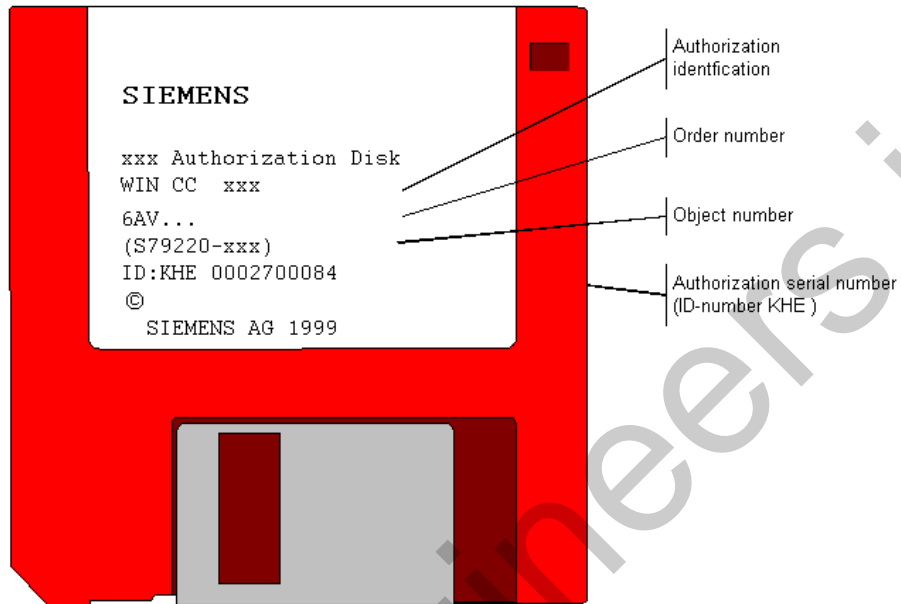

Single-Authorization Diskettes are RED

Multi-Authorization Diskettes / Emergency-Authorization Diskettes are YELLOW





controlengineers.ir

## Index

### A

Authorization .....	1
AuthorsW .....	1, 9
Deinstallation .....	15
Demo Mode .....	6
Emergency Authorization .....	4, 6
Emergency Authorization Diskette .....	1
Full Authorization .....	4
Installation .....	9
Missing licenses .....	20
Multi-Authorization Diskette .....	1
Powerpack .....	4, 24
PowerTag .....	4, 24
Preventing Malfunctions .....	1
Repairing a Defective Authorization .....	28
Restoring the Authorization .....	28
Single-Authorization Diskette .....	1
Upgrade .....	4, 24
Upgrading the Number of Tags .....	4, 24
AuthorsW .....	1

### D

Deinstallation	
Autorisierung .....	15

### E

Emergency Authorization Diskette .....	1
--	---

### F

Full Authorization .....	4
--------------------------	---

### I

Installation	
Autorisierung .....	9

### M

Multi-Authorization Diskette .....	1, 18
------------------------------------	-------

### P

Powerpack .....	4, 24
PowerTag .....	4, 24

### S

Single-Authorization Diskette .....	1
-------------------------------------	---

### U

Upgrade-Authorization .....	4, 24
-----------------------------	-------

controlengineers.ir

## SIMATIC HMI

## WinCC

Manual  
Volume 1 / 2

### Volume 1

Preface	1
System Overview	2
Authorization	3
WinCC Explorer	4
Channels	5
Report Designer	6
User Administrator	7

### Volume 2

Graphics Designer	8
Alarm Logging	9
Tag Logging	10
Text Library	11
Global Script	12
Cross Reference	13

This manual is part of the documentation package with the order number: 6AV6392-1XA05-0AB0

Edition August 1999

WinCC®, SIMATIC®, SIMATIC NET®, SINEC® and STEP® are Siemens registered trademarks.

All other product and system names in this manual are (registered) trademarks of their respective owners and must be treated accordingly.

(The reproduction, transmission or use of this document or its contents is not permitted without express written authority. Offenders will be liable for damages. All rights, including rights created by patent grant or registration of a utility model or design, are reserved.)

(We have checked the contents of this manual for agreement with the hardware and software described. Since deviations cannot be precluded entirely, we cannot guarantee full agreement. However, the data in this manual are reviewed regularly and any necessary corrections included in subsequent editions. Suggestions for improvement are welcomed.)

© Siemens AG 1994 - 1999 All rights reserved

Technical data subject to change

C79000-G8276-C159

Printed in the Federal Republic of Germany

Siemens Aktiengesellschaft

# Table of Contents

<b>1</b>	<b>WinCC Explorer .....</b>	<b>1-1</b>
<b>2</b>	<b>Structure of the WinCC Explorer:.....</b>	<b>2-1</b>
2.1	Menu description .....	2-1
2.1.1	File Menu.....	2-3
2.1.2	Edit Menu .....	2-7
2.1.3	Editors Menu .....	2-8
2.1.4	Tools Menu.....	2-8
2.1.5	Toolbar .....	2-12
2.1.6	Status Bar.....	2-12
2.1.7	Project Navigation Window .....	2-13
2.1.8	Data Window .....	2-14
2.2	Find Function in the Pop-up Menu .....	2-15
<b>3</b>	<b>Project Structure.....</b>	<b>3-1</b>
3.1	General Information About Projects .....	3-1
3.2	Structure of the "Computer" Project Component .....	3-2
3.2.1	Properties of the "Computer" Project Component.....	3-2
3.2.2	"General" Tab .....	3-3
3.2.3	"Startup" Tab .....	3-5
3.2.4	"Parameters" Tab .....	3-9
3.2.5	"Graphics Runtime" Tab.....	3-11
3.3	"Tag Management" Project Component.....	3-19
3.4	WinCC Explorer Editors .....	3-21
3.5	Project Properties.....	3-23
<b>4</b>	<b>Tag Management.....</b>	<b>4-1</b>
4.1	General Information About Tags .....	4-1
4.2	Internal Tags.....	4-5
4.2.1	"Tag Properties" Dialog .....	4-5
4.2.2	Internal Tags in a Tag Group .....	4-9
4.3	Process Tags.....	4-10
4.3.1	"Tag Properties" Dialog .....	4-11
4.3.2	Process Tags in a Tag Group .....	4-16
4.3.3	Addressing a Process Tag .....	4-17
4.4	Standard Data Types .....	4-19
4.5	Raw Data Tags.....	4-25
4.6	"Address Properties" Dialog .....	4-26
4.7	"Select Tag" Dialog.....	4-26
4.8	Tag Group .....	4-30
4.8.1	General Information About a Tag Group.....	4-30
4.8.2	Creating a Tag Group in a New Connection .....	4-30
4.8.3	Creating a Tag Group in an Existing Connection.....	4-31
4.8.4	Cutting, Copying, or Deleting Tag Groups .....	4-31
4.8.5	"Properties of tag group" Dialog .....	4-33
4.9	Communications Drivers .....	4-35

4.9.1	General Information About the Communication Drivers.....	4-35
4.9.2	Properties of a Communication Driver .....	4-36
4.9.3	Accepting a New Communication Driver.....	4-37
4.9.4	Deleting a Communication Driver.....	4-37
4.9.5	Channel Unit.....	4-38
4.9.5.1	General Information about a Channel Unit.....	4-38
4.9.5.2	"System parameters" Dialog.....	4-39
4.9.5.3	System Parameters for the "SIMATIC S5 Ethernet Layer 4" Communication Driver .....	4-40
4.9.5.4	"Channel unit properties" Dialog .....	4-42
4.9.6	Connection .....	4-45
4.9.6.1	General Information About a Connection .....	4-45
4.9.6.2	"Connection properties" Dialog .....	4-45
4.9.6.3	Channel-Specific Tab .....	4-48
<b>5</b>	<b>Editors of the WinCC Explorer .....</b>	<b>5-1</b>
5.1	"Alarm Logging" Editor .....	5-1
5.2	"User Administrator" Editor.....	5-1
5.3	"CrossReference" Editor.....	5-1
5.4	"Text Library" Editor.....	5-2
5.5	"Report Designer" Editor .....	5-2
5.6	"Global Script" Editor .....	5-3
5.7	"Tag Logging" Editor.....	5-3
5.8	"Graphics Designer" Editor.....	5-4
5.9	Server Data .....	5-9
5.9.1	General Information.....	5-9
5.9.2	Commands in the pop-up menu of the Server Data function.....	5-9
5.9.2.1	Functions in a server project .....	5-9
5.9.2.2	Functions on Multi-Client.....	5-11
5.9.3	Selecting Message Servers.....	5-17
5.9.4	Selecting Process Tags.....	5-18
5.9.5	Selecting Server Pictures .....	5-19
5.10	DDE-Server .....	5-21
5.10.1	General Information about the DDE-Server .....	5-21
5.10.2	Integrating Tags via DDE .....	5-22
5.10.3	Local DDE-Connection.....	5-22
5.10.4	DDE-Connection via a Network.....	5-24
5.10.5	Special DDE-Connection to Excel.....	5-27
<b>6</b>	<b>Appendix .....</b>	<b>6-1</b>
6.1	Adapting the Formats of Data Types.....	6-1
6.2	Page Layout Used .....	6-1
6.3	Terms/Abbreviations.....	6-1

# 1 WinCC Explorer

## Positioning the WinCC Explorer within the WinCC System:

The WinCC Explorer represents the topmost level within WinCC. All of the modules are started from here.

The WinCC Explorer Manual provides information about the following items:

- Functionality
- Structure
- The standard editors

The functionality of the WinCC Explorer can be described as follows:

The WinCC Explorer contains all the management functions for the entire **WinCC system**. Within the WinCC Explorer, you can configure and start the run-time module.

---

### Note:

If you want to edit or create a project, the run-time module must be inactive. You can find out if the run-time module is active by looking under the "File" - "Activate" menu items.

---

## Task of the Data Manager:

- The data manager provides the process image with tag values. The data manager is a part of the WinCC Explorer. All of the activities of the data manager run in the background.

## Tasks of the WinCC Explorer:

The main tasks of the WinCC Explorer are:

- Complete configuration
- Guided introduction to the configuration (Tutorial)
- Customized assigning, calling, and storing of projects
- Management of projects, including opening, saving, moving, and copying
- Network-capable editing functions for multiple users (client-server environment) on one project. This means there is consistent data management when multiple editors are working on one project.
- Version management (property of each file object)
- Graphic representation of the configuration data
- Control and configuration of the picture hierarchy/system structure, for example, by means of a tree display
- Global Setup settings, for example, language, system/user path setting
- Configuration of user location-specific functions (server properties)
- Creation and editing of cross references
- Project documentation
- Reporting system states
- Destination system setting (project property)
- Switching between run time and configuration
- Test mode/simulation/operation help for configured data, including picture shift, tag simulation, state display, and message creation



### General Description of a WinCC Client-Server Environment:

By means of the integrated client-server functionality in WinCC, multiple users can access the same database of a project at the same time.

### Practical and Theoretical Limits in the Implementation of Client/Server:

Theoretically, due to software-related limitations, WinCC can accommodate a maximum of 64 nodes (63 WinCC clients, 1 WinCC server) in one project.

Actually, however, the type and implementation of the process communication selected for the WinCC server is of great significance for a realistic number of WinCC clients.

The system can be implemented with up to 16 WinCC clients.

### System structure of the WinCC Explorer:

WinCC Explorer

- WinCC Explorer in the WinCC-System
- Graphic interface for configuration under Windows NT
- Data manager
- Provides the process image with tag values in the following manner:
  - cyclically
  - cyclically upon change
  - event-driven one time
- Transmits data which the data manager gets from automation systems in the following ways:
  - *By receiving*
  - *By requesting*
- **Function Modules**
  - Graphic system (Graphics Designer)
  - *Displays and connects the process graphically*
  - Script editing (Global Scripts)
  - *Makes a project dynamic to your specific requirements*
  - Message system (Alarm Logging)
  - *Outputs messages and acknowledgments*
  - Measurement value archiving and editing (Tag Logging)
  - *Edits measurement values and stores them long term*
  - *Edits user-oriented data and stores them long term*
  - Report system (Report Designer)
  - *Reports system states*

The WinCC Explorer makes it possible for you to navigate through the WinCC applications and their data with only a few operations. The WinCC Explorer is similar in appearance and operation to the Explorer in Windows NT.

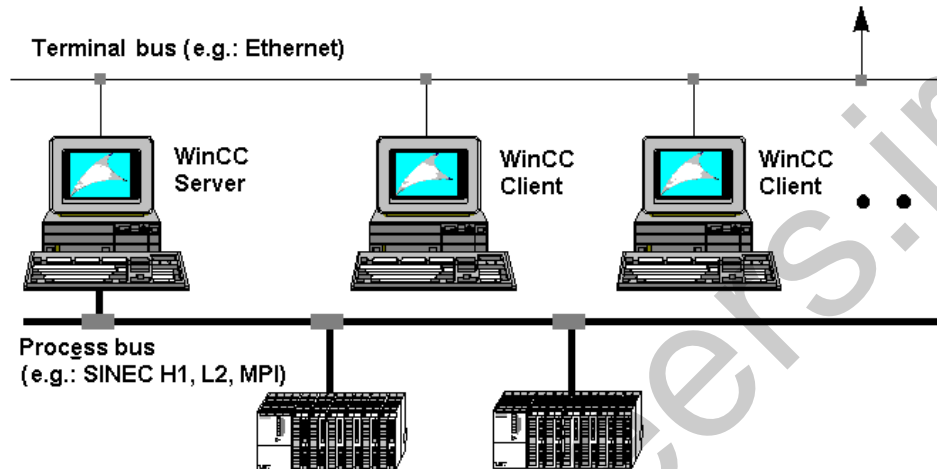

WinCC can be implemented as a multi-user system (client-server structure).

#### General Description of a WinCC Client-Server Installation:

To use the full extent of the functions of a WinCC client-server environment, the following notes are very important:

The WinCC multi-user license must be installed on each server. A runtime license is all that's needed on the clients. In addition, it makes sense to create a project path on the server in which to store all of the WinCC projects. This path (for example, "<DR>:\Projects") should not be on the WinCC program path (separation of data and programs). Experience shows that it is better to store project data on a separate hard disk.

---

#### Note:

You must set the enable and required authorizations for the newly created project path for the users who need to work with the WinCC projects.

---

On the WinCC server, the "aplib" path within the WinCC installation path is generally enabled with the name "SCRIPTFACT". You cannot change the enable command or the enable name. All of the global scripts from action programming (Global Scripts) are loaded on the "aplib" path.

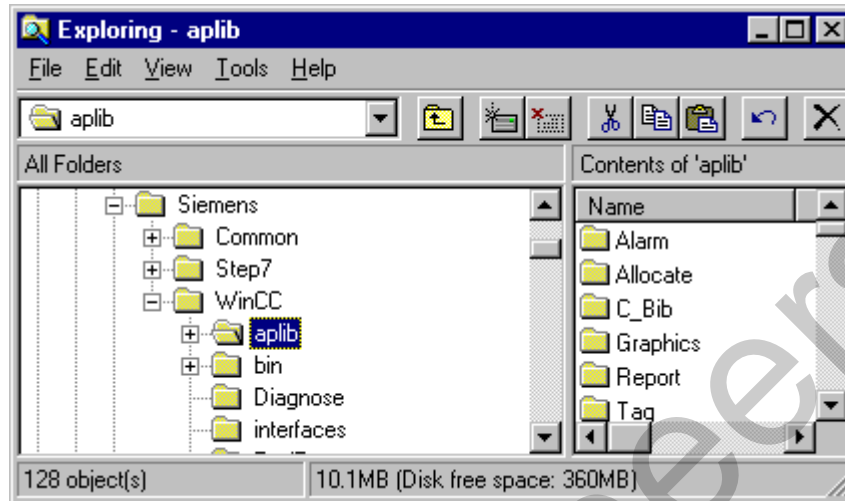

After you install WinCC on the server, start the WinCC Explorer. During the start procedure, the "WinCC Explorer" dialog opens automatically (only the first time you start WinCC).

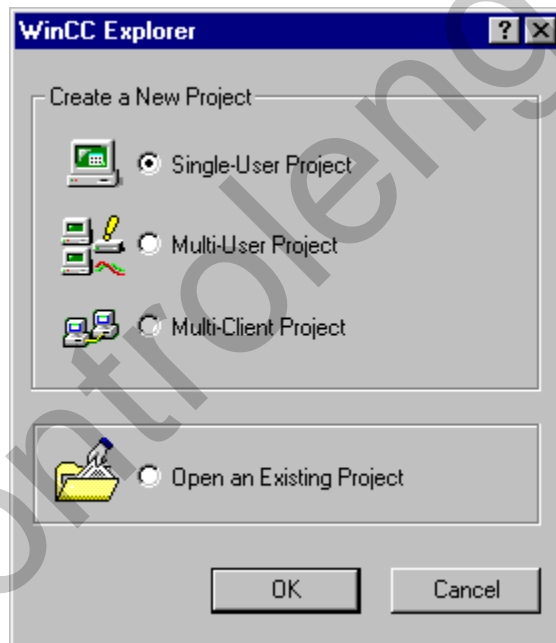

Select "Multi-User System" in this dialog and click the "OK" button. In the "Create a new project" dialog that then appears, set the storage location for the project data. In the "Project Path" box, activate the "<DR>:\Projects" path you created. Enter the name of your new project in the "Project Name" box. The entry in the "Project Name" box is updated at the same time in the "New Subfolder" box. To finish, click the "Create" button to have WinCC create a new path with all of the required project data under the path that you selected.

**Note:**

If you want to change the project type of an existing project, use the Project Properties ("General" tab).

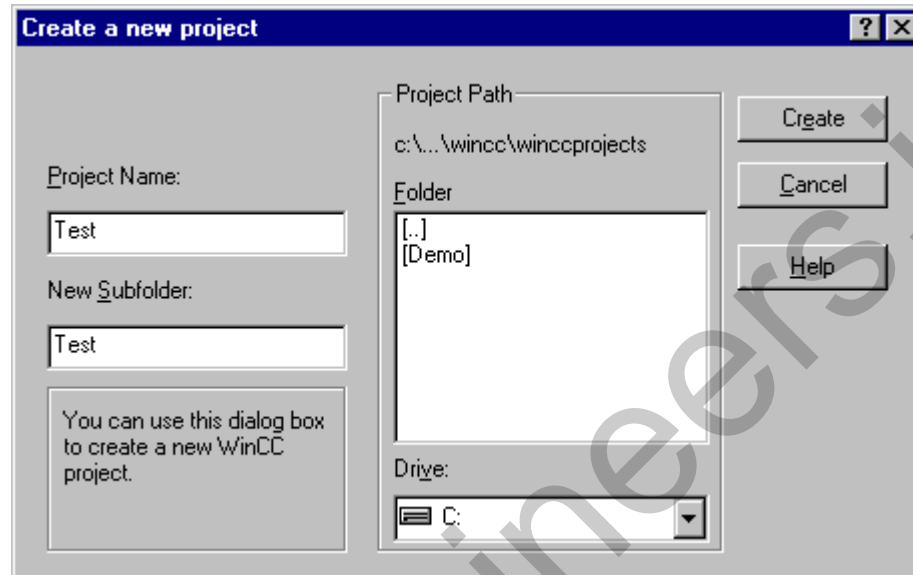

After the project data have been created, the WinCC Explorer opens up with the new project file. You can adapt this project file to your own special requirements.

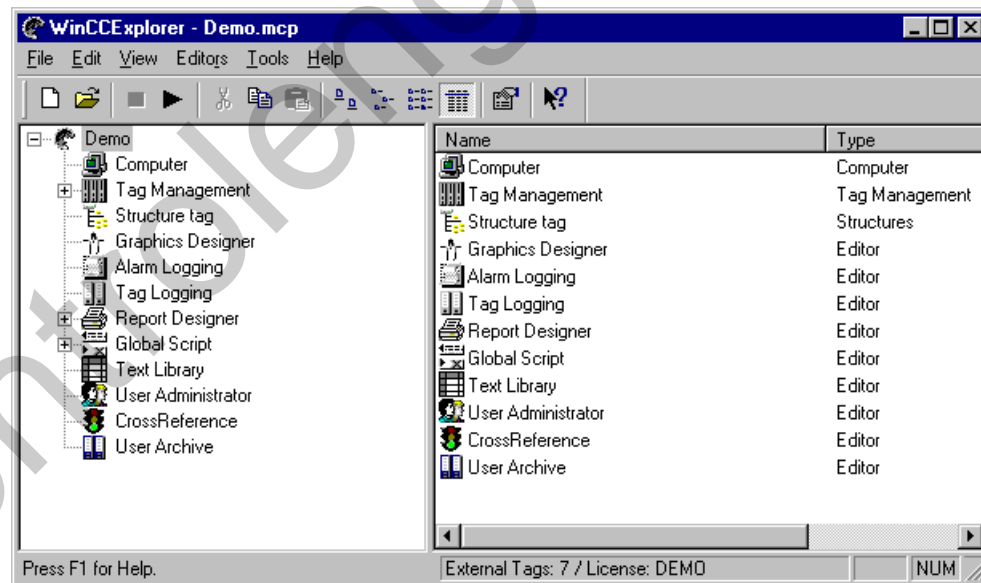

controlengineers.ir

## 2 Structure of the WinCC Explorer:

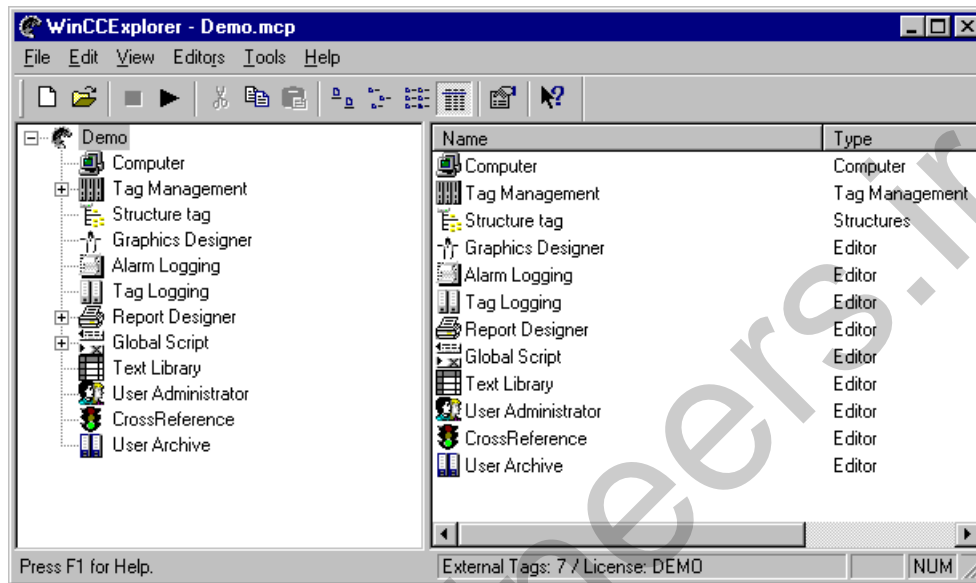

### 2.1 Menu description

The Menu Bar contains all of the commands available in the configuration system of the WinCC Explorer. These commands are arranged in groups and assigned to different menus. To execute a command, open the appropriate menu, click on the command and, if a dialog opens, enter the required parameters.

Menu	Menu Command	Shortcut
File	New	Ctrl + N
	Open...	Ctrl + O
	Close	
	Activate	Ctrl + S
	Print Project Documentation	
	Preview Project Documentation	
	Project Documentation Setup	
	Exit	
	Shut Down...	
Edit	Undo	Ctrl + Z
	Cut	Ctrl + X
	Copy	Ctrl + C
	Paste	Ctrl + V
	Delete	DEL
	Properties	

Menu	Menu Command	Shortcut
View	Toolbar Status Bar Large Icons Small Icons List Details Update	F5
Editors	Graphics Designer Alarm Logging Tag Logging Report Designer Global Script Text Library User Administrator Picture Tree Manager Lifebeat Monitoring Time Synchronization	
Tools	Language Status of Driver Connections Status of Multi-User Operation Import/Export Variable	
?	Contents and Index Direct Help Using Help Tutorial About WinCC Explorer...	

**Note:**

The explanations presented below only refer to those menu commands that will not already be familiar to you from other Windows applications or whose functional scope goes beyond that familiar. Information about these menu commands can be found in the QuickTips for the individual editors.

## 2.1.1 File Menu

### New

Use the "New" menu item to open a dialog in which you can open a new project.

#### How to Create a New Project:

1. In the Toolbar, click on the  icon  
or  
Click on "New" in the "File" menu.  
or  
Use the key combination "Ctrl + N."
2. You have the following three options when creating a new project.
  - Single-User Project
  - Multi-User Project with Server Utilities
  - Multi-Client Project
3. You can also open an existing project.
  - Open an Existing Project

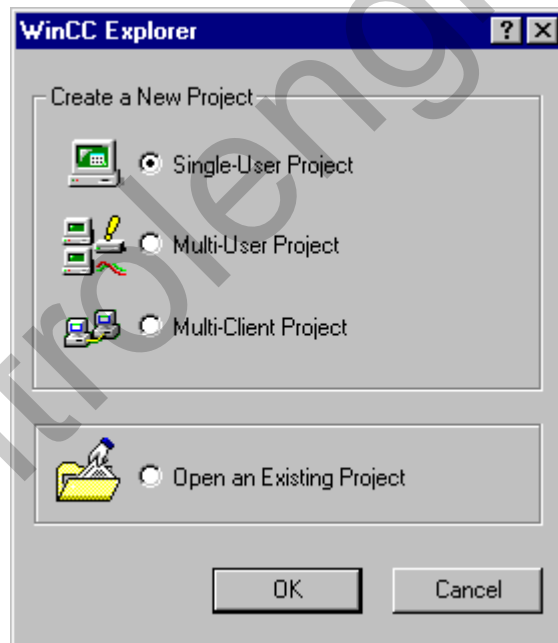

This example shows you the dialog for creating a new project.

4. Click on "OK".
5. This selection opens a window entitled "Create a new project" in which you can enter all of the details required for your new project.



**How to Create a New Project:**

Field	Value/Meaning
Project Name	Enter the name of your new project in this box. The project name is limited to 64 characters; the DriveLetter\Path\ProjectName in total are limited to 255 characters.
New Subfolder	WinCC suggests that you use the same name for "New Subfolder".
Folder	Select the folder in which your "New Subfolder" is to be created.
Project Path	The path under which your project is stored is displayed here.
Drive	Select the drive on which your new project is to be stored.

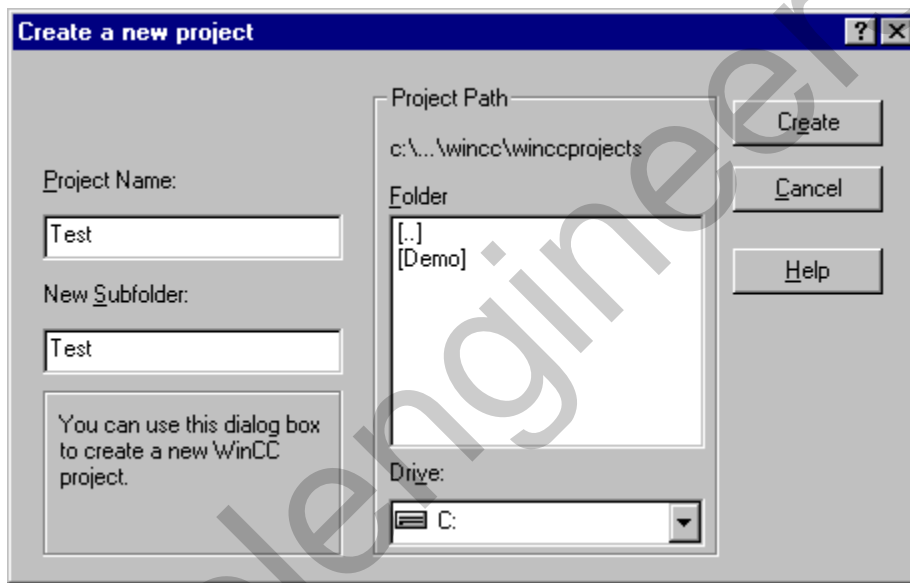

This example shows you the "Create New Project" dialog box.

**How to Map a Network Drive:**

Field	Value/Meaning
Drive	Use this value to link a drive letter to the network drive path.
Path	Here you can enter the path of the enabled folder to which you want to establish a connection. Normally, you have to enter the path in the following format: \\Computername\Foldername
Reinstate connection on startup	This setting enables you to specify that the network drive connection is restored each time the system is restarted. When this setting is active, the corresponding check box indicates the fact.

## Activate

Use the "Activate" menu item to trigger start/stop of the process control (runtime) of the current project. This menu allows you to switch between process control and configuration.

If you activate the runtime-module, this is noted within the "File" menu in the following manner:

- A check mark is in front of the "Activate" menu item
- The name of the current project is identified with the term "Active" within the WinCC Explorer title bar.

---

### Note:



You can also activate/deactivate a project with the aid of the two buttons in the toolbar.

---

### How Can You Start a Configured Picture Automatically When The WinCC Explorer Starts?

If you make the following settings, the runtime module of the WinCC Explorer as well as an existing picture in the Graphics Designer are started automatically each time the WinCC Explorer program is started.

1. Within the "Computer" project computer, activate the Properties of the "Computer" and switch to the "Graphics-Runtime" tab. Enter the desired start picture in the "Start Picture" box.
2. Open the "Startup" tab and activate the "Graphics Runtime" box. This box is active by default.
3. Use the "File" "Activate" menu item to start the runtime module.

---

### Note:

The runtime modules of a computer with an active check box in the "startup list" are started when you activate a project.

---

### Behavior of the WinCC System Following the "Activation" of a Project:

Once you have activated a project, you cannot delete configured tags or connections. If you attempt to, the "Delete an Object" message window appears. This window informs you that you cannot delete an object within an active project.

### Behavior of WinCC While Exiting Runtime:

If you exit the WinCC Explorer while a project is still activated, this project will be activated again the next time you start WinCC. If you press and hold down the key combination <Ctrl> + <Shift> while the WinCC Explorer is being loaded, the project is prevented from being activated and the WinCC Explorer starts in the configuration system.

---

### Note:

The key combination for halting the activation of a project works for a single user system and for the server of a multi-user system, but not for the clients of a multi-user system.

---

**Print Project Documentation**  
**View Project Documentation**  
**Set Up Project Documentation**

Use the "Print Project Documentation" command to print out the current project information on the specified printer. The template used for the printout is the "@MCPCS.RPL" page layout, which can be edited in the "Report Designer". The project documentation contains information about the configured computers, tags and connections.

Use the "View Project Documentation" command to display a preview of the project documentation.

Use the "Set Up Project Documentation" command to specify the printer and the page layout.

---

**Note**

Additional information about printing the project documentation can found in the "Project Documentation" chapter of the system description.

---

**Exit**

Use the "Exit" menu item to exit the WinCC Explorer. This command closes all of the files of the open project.

**How to Exit a Project:**

From the menu bar, select "File" and then "Exit". In the following dialog box you have the option to either "Exit WinCC Explorer and Close Project" or "Exit WinCC Explorer". After making a selection, click on "OK" for confirmation. All project related files will be closed. If you made unsaved changes in this application, a dialog box will prompt you to either save or ignore the changes before exiting.

**End WinCC Explorer and close the Project**

If you select this option, the WinCC Explorer will be ended and the active project be closed. If WinCC is started again, the project loaded the last time will be opened.

**End WinCC Explorer**

If you select this option, the WinCC Explorer will be ended. However, other applications will still have access to the current WinCC project. If WinCC is started again, the project loaded the last time will be opened.

## Shut Down

Use the "Shut Down..." menu item to exit the WinCC Explorer and shut down Windows NT or log on under another name.

- Shut down Windows.
- Shut down Windows and restart.
- Log off and log on under a different name.

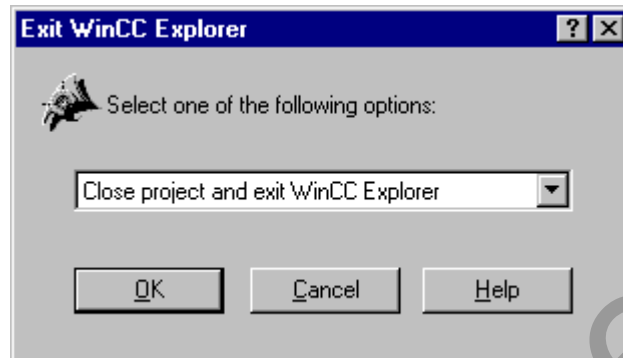

This is the Shutdown window of the WinCC Explorer.

### How to Exit a Project and the Current Windows Session:

Select "File" "Shut Down..." from the menu bar. In the dialog that then appears, select the option you want to use for exiting WinCC. When you then click on the "OK" button, all of the project-related files close and the system shuts down or switches to another state from which a different user can log on.

## 2.1.2 Edit Menu

### Properties

Use the "Properties" menu item to edit the contents of the properties of the current object.

### How to Edit the Properties of the Current Object:

Click on "Properties" in the "Edit" menu.

or

click on the  icon in the Toolbar.

or

open the pop-up menu by clicking the right mouse button and select the "Properties" menu item.

### 2.1.3 Editors Menu

Use this menu item to add additional menu items during runtime as long as this is supported by the DLL of the application.

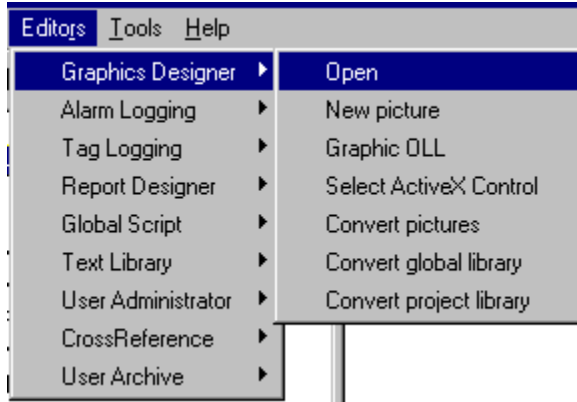

This example shows you the currently connected editors. The application DLLs of the editors support this connection capability by means of the "Editors" menu item.

#### Selecting and Activating Menu Items Under "Editors":

1. Click on "Editors" in the menu bar.
2. Select a menu item.
3. From the submenu that opens, select the menu item you want to activate.

---

#### Note:

Every menu item within the "Editors" menu contains the option "Open". Some of the menu items also contain other options. The available menu items correspond to the structure of the pop-up menu for each individual editor which is located in the Project Navigation Window.

---

### 2.1.4 Tools Menu

#### Language

Use the "Tools" "Language" menu item to make a global language setting for the entire WinCC system. This language setting affects the system messages, menu items, and on-line help.

---

#### Note:

This menu item is available only if you installed more than one language when you installed WinCC. Generally, WinCC provides the following three languages:

German, English, French

---

### How to Activate a Specific Language:

1. Click on "Tools" in the menu bar.
2. Then select the "Language" menu item.
3. In the "Language" dialog, you can select the language with which you want to work from the list of installed languages. To do this, simply select the desired language and then click the "OK" button. This action activates the selected language.

### Status of Driver Connections

Use the "Status of Driver Connections" menu item to view current information about the runtime module.

#### Note:

In order to see the current runtime status, the runtime module must be activated. Use the "Activate" menu item in the "File" menu to determine whether the runtime module is active.

### How to Scan the Current Runtime Status:

Click on "Status of Driver Connections" in the "Tools" menu. This action opens the "Status - Logical Connections" window. The current logical connections and their current status are displayed in seven columns in this window.

Column	Meaning
Name	Name of the logical connection.
Status	Status of the logical connection.
Error	Number of errors which occurred in the logical connection.
Tag read	Total number of tags read in the logical connection since the start of the project.
Tag written	Total number of tags written in the logical connection since the start of the project.
Read requests	Number of read requests of the logical connection still open. If there are no read requests, there is a 0 at this location. Any other number value shows you that there are read requests that have not been concluded. Each activated read request increases the counter by 1. If the read request is completed, the number is decreased by one.
Write requests	Number of write requests of the logical connection still open. If there are no write requests, there is a 0 at this location. Any other number value shows you that there are write requests that have not been concluded. Each activated write request increases the counter by 1. If the write request is completed, the number is decreased by 1.

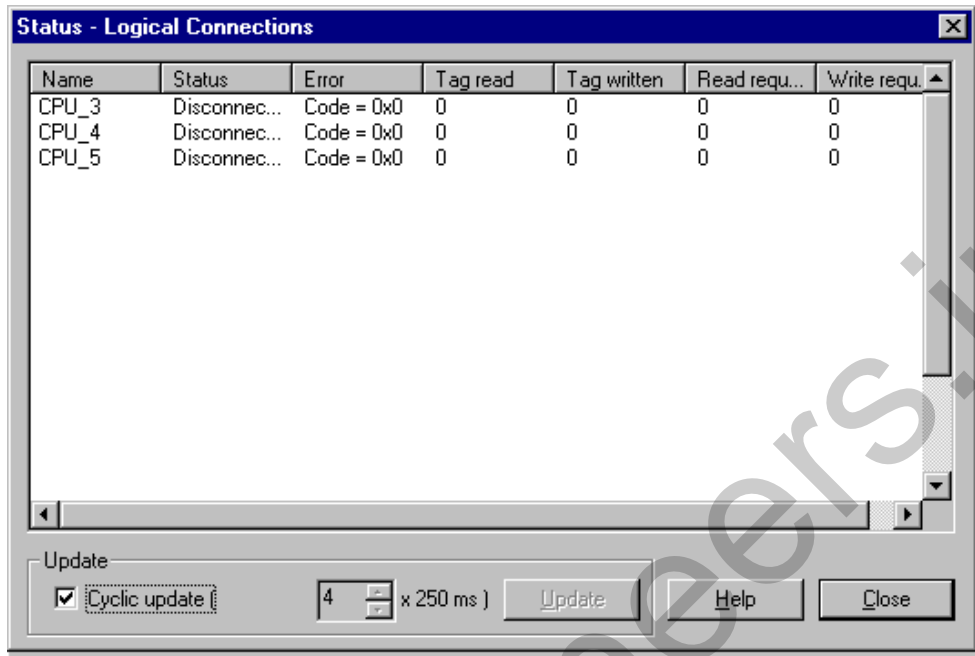

This is the "Status - Logical Connections" window. Within this window, the seven columns provide an overview of the current status.

**How to Influence Updating of the Runtime Status:**

Area Name	Meaning
Update	
Cyclic update	<p>Activates cyclic updating. The cycle interval is executed in steps of 250 ms. The standard value for the update is 1 s (4 x 250 ms).</p> <p>Use the up-down controls  to adjust the time interval. You can enter a value between 4 and 99 in the text box.</p>
Update	<p>Up you do not select a cyclic update, you can use the "Update" button to execute a current update of all of the connections.</p>

**Status of Multi-User Operation**

Use the "Status of Multi-User Operation" menu item to view the current status of multi-user operation. This shows you, for example, which computers are currently accessing the project. The dialog box is divided into the following two tabs:

- Process Data Server
- Process Data Clients

**Note:**

The boxes in the individual tabs can NOT be edited. In case of an error, the information here is very helpful for the WinCC hotline.

The status of a multi-user system can also be viewed from the clients, but only the information pertaining to the client making the request will be displayed.

The "Process Data Server" tab provides the following information:

Box Name	Meaning
Network Protocols Supported	This list box contains all of the available network protocols.
UUID	This abbreviation stands for Universal User Identification. A unique identifier for the entire project is displayed in this box.
Network-Endpoint	The network endpoint is assigned dynamically by the operating system.
Properties	This box displays two values that are separated by a slash and have the following significance: the first value is the minimum number of threads that are running and the second value is the maximum number of threads that are running on the server.

The "Process Data Clients" tab provides the following information about a special client. You can select the client by means of the drop-down list box.

Box Name	Meaning
UUID	This abbreviation stands for Universal User Identification. A unique identifier for the entire project is displayed in this box.
Network Protocol	This box displays the protocol that the client is using to communicate with the server.
Network Address	This box displays the 12-digit Ethernet address of the server network card to which a connection was made.
Network-Endpoint	The network endpoint is assigned dynamically by the operating system.













**Note:**

If you view the status of the multi-user system from a client, all the information pertaining to this client will be displayed. Information about the server and other clients can not be viewed.



## 2.1.5 Toolbar

These icons make it possible for you to carry out actions more quickly. You do not need to select your way through the menu until you reach the required function.

Icon	Description
	"File" "New"
	"File" "Open ..."
	"File" "Deactivate"
	"File" "Activate"
	"Edit" "Cut"
	"Edit" "Copy"
	"Edit" "Paste"
	"View" "Large Icons"
	"View" "Small Icons"
	"View" "List"
	"View" "Details"
	"Edit" "Properties"
	"Help" "Find ..."

## 2.1.6 Status Bar

Use the "View" "Status Bar" menu item to display/hide the status bar. The status bar is displayed in the lower margin of the WinCC Explorer main window. Displayed on the left side is general information about the current project, while indicated on the right side is the keyboard status.

Box Name	Meaning
Number of tags configured	The number of external tags configured is displayed here.
Number of power tags	The number of tags covered by a license is displayed here.
CAPS	Caps Lock is active.
NUM	The numeric keypad, located on the right side of the keyboard, is active.
SCRL	Scroll Lock is active.

## 2.1.7 Project Navigation Window

### The Project Navigation Window:

The Project Navigation Window is located on the left side of the WinCC Explorer and contains the project components, for example: "Computer", "Tag Management" etc.

1. There is a main node in the project navigation window that is represented by the project name.
2. A project consists of the following components:

Project Component	Meaning
Computer	All of the workstations and servers that are assigned to a project are managed in this area.
Tag Management	All channels, logical connections, process and internal tags, and tag groups are managed in this area.
Structure tag	Serve to combine standard data types in a new data structure. These data types form a logical unit.
Editor	This includes the graphic system (Graphics Designer), action (script) processing (Global Scripts), the message system (Alarm Logging), measurement value archiving and editing (Tag Logging), the report system (Report Designer), user authorization (User Administration), and the text library (Text Library). These modules are all a part of the WinCC system but they do not all have to be installed. The optional editors can also be installed, namely Lifebeat Monitoring, Base Data and Time Synchronization.

#### Note:

You can edit the properties of the project components "Computer" and "Tag Management" by opening the pop-up menu and selecting the "Properties" option. The project component "Computer" contains additional sub-items.

### You Can Move As Follows in the Project Navigation Window:

1. In the project navigation window, click on the plus or minus signs to open or close additional levels.
2. Double-click on a name in order to open or close an additional level (for example, double-click on "Computer" to open the next level).

#### Note:

You can use the mouse or the keyboard to move in the project navigation window. Keyboard commands correspond to those used in Windows NT (for example. arrow keys, plus and minus on the numeric keypad). Each change in position triggers an immediate update of the data window on the right side of the screen.

## 2.1.8 Data Window

### The Data Window:

The contents of the Data Window change depending on the component selected in the Project Navigation Window. The Data Window is located on the right side of the WinCC Explorer and contains, for example, internal tags, new structure, print job.

Column	Meaning
Name	This column displays the name of the object, a tag or a file. (The file name is assigned to a specific editor).
Type	This column displays the type of the object: for example, in the case of a computer, this column could contain "Server". With tags, the data type of each tag is displayed.
Command Line Parameter	This column displays the address descriptions for external tags: for example, the data block number (DB) and the data word address (DW). In the case of internal tags, "Internal Tags" is entered in this location.
Last Change	This column displays the date and time of the last change.

---

#### Note:

Use the "Name," "Type," "Parameters," and "Last change" buttons to sort the contents of the data window in ascending or descending order.

---

## 2.2 Find Function in the Pop-up Menu

You can set the start of the search (Find function) in the Project Navigation Window. Select the point from which the search starts. This way you can limit the search result.

### How to Find Objects or Tags:

#### Note:

This help tool is offered in all of the pop-up menus of the WinCC Explorer.

1. In the Project Navigation Window, click the right mouse button on a list or an object, or click on an empty space in the Data Window.
2. In the pop-up menu that then appears, click on the "Find" menu item.

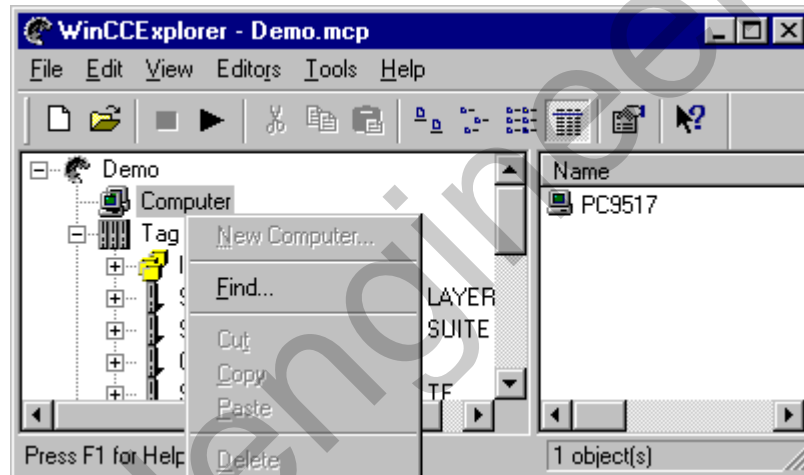

3. In the window that then appears, you can enter your search conditions in one of several tabs.

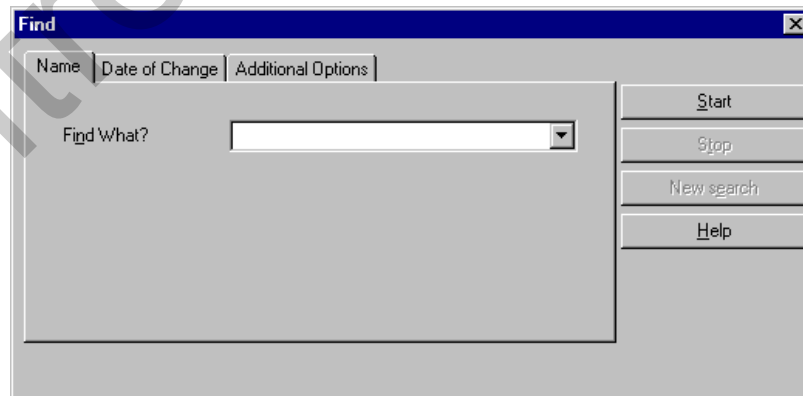

Tab	Meaning
Name	Enter the term you want to find.
Date of Change	Enter the date of change to further limit the search conditions for the objects.
Additional Options	You can limit the search conditions even further in this tab.

4. Once you have entered the name of the object you are searching for, click the "Start" or "New search" button. This selection activates the find function.

## 3 Project Structure

### 3.1 General Information About Projects

#### What are Project Components and Where Are They Located?

A project consists of the following components:

- Computer
- Tag Management
- Editors

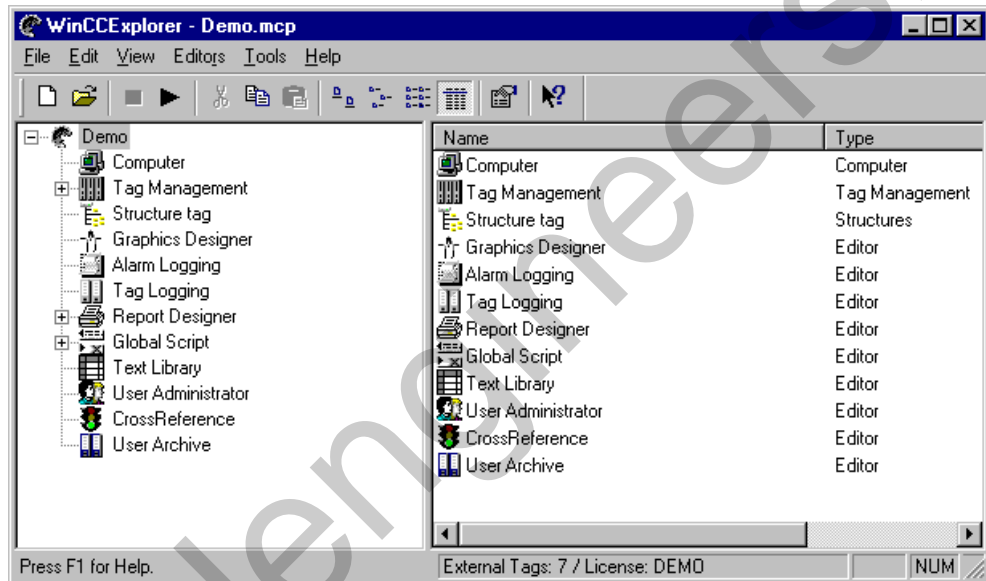

The Project Navigation Window lists all of the components that belong to the project.

## 3.2 Structure of the "Computer" Project Component

### The "Computer" Project Component Has the Following Structure:

There are no sub-items to this component. All of the computers assigned to the project are listed in the Data Window.

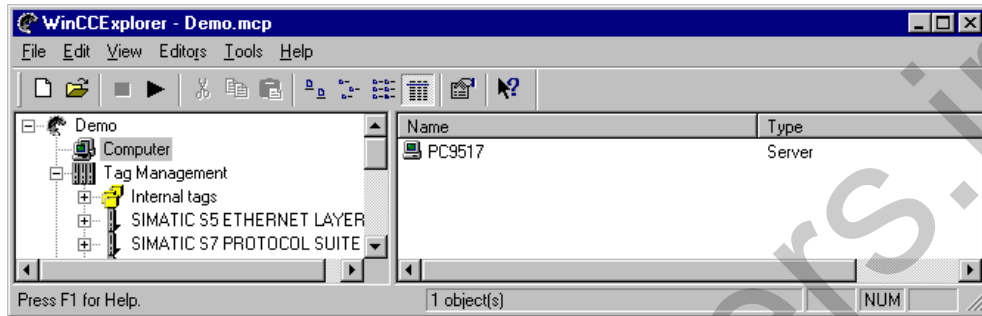

This example shows you a configured computer of type "Server" under the project component "Computer".

### 3.2.1 Properties of the "Computer" Project Component

#### How to Edit the Properties of the "Computer" Project Component:

1. In the Project Navigation Window, click the right mouse button on "Computer". In the pop-up menu that then appears, select the "Properties" menu item.
2. In the "Computer list properties" dialog, you can start the following actions:
  - Use the "Delete" button to delete the selected computer from your current project management. In order to be able to edit a project, at least one computer must be available.
  - Use the "Properties" button to edit the properties of the selected computer.

Use the "Computer properties" dialog to specify the computers involved in the project. Only control stations that are included in the configured computer list of the project can switch to runtime mode as well as configure.

Use the "Startup", "Parameters" and "Graphics-Runtime" tabs to define the startup behaviour of runtime for the local computer. For example, you can define the language to be used in runtime, the start picture to be used, the window attributes, the keyboard assignments and the behaviour of cursor control.

### 3.2.2 "General" Tab

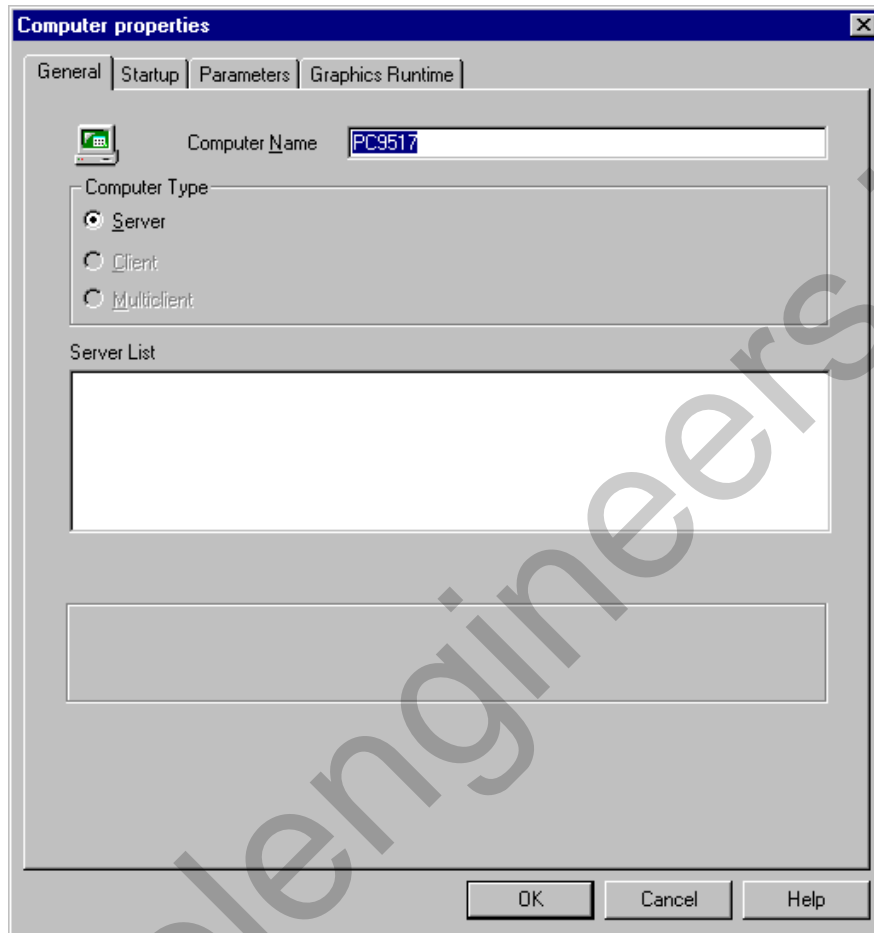

#### Input Box "Computer Name"

How to Edit the "Computer Name" Input Box:

Click on the "*Computer Name*" box and enter the name of the computer that is to have access to the WinCC system.

---

#### Note:

You can determine which computers are accessible over the network by using the Windows Explorer. All of the current computers are listed in the "Network Environment" node.

---





### Selection Box "Computer Type"

Use this selection box to assign a specific function within the current project to the selected computer.

Area Name	Meaning
Server	Central computer for data storage and global management of the WinCC system.
Client	A "Client" is also known as a workstation. The WinCC Explorer is loaded locally on each of these computers.
Engineering Station	This computer serves in a purely monitoring capacity. No projects can be edited on this computer.

#### How to Edit the Selection Box:

Simply click on the relevant selection box and activate or deactivate it.

#### Note:

If a server already exists and you click on the "Server" selection box for a configured client computer, the "Select Process Data Server" message window appears. This window notifies you that a server exists. If you click "OK" in the message window, the selected client computer is changed to a server and the current server (the name of the server is in the message window) changes to a client. This change does not take effect until after you restart WinCC.

### List Box "Client-Server List"

This list box displays all of the configured client and server computers. Depending on whether you select the client or server computer type, the title of the list box changes to the following:

- Client "Name of the server"
- Server "Names of clients"

#### List Box "Name of the server":

Sets the location of the data source (project database) for each client.

#### List Box "Names of clients":

The client list displays the clients that have access to the server and to the data source (project database) available there.

#### Meaning of the Buttons of the List Boxes:

Select a server in the server list and edit the list using the following buttons:

- Use the "Up" and "Down" buttons to change the sequence of the servers in the server list.
- Use the "Properties" button to edit the properties of the selected computer.
- Use the "Add" button to add a new computer to the current list.
- Use the "Delete" button to delete a computer from the current list.

### 3.2.3 "Startup" Tab

You can enter programs in the "Startup" tab that are to be loaded automatically when the WinCC Explorer starts.

You can activate the default WinCC runtime modules or include programs from other manufacturers.

The following two window areas within the "Startup" tab are arranged above and below each other:

1. Sequence When Starting the WinCC Runtime Module  
This window contains a list of all of the default WinCC runtime modules.
2. Additional Tasks/Applications  
The applications that are not in the "Sequence When Starting the WinCC Runtime Module" window but must still be started are managed in this window.

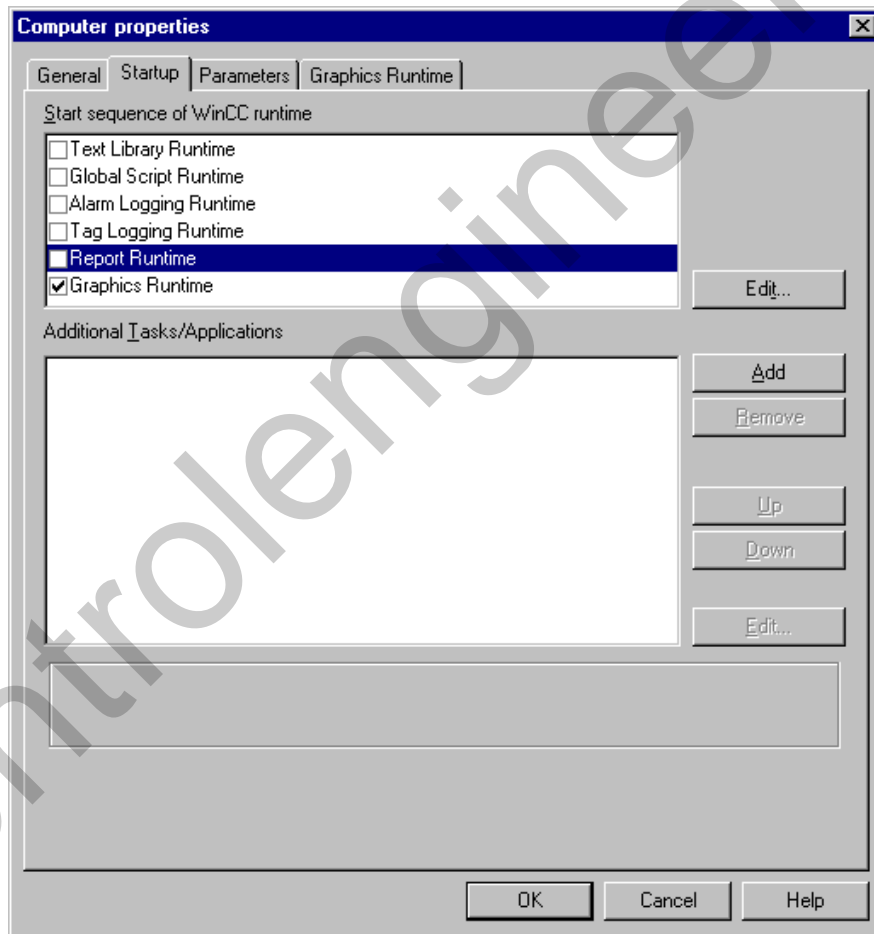

#### Note:

When you create a new project, only the Graphics Runtime is activated in the startup list. Printing out a hardcopy by means of the hot keys only functions if the program PrtScr.exe has been started beforehand. Hardcopies can then be printed out both during configuration and WinCC runtime. If you add the PrtScr.exe program to the startup list, WinCC will then start PrtScr.exe when the runtime system runs up.

## Sequence When Starting the WinCC Runtime Module

This window lists all of the default WinCC runtime modules. You cannot delete any of the available modules in this list box. You can only activate or deactivate these modules. When you activate a module, the selected module is loaded automatically when the WinCC system starts. As a default, all of the modules are activated and started automatically.

### How to Activate/Deactivate a Specific Runtime Module:

You must click on the box in front of the module name to activate or deactivate the runtime module.

### How to Assign an Optional Parameter to a Specific Runtime Module:

In the list box, select a WinCC runtime module. Click on the "Edit..." button to open the "Edit Application Parameter" dialog. You can edit the "Command Line Parameter" input field in this dialog.

---

#### Note:

In the "Edit Application Parameter" dialog, you can only edit the "Command Line Parameter" input field.

---

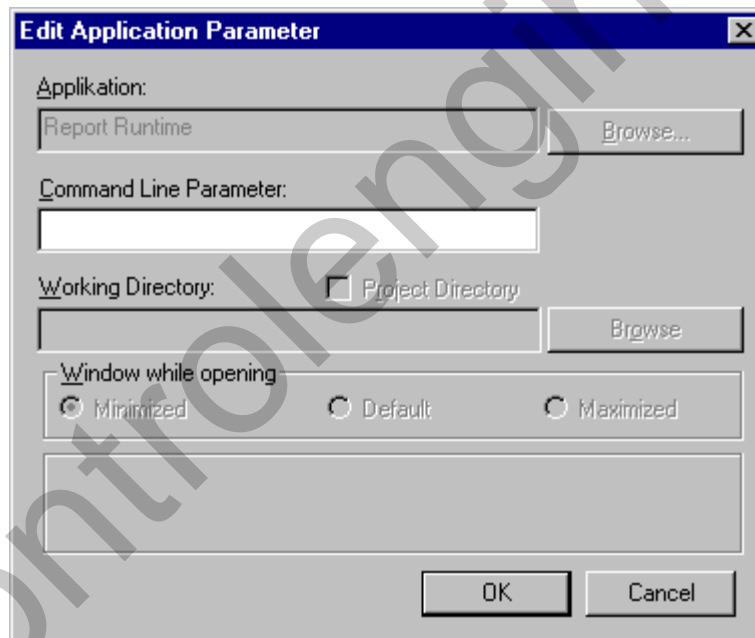

This example shows you that the "Command Line Parameter" field is the only area that can be changed for the "Report Runtime" module.

### Additional Tasks/Applications

The applications that are not available in the "Start sequence of WinCC runtime" field but still have to be started are managed in the "Add Application" window which you open by clicking the "Add" button.

#### Structure of the Selection Window:

In this dialog, you can enter the required settings for the applications you want to add.

The input fields in this dialog have the following meaning:

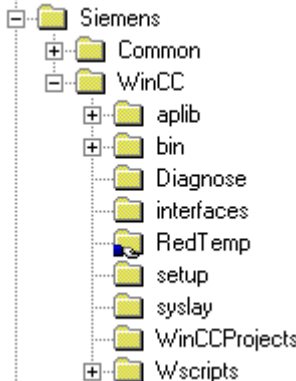
Area Name	Meaning
Application	Enter the exact name of the desired application in this input field. You must also input the exact path for this application. The simplest way to enter a new application is to use the "Browse..." button. After you click on the "Browse..." button, the "Find file" dialog opens. By default, this dialog searches in the path in which you have installed the WinCC system (for example, C:\WinCC\Bin). You should enter executable programs in this field. You can recognize such programs by their *.EXE, *.COM, or *.BAT file extensions. <b>Note:</b> If you do not make any entries in this field and then click the "OK" button, an error message window appears.
Command Line Parameter	Use this input field to enter the required parameters of the application. You can determine which parameters can be entered here by looking in the manual for the corresponding application.
Working Directory	Use this input field to set the working directory in which all of the files necessary for the application are located. The simplest way to enter a working directory in this input field is to use the "Browse" button. After you click on the "Browse" button, the "Working directory" dialog opens in which you can search for the required working directory and transfer it to the "Working Directory" input field.
Project Directory	Click on the "Project Directory" check box to set the current project directory as the working directory. Normally, all the project directories are created under the path in which you have installed the WinCC system (e.g.: "<Drive>:\WINCC\BIN\"). The correct syntax for the WinCC Explorer project directory is as follows: "<Drive>:\WINCC\WinCCProjects\<Projectname>"
	 <p>The image shows a file explorer window displaying the directory structure of a WinCC installation. The root folder is 'Siemens', which contains subfolders: 'Common', 'WinCC', 'Diagnose', 'interfaces', 'RedTemp', 'setup', 'syslay', 'WinCCProjects', and 'Wscripts'. The 'WinCC' folder is expanded, showing its contents: 'aplib', 'bin', 'Diagnose', 'interfaces', 'RedTemp', 'setup', 'syslay', 'WinCCProjects', and 'Wscripts'.</p>

Area Name	Meaning
	In this example, the project directory is "<Drive>:\WINCC\WinCCProjects\".
	<b>Note:</b> If you have activated this check box, the "Working Directory" input field and the "Browse" button are grayed and you can no longer use them.
Window while opening	Use this field to set the window size of the application at the start of the program. You can select from the following three settings:
	<b>Minimized:</b> Under Windows NT, this program is displayed as an icon on the screen.
	<b>Default:</b> Under Windows NT, this program is displayed after it starts in the screen mode under which it is runs by default. This value is also the default setting.
	<b>Maximized:</b> Under Windows NT, this program is displayed in full screen view after it starts.

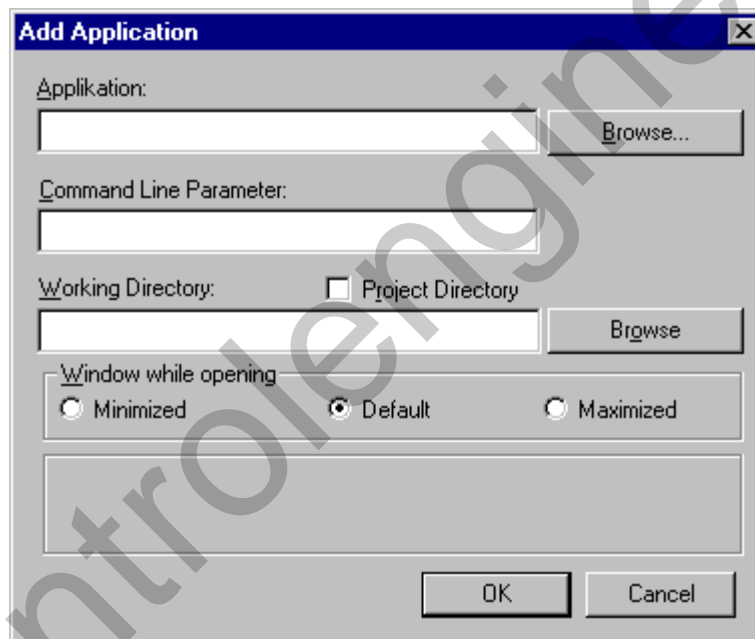

### Editing the "Additional Tasks/Applications" List Box:

Select an application from the list box.

- Use the "Up" and "Down" buttons to set the start sequence of the applications.
- Use the "Add" button to add a new application to the list box.
- Use the "Remove" button to delete a selected application from the list box.
- Use the "Edit..." button to edit the settings of the selected application.

### 3.2.4 "Parameters" Tab

#### You Can Affect the Following "Parameters":

These settings affect the working method of the computer selected:

Field	Meaning
Disable Keys	
Ctrl+Alt+Del	Under Windows NT, you can no longer open the Windows NT security window.
Alt+TAB	You cannot switch to another application.
Ctrl+Esc	Under Windows 95, you can no longer open the Start menu. Under Windows NT, you can no longer open the task list.
Alt+Esc	You cannot switch to another application.
Priority	
Normal	With this setting, the program occupies the processor until a program with a higher priority requests access.
High	With a high priority, the program occupies the processor by itself. Other programs cannot access the processor until the program releases it.
	Language Setting at Run Time
	This location displays the current language setting for configuration of the runtime module.
Start Information	
	Use this field to open a new properties window within the "Parameters" tab. This only functions when the program to be connected does not support any MFC functions. If the connected program supports this possibility, the "Edit" button is enabled for activation.

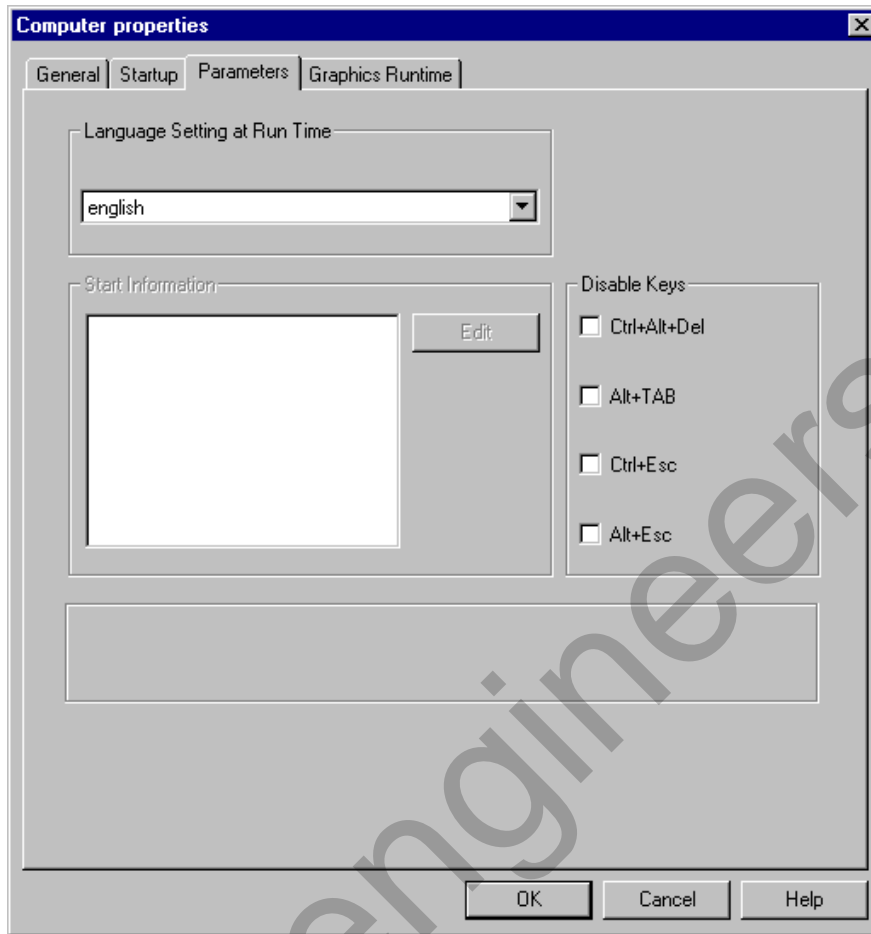

### 3.2.5 "Graphics Runtime" Tab

Use this tab to change the appearance as well as the edit mode for the runtime module.

#### Structure of the "Graphics Runtime" Tab:

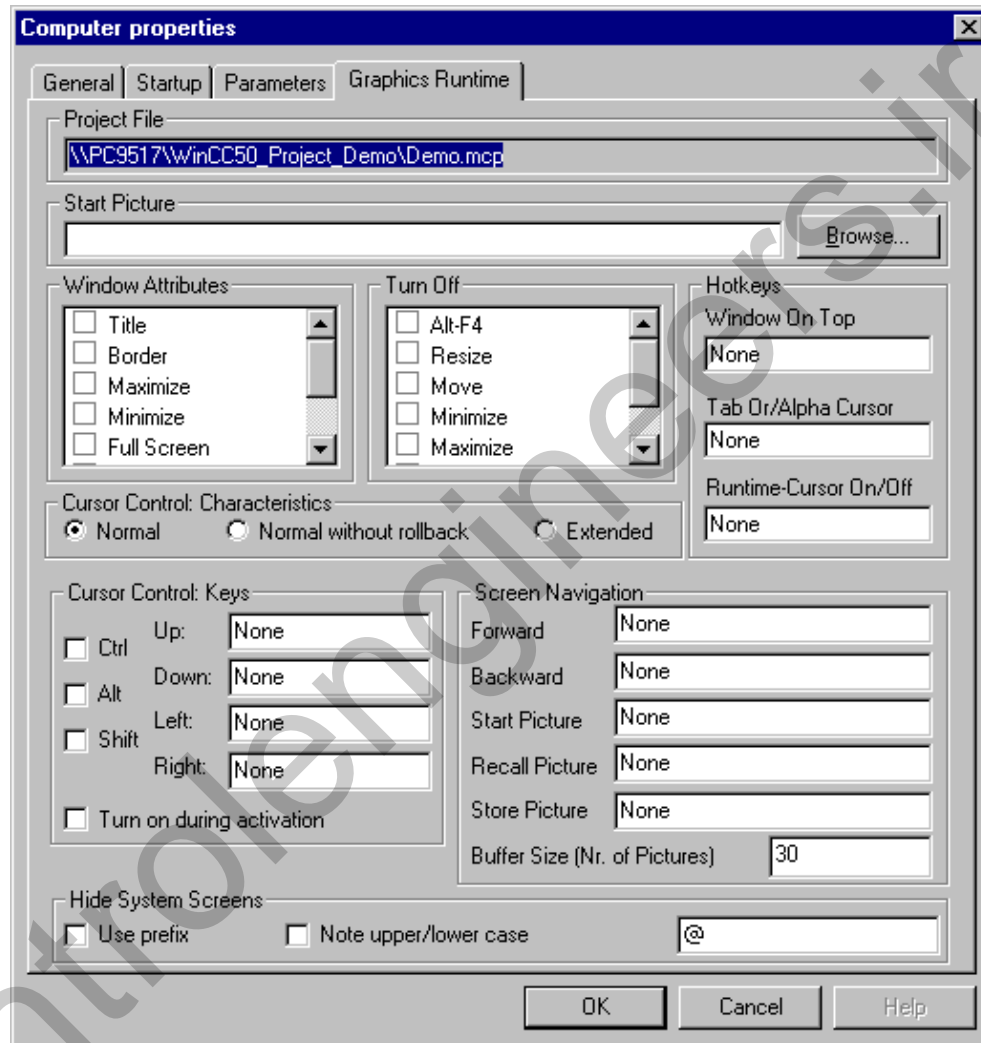

Field	Meaning
Project File	This box displays the name of the current project file.
Start Picture	<p>You can enter the name of the desired start picture either directly or search for a name using the "Browse..." button.</p> <p>You must enter the name of the start picture in the "Start Picture" box without specifying the path. The path of the start picture consists of the project path and "GraCS," for example, "C:\WinCC\Bin\<projectname&gt;\gracs".< p=""> <p>If you use the "Browse..." button to connect a start picture, you must be sure that the start picture is located in the default folder "GraCS".</p> </projectname&gt;\gracs".<></p>



Field	Meaning
Window Attributes	<p>Use the window attribute settings to modify the appearance of the picture window in runtime.</p> <p>You can give the runtime picture windows a title bar, border, scroll bar and status bar. The picture window can also be equipped with buttons for Maximize, Minimize and Full Screen.</p>
Turn Off	<p>Use the turn off settings to modify the appearance of the picture window in runtime.</p> <p>You can turn off the Alt-F4, Resize, Move, Minimize, Close and Optimized Drawing buttons.</p>
Hotkeys	<p>To create a hot key, select the box you want by clicking it. Then use the key or keystroke combination you want to assign to the box. The hot key selected is then displayed as a character string in the box selected, e.g. Tab Order/Alpha Cursor:&lt;Ctrl+S&gt;</p> <p>A hotkey code that has been assigned twice will not be detected by the system, reported or intercepted. You are responsible for managing the character strings used for hotkeys. A double assignment of a hotkey code will cause problems in runtime.</p>
Cursor Control: Characteristics	<p>Use these option buttons to define the movement cycles of the cursor keys.</p>
Cursor Control: Keys	<p>Use these boxes to set the keyboard shortcuts for moving the cursor Up, Down, Left and Right.</p> <p>In order to define the combination of a key with the "Ctrl", "Alt" or "Shift" key for a specific cursor movement, select the relevant check box too. This selection then applies to all four of the cursor movement input fields.</p> <p>Activate the "Turn on during activation" check box to specify that the cursor control keyboard shortcuts defined are to be used each time the runtime system is started.</p>
Screen Navigation	<p>Use these boxes to set the keys or keystroke combinations to be used to navigate round the screen. Then use the key or keystroke combination you want to assign to the box.</p>
Hide System Screens	<p>You can use these check boxes and box to hide the system screens, this making it easier to search for configured pictures in the Graphics Designer.</p>

### Select Window Attributes

Field	Meaning
Titel	Select this box to view the title bar of the window.
Border	Select this box to give the window a border.
Maximize	Select this box to display the button for maximizing the window.
Minimize	Select this box to display the button for minimizing the window.
Full Screen	Select this box to open the window in full screen mode. This mode uses the entire screen for the display.
Scroll Bar	Select this box to equip the window with scroll bars.
Status Bar	Select this box to equip the window with a status bar.
Adapt Picture	Select this box to adapt the configured window structure to the current window size.

### Deselect (Turn Off) Window Attributes

Field	Meaning
Alt-F4	Select this box to deactivate the <Alt> + <F4> hot key for closing the window.
Resize	Select this box to deactivate the ability to use the window border to change the size of the window.
Move	Select this box to make it impossible to move the window.
Minimize	Select this box to deactivate the button for minimizing the window.
Maximize	Select this box to deactivate the button for maximizing the window.
Close	Select this box to deactivate the button for closing the window.
Optimized Drawing	Select this box to turn off the optimized screen structure for the individual elements. This means that the window structure occurs in steps. You can recognize the step-by-step window structure when the affected element flashes. If this box is not active, the window is not updated in steps. This is achieved by displaying the entire contents of the window at once (external screen construction within the RAM and then copied to the video storage).

## Defining Hot Keys

Field	Description
Window On Top	By configuring picture windows within a picture, you can set specific window areas. To switch from one window area to another, define a hot key here.
Tab Order/Alpha Cursor	By configuring within picture windows in the "Graphics Designer" picture, you can group specific areas into a "Tab Order Sequence" or an "Alpha Cursor Sequence". You can define a hot key for switching between the "Tab Order Sequence" and "Alpha Cursor Sequence". All buttons are grouped within a "Tab Order Sequence". All I/O fields are grouped within an "Alpha Cursor Sequence". Depending on which sequence is active, you can use the "Tab" key to move from one box to the next and Shift + TAB to the previous box.
Runtime-Cursor	Use this box to set a hot key to turn the Tab Order or Alpha Cursor sequence that is currently active on or off.

## Characteristics of Cursor Control

Field	Description
Normal	Once the cursor reaches the outer fields of the cursor group, the cursor will jump to the first field within the row in which the cursor has been moved, if you continue to use the cursor key that moves the cursor outwards.
Normal without rollback	Once the cursor reaches the outer fields of the cursor group, it will remain at that position, even if you continue to use the cursor key that moves the cursor outwards.
Extended	You can move the cursor up to the outside positions. Once the cursor reaches the farthest position, the cursor moves to the first position within the next row or column.

**The settings in the "Cursor Control" selection box have the following effect on the behavior of the cursor during runtime:**

"Normal" option button: (default setting)

You can move the cursor up to the outside positions. Once the outermost position has been reached, the cursor will jump to the first position within the current row or column.

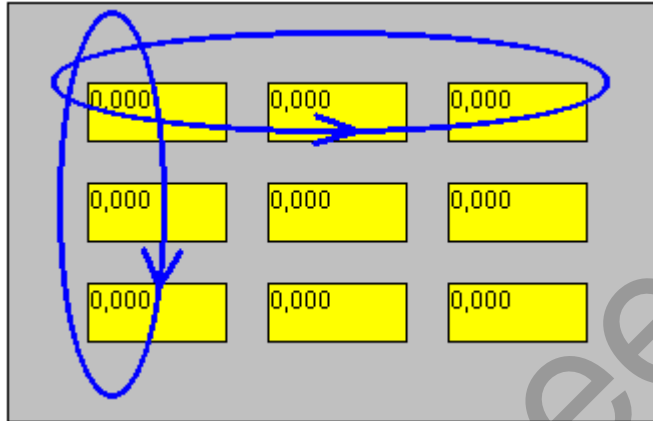

"Normal without rollback" option button:

You can only move the cursor to the outside positions. Once the outside position has been reached, the cursor will remain at that position. The cursor can then be moved only towards the inside.

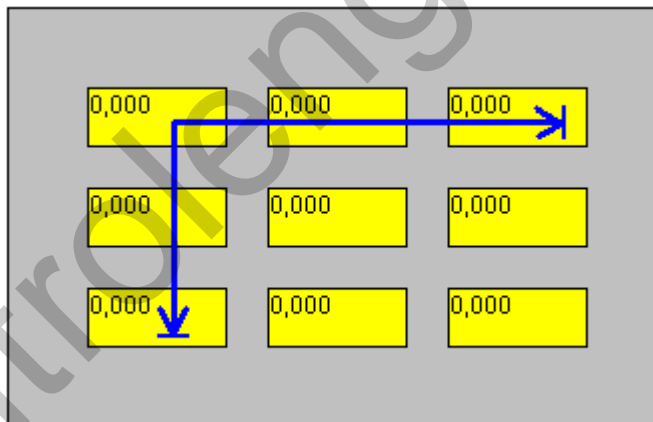

"Extended" option button:

You can move the cursor up to the outside positions. Once the cursor reaches the farthest position, the cursor moves to the first position within the next row or column.

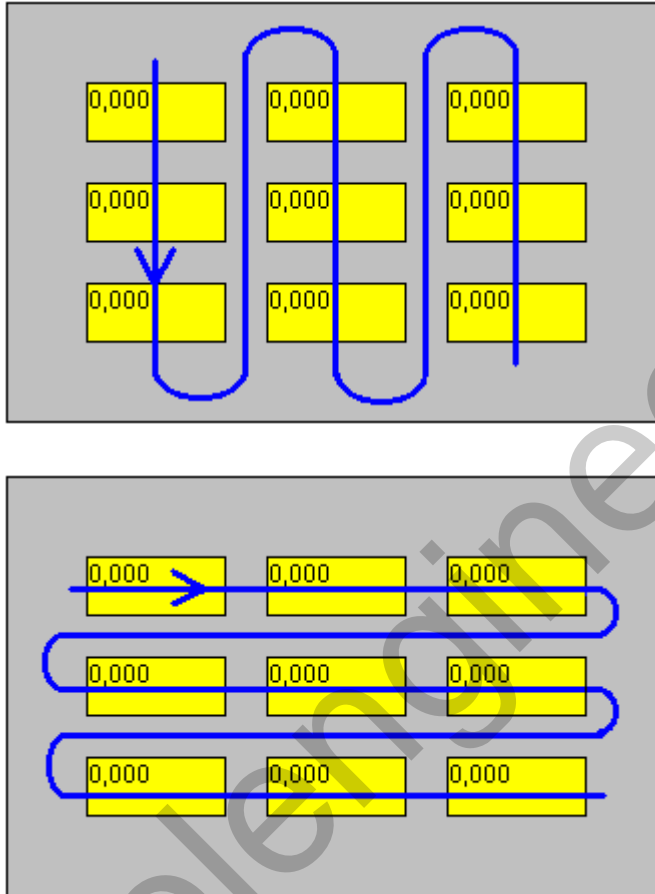

#### How to apply or cancel the settings you have made:

You apply all the settings you have made to your project by clicking the "OK" button. Alternatively, you can cancel such settings by clicking the "Cancel" button. If you click the "Help" button, you open the on-line help system.



From Basic Picture 6, you are then able to display Basic Picture 3 by means of the "Recall Picture" function. Picture 3 is now copied to the next position in the picture store. You can then use the "Forward" and "Backward" functions to open the pictures referenced in the picture store one after the other.

▲ Basic Screen 3
Basic Screen 6 → (G)
Basic Screen 5
Basic Screen 4
Basic Screen 3 (M)
Basic Screen 2
▼ Basic Screen 1

After you have switched basic picture to picture 5 using the "Backward" function and switched to the start picture using the "Start Picture" function, basic pictures 6 and 3 are deleted from the picture store and replaced by the start picture selected. The picture store looks as follows after these actions:

Basic Screen 1
Basic Screen 5 → (S)
Basic Screen 4
Basic Screen 3 (M)
Basic Screen 2
Basic Screen 1

When you select stored pictures or start pictures in the store, the picture in question is stored to the next position in the picture store.

---

**Note:**

Screen navigation in the Graphic Designer can also be configured by means of the library objects or the Dynamic Wizard. In the library indicated, open the book called "Global Library" and then the folder "Screen Navigation". This folder contains the objects NextPicture, PreviousPicture and StartPicture. After displaying the Dynamic Wizard in the Graphic Designer, select the Picture Functions tab and then the "Single Picture Change" function. Start the Dynamic Wizard by double-clicking.

---

Field	Meaning
Use prefix	Activate this check box if you do not want to display the files which begin with the prefix specified in the input box. If you want to hide system pictures, you have to enter the @ character.
Note upper/lower case	Activate this check box if you want to inputs to be case-sensitive when hiding the system files.

### 3.3 "Tag Management" Project Component

**This Is the Way the "Tag Management" Project Component is Structured:**

This component can have multiple sub-items. Communication drivers, which manage process tags, and "Internal Tags" are managed in the "Tag Management" project component.

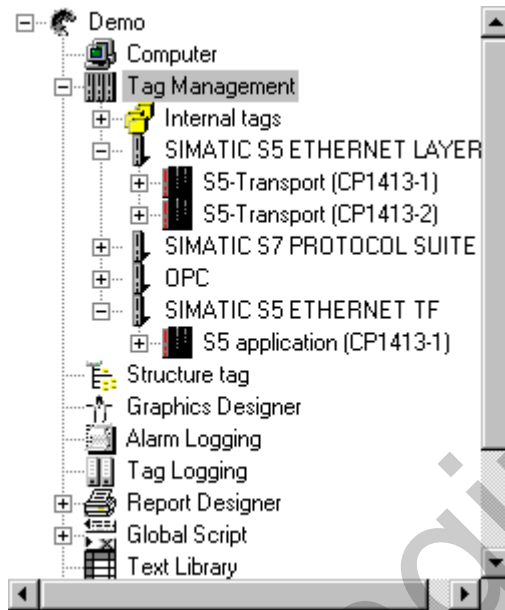

This example shows you six installed communication drivers and their channel units under the "Tag Management" project component.



Each communication driver can be made up of the following sub-items:

- 1 to n channel units
  - 1 to n logical connections. All tag groups and tags in the logical connection are managed and displayed in this area.
    - 1 to n tag groups. All tags of the tag group in the logical connection are displayed and managed in this area.
    - 1 to n independent tags. All tags that do not belong to a tag group are managed and displayed in this area.

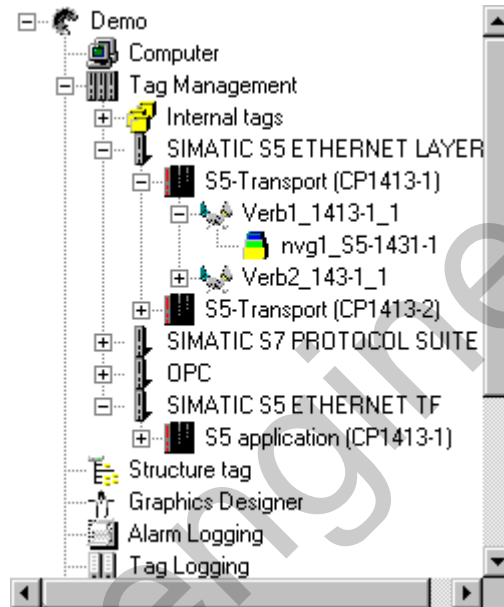

This example shows you the channel unit "S5-Transport (CP1413-1)" and its logical connections and tag groups under the communication driver "SIMATIC S5 ETHERNET LAYER 4".

### Properties of the "Tag Management" Project Component

How to Edit the Properties of the "Tag Management" Project Component:

1. In the Project Navigator Window, click the right mouse button on "Tag Management". In the pop-up menu that then appears, select the "Properties" menu item.
2. You can use the "Properties list of the communication driver" to start the following actions:
  - Use the "New..." button to add new communication drivers to your current project management.
  - Use the "Delete" button to delete the selected communication driver from your current project management. You can also delete multiple communication drivers at once.

### 3.4 WinCC Explorer Editors

Use the editors to edit and control a complete project. The following list contains all of the standard editors of the WinCC system. In the WinCC Explorer, the editors are located in the project navigation window.

#### Editors of the Basic WinCC System:

Editor	Meaning
Alarm Logging	Accepts messages from processes in order to prepare, display, acknowledge, and archive those messages.
User Administrator	Controls access authorizations for groups and users.
Text Library	Contains language-dependent text that you create.
Report Designer	Provides an integrated reporting system that you can use to report user data, current and archived process values, current and archived messages, and your own system documentation.
Global Script	Makes a project dynamic to your specific requirements This editor allows you to create C functions and actions that can be used throughout the project or across multiple projects depending on their type.
Tag Logging	Edits measurement values and stores them long term
CrossReference	Editor used to display locations where various object types, for example, tag, pictures and functions, have been used. Also includes the functions "usage location jump" and "rewire".
Graphics Designer	Displays and connects the process graphically

### Optional Editors of the WinCC System:

Editor	
<i>Storage</i>	The Storage function supports automatic swapping of data from the hard disk to long-term data carriers as well as deleting of data from the hard disk.
<i>Picture Tree Manager</i>	The <i>Picture Tree Manager</i> manages a hierarchy of plant names, plant section names, function names and pictures of the <i>Graphics Designer</i> .
<i>Time Synchronization</i>	Time Synchronization is a function for plants equipped with a SINEC L2/L2R bus system. A WinCC OS, being an active time-of-day master, synchronizes all remaining OSs and ASs connected to the plant bus with the current time of day. This enables chronologically correct assignment of messages throughout the entire plant.
<i>Lifebeat Monitoring</i>	The <i>Lifebeat Monitoring</i> editor has the following tasks: it permanently monitors the individual systems (OSs and ASs); it visualizes the results in the form of screen outputs in the runtime system; automatically triggers the audible indicator module (horn); and generates the process control system messages.
Base Data	Configuration of the WinCC base data using wizards.
<i>Split Screen Wizard</i>	The <i>Split Screen Wizard</i> is part of the Split Screen Manager. The wizard helps to configure and initialize the monitor and picture settings for the current WinCC project. You should execute this initialization as soon as you load a project because other applications (such as runtime and group display) access these data.
<i>Alarm Logging Wizard</i>	The <i>Alarm Logging Wizard</i> helps to configure and initialize the message windows, messages, message classes and range of the process control system messages as well as the horn tags for the current WinCC project.
<i>Tag Editor</i>	Use the Tag Editor to set tags and range assignments that are linked to a trend template by means of the "Create Trends On-Line" function.

#### Note

Additional information about the optional editors can be found in the manual entitled "WinCC Options"

## 3.5 Project Properties

A project consists of several or a large number of components which are directly dependent on each other. You can find the individual components of a project in the Project Navigation Window.

### Editing/Viewing the Project Properties:

If you want to view or edit the project properties, you must select the current project in the Project Navigation Window. Then you must open the corresponding pop-up menu and

select the "Properties..." menu item or use the  button in the toolbar.

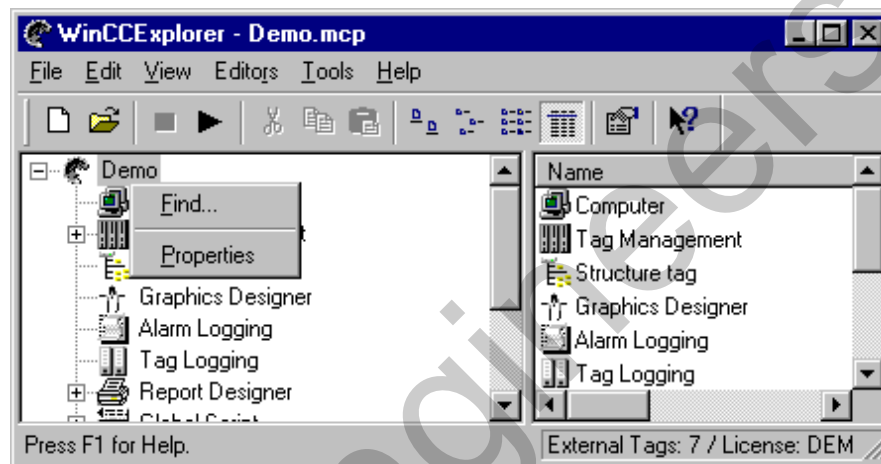

The pop-up menu of the current project is displayed in the data window.

### How to Edit the Project Properties:

1. In the Project Navigation Window, click the right mouse button on the project name. In the pop-up menu that then appears, click on the "Properties..." menu item.

or

Click the  button in the toolbar.

2. You can select one of the three tabs in the "Project Properties" dialog box.

### The individual tabs have the following meaning:

Tab	Meaning
General	General project data.
Update Cycle	Set the project-related time interval for updating the process image.
Hot Keys	Assign a hot key to certain actions in the WinCC system.

### "General" Tab

On the "General" tab, click on the box you want to edit. You can edit the boxes shown in the following table.

The individual boxes have the following meaning:

Area Name	Meaning
Type	The current project type is displayed in this box. You can manage a project as a "Single-User System" or a "Multi-User System." You can also use this box to change the project type.
Creator	The name of the project creator is entered in this box. This name corresponds to the user name that the creator of a project under Windows NT used to log on to the system.
Creation Date	The date on which the project has been created is entered in this box. This date corresponds to the system date on the computer on which the project was created.
Changed By	The name of the editor of the project is entered in this box.
Last Change	The date of the last change made to the project is entered in this box. This date corresponds to the system date on the computer on which the project was edited.
Version	The number of the current project version is entered in this box. Alphanumeric characters can be used here.
GUID	The project ID number is loaded in this box. A new number is created for each project. This identification is necessary for database handling.
Comment	Use this box to enter a comment you would like to make about the project in question. Alpha-numeric characters can be used here.

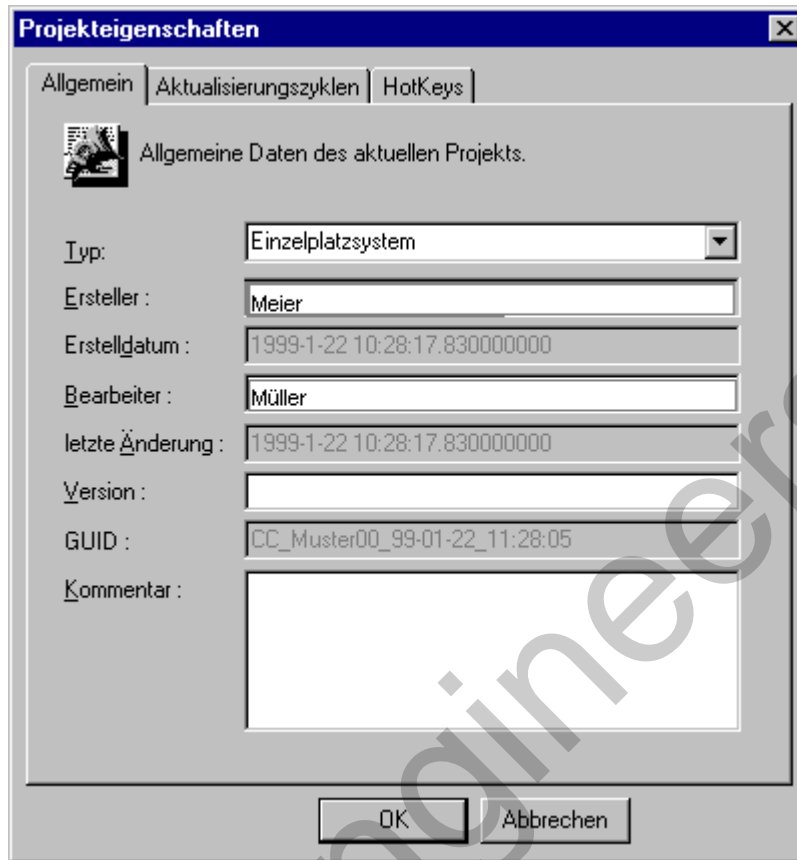

The screenshot shows a dialog box titled "Projekteigenschaften" with three tabs: "Allgemein", "Aktualisierungszyklen", and "HotKeys". The "Allgemein" tab is selected. Below the tabs, there is a small icon and the text "Allgemeine Daten des aktuellen Projekts." The form contains the following fields:

Typ:	Einzelplatzsystem
Ersteller:	Meier
Erstelldatum:	1999-1-22 10:28:17.830000000
Bearbeiter:	Müller
letzte Änderung:	1999-1-22 10:28:17.830000000
Version:	
GUID:	CC_Muster00_99-01-22_11:28:05
Kommentar:	

At the bottom of the dialog box, there are two buttons: "OK" and "Abbrechen".

This picture shows you the screen layout of the "General" tab.

## "Update Cycle" Tab

### Note:

The "update cycles" consist of preset and freely definable cycles. You can recognize the definable cycles by their standard identification "User Cycle n", where "n" corresponds to a range between 1 and 5. This means that you can assign a maximum of 5 definable user cycles.

### How to Select a Preset Update Cycle:

1. Click on the "Update Cycles" tab.
2. Select the update cycle required for your project.
3. Use the "OK" button to apply the selected update cycle.

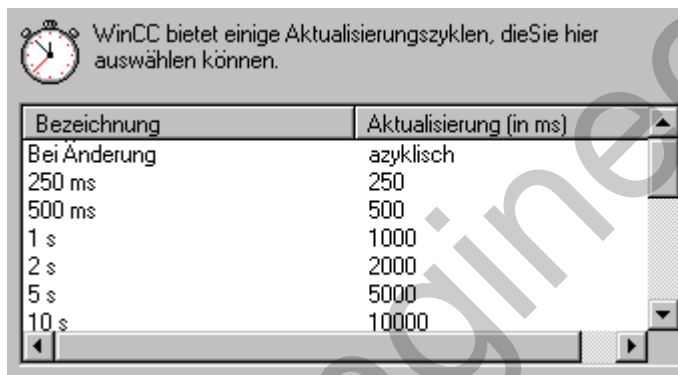

This example shows you some of the possible preset update cycles.

### How to Set an Update Cycle You Can Define Yourself:

1. Click on the "Update Cycles" tab.
2. Select one of the available (maximum 5) user cycles. (The user cycles you can define yourself are located at the end of the list).

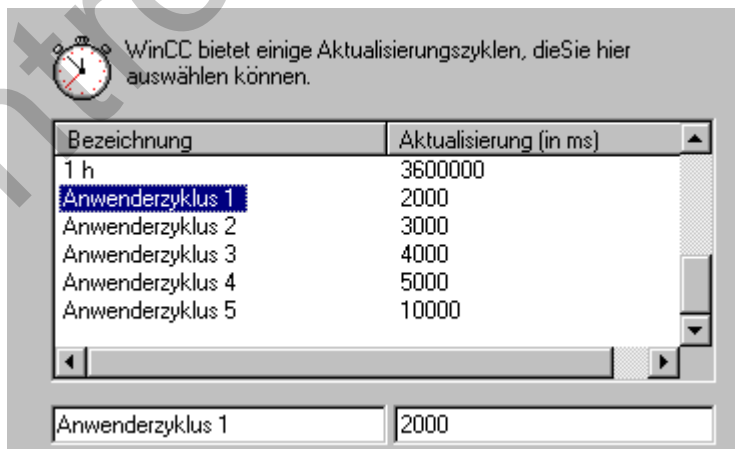

This example shows you the user cycles you can define yourself. The boxes that can be edited are located on the lower border.

3. If you want to change the name, click on the left box (for example, "User Cycle 1" as seen in the example) and change the name.
4. If you want to change the update cycle, click on the right box and change the value. You can enter a value from 100 ms to 3600000 ms (100 ms to 10 hr) in this box. The value entered is rounded up to the next value divisible by 100 (for example, if you enter 2111, the value is rounded up to 2200 when you press the *TAB* key).
5. Use the "OK" button to apply the selected update cycle.

---

**Note:**

If a user cycle is changed while the project is running in runtime, the change does not affect the runtime. The change does not take effect until you DEACTIVATE/ACTIVATE the project.

---

### "Hot Keys" Tab

How to Use the "Hot Keys" Tab to Assign a Hot Key to Specific Actions:

1. Click on the "Hot Keys" tab.
2. In the "Actions" box, select the action to be activated with a hot key.
3. The current hot key is displayed in the "Previously Assigned" box. If no hot key has been assigned, this box contains "None". In order to assign a hot key to the selected action, proceed as follows:
  - Click on the "Previously Assigned" box.
  - Now use the keys that you want to correspond to the hot key (for example <Shift> + <F6> or <Alt> + <F4>).
4. Click the "Assign" button. You can activate the selected action with the hot key you set.

---

**Note:**

With the hot keys for the "Log-on" and "Log-off" actions, you can log on to or off from a running runtime module. For example, if you assign the keystroke combination <Ctrl> + <Alt> + <N> to the "Logon" action, you must log on to a running runtime module using this keystroke combination. You can find more detailed information in the manual for the "User Administrator". If you want to execute the "Hardcopy" action by means of a hot key, you must connect the "PrtScr.exe" program in the Computer Startup List. The "PrtScr.exe" program is located in the "\bin" path of WinCC (for example "C:\WinCC\Bin or C:\Siemens\WinCC\Bin").

A hotkey code that has been assigned twice will not be detected by the system, reported or intercepted. You are responsible for managing the character strings used for hotkeys. A double assignment of a hotkey code will cause problems in runtime.

---



controlengineers.ir

## 4 Tag Management

### 4.1 General Information About Tags

WinCC tags are the central element for accessing process values. Within a WinCC project, they receive a unique name and a data type, among other things. A logical connection is assigned to a WinCC tag. This connection determines which channel delivers the process values to the tags using which connection. The WinCC tags are stored in a project-wide data base. When a WinCC machine starts, all of the tags belonging to a project are loaded and the corresponding run-time structures are set up.

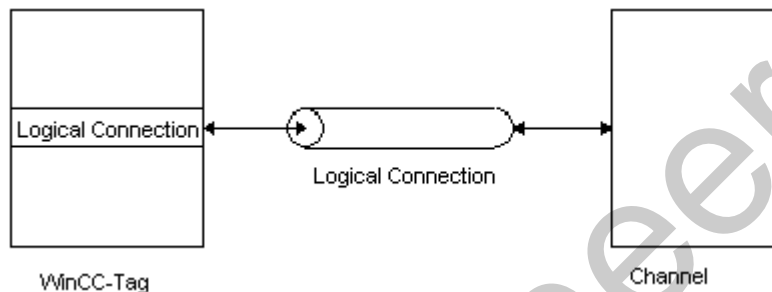

A WinCC tag describes a data cell that is unique within a project and the rules to be followed when this data cell is accessed.

For an application, access to the tag utilities of tag management is transparent. This means an application needs no information about the source or the target of the tags.

Generally, tag management differentiates between the following two types of tag.

Term	Explanation
Internal tags	No addressing in the AS level.
Process tags	Assignment to a logical connection and address in AS. Within the external tags, there is a special form of tag known as "Raw Data Tag".

#### Note:

Tags names and groups must be uniquely named throughout the entire project. The following naming conventions exist:

- No keywords (in acc. w. C convention)  
e.g.: float, type, main, void
- No special or connecting characters  
e.g.: ( @ + - / & ' " [ ] \* { } . : < > ; = \ )
- No empty spaces
- The length of tag names is restricted in WinCC to 128 characters
- There is no differentiation between upper case and lower case letters concerning the naming of tags.

### Within a Project, Tags Can Be Created and Managed at the Following Locations:

1. Within a connection, as independent tags
2. Within a connection, as tags in a tag group
3. Within the internal tags, as independent tags
4. Within the internal tags, tags as tags in a tag group
5. Within the project component "Tag Management", new tags in connections, tag groups, or as internal tags.

### Updating Tags with Process Values

The WinCC server tag management is responsible for providing the WinCC tags with process values at run time. The tag management provides the process values to its local WinCC tags as well as to the tags that belong to the corresponding WinCC client. The tag management transfers the tags to be updated to their logical connection and thus to the appropriate channel. The channel executes the necessary communication steps by means of its process bus in an optimized manner. This way, a minimum of data traffic is necessary on the process bus in order to assign values to all tags.

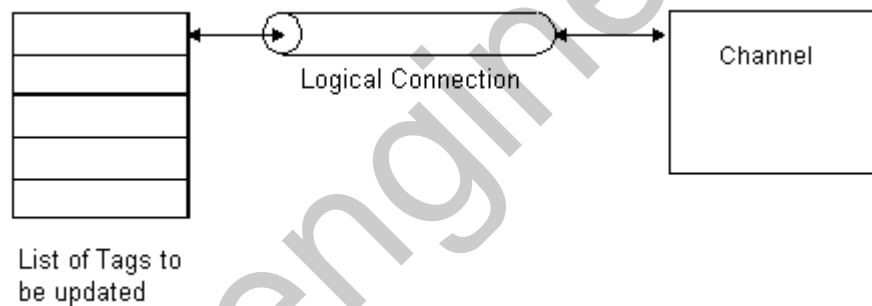

### Within a Project, Tags Can be Cut, Copied, or Deleted in the Following Manner:

The procedure for cutting, copying or deleting tags is the same for independent tags and tags within a group.

### Standard Data Types for Tags:

You must assign one of the standard data types to each tag. The tag is stored under this data type in the tag management.

### How To Cut, Copy or Delete One or More Tags:

---

#### Note:

The task sequence for cutting, copying, or deleting is the same for all tags.

---

1. To cut, copy, or delete tags, you must select the tags first. The tags can be found under the project component "Tag Management". Within this node, the tags can be found in groups, be assigned to internal tags or be managed as independent tags.
2. Select the tags and click the right mouse button.
3. In the pop-up menu that appears, select the menu item you want, i.e. "Cut", "Copy" or "Delete".

### How to Cut or Copy One or More Tags:

1. Select the target area to which you want to copy the selected tags.
2. Click the right mouse button in the data window.
3. In the pop-up menu that then appears, select the "Paste" menu item.
4. This action copies all of the selected tags to the target area. You must be aware of the following in this copy procedure:

Each of the copied tags receives a sequential number.

The "BinVarS5TF" tag is renamed to "BinVarS5TF\_1" after it is copied.

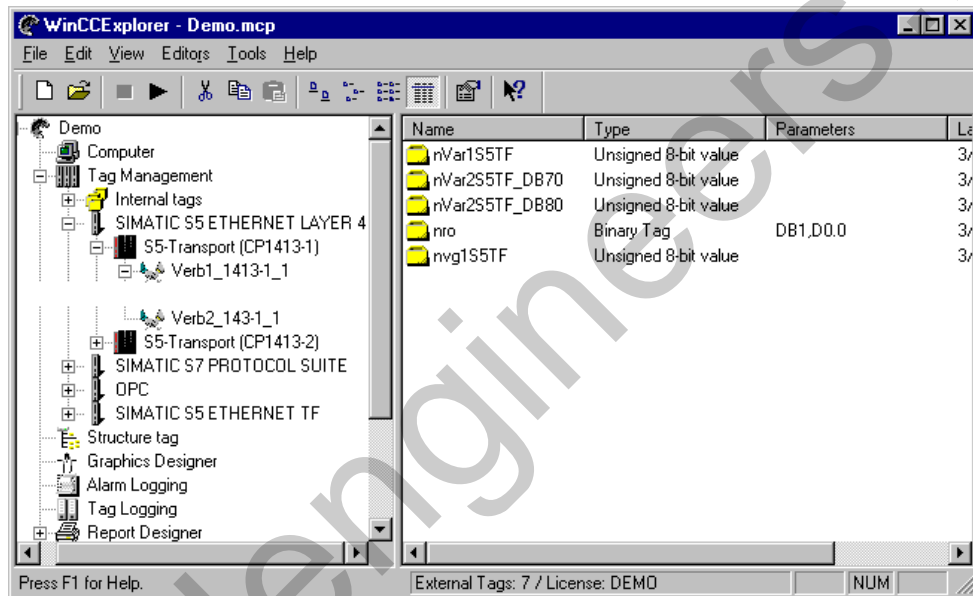

This example shows you the tags **before** the copy procedure.

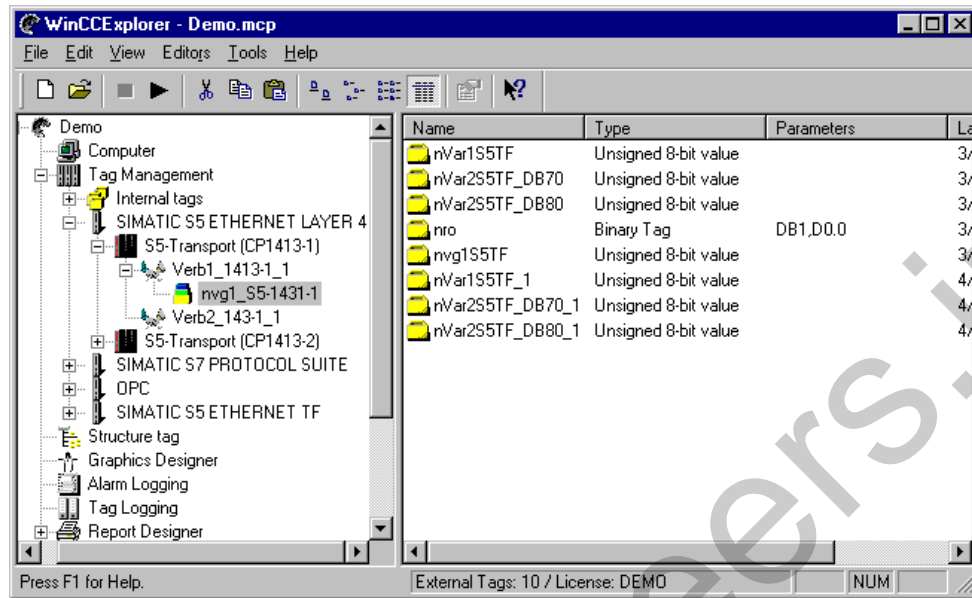

---

**Note:**

When copying and pasting a tag, any assignments configured to the tag (e.g. a message) are not copied over with it.

---

**If You Want to Delete One or More Tags:**

- The "Delete nnn Object(s)" window appears if you select the "Delete" pop-up menu item. Click the "Yes" button in this window. The selected tags are deleted (nnn is the number of selected objects).

## 4.2 Internal Tags

### How to Create a New Internal Tag for an Entire Project:

1. In the Project Navigation Window, double-click on the "Tag Management" project component. This action provides a list of all of the installed communication drivers and internal tags.
2. In the project navigation window, select the "Internal Tags" project component and click the right mouse button.
3. In the pop-up menu that appears, select the "New Tag..." menu item.
4. This selection opens the "Tag Properties" dialog, in which you can create a new tag.

### How to Edit Existing Internal Tags for an Entire Project:

1. In the Project Navigation Window, double-click on the "Tag Management" project component. This action provides a list of all of the installed communication drivers and internal tags.
2. Click on the "Internal Tags" project component to view a list in the project data window of all available tag groups and independent tags.
3. In the project data window, select the desired tag and click the right mouse button. In the pop-up menu that then appears, select the "Properties" menu item.  
or  
Double-click on the desired tag in the project data window.
4. This selection opens the "Tag Properties" dialog, in which you can edit an existing tag.

### 4.2.1 "Tag Properties" Dialog

---

#### Note:

If the selected tag was created by means of an external program and if a creator identifier (see ODK) was used in its creation, it is possible that you can view the tag within WinCC but not edit it (read only). If this is the case, you can recognize it by the following, the dialog title includes a "read only" entry and the "OK" button is displayed in gray and cannot be used. You can only use the "Cancel" button. You can neither delete nor rename tags with this kind of creator identifier. You can only copy these tags which makes the copied tag completely editable again.

---

The dialog box contains two tabs with the following contents:

Tab	Contents
General	General settings for the tag are set in the "General" tab. The structure of this tab differs for "Process Tags" and "Internal Tags".
Limits/Reporting	You can set the limits of the tag and set triggers for reporting certain events in the "Limits/Reporting" tab.

### "General" Tab for Internal Tags

Internal tags do not have an address in the supporting AS systems and are therefore provided by the tag management inside WinCC for the entire network. Internal tags are used to store general information like current date, time, current layer, and currently logged in user. In addition, internal tags enable a transparent data exchange between applications in order to implement inter-process communication in a centralized and optimized manner.

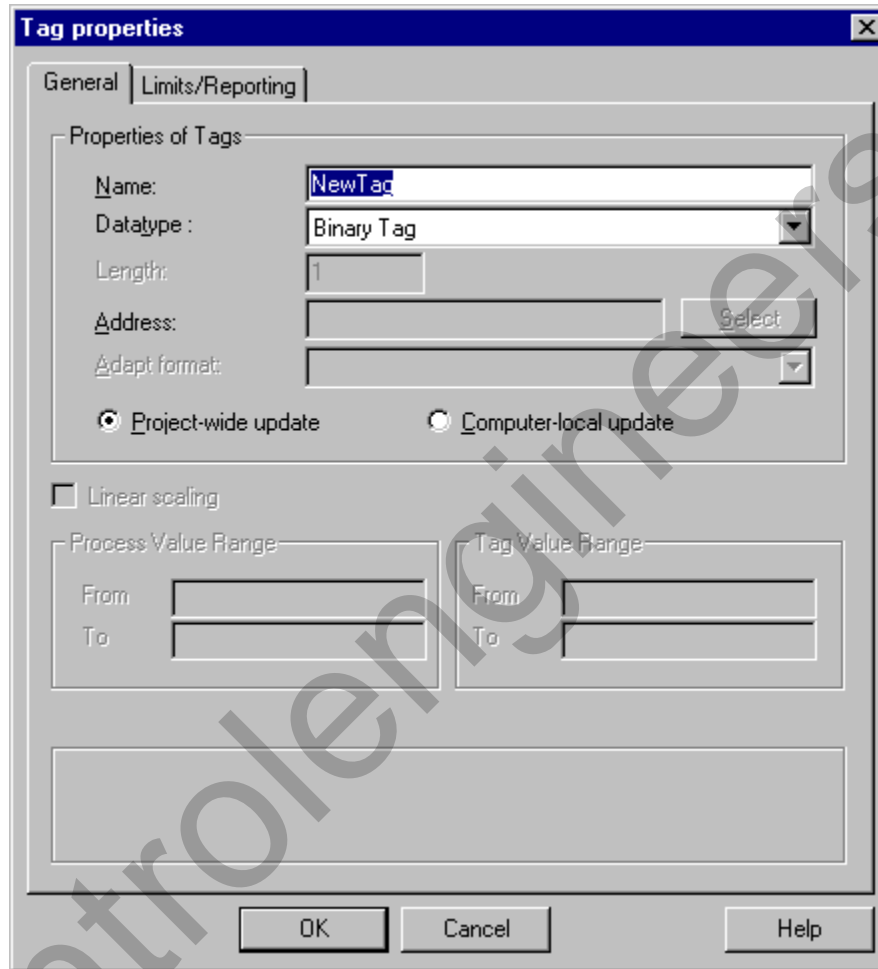

Box Name/Button	Meaning
Name	Enter a unique tag name in this box.
Project-wide update	The "Internal Tag" is updated for the entire project.
Computer-local update	The "Internal Tag" is updated for the local workstation.
Data type	Data type of the tags. The selected data type also affects whether you can edit the "Limits/Reporting" tab or the "Adapt Format" and "Address Parameters" boxes in the "General Information" tab.
Length	You can change the length of the selected data type in this box. This box can only be edited for the "Text Tag ..." data type.

**Note:**

Since several editors do not work internally with the tag names but with the tag identifiers, a renaming of a tag would cause, for example, a loss of an already configured message assignment. If renaming a tag cannot be avoided, the individual messages in "Alarm Logging" should be exported before specifying the new name and be imported afterwards to link them to the tag again.

**"Limits/Reporting" Tab**

Area Name	Meaning
High Limit	Set the maximum high limit for the tags. If the high limit value is exceeded, the value is NOT written. In this event, only a message flag is set.
Low Limit	Set the minimum low limit for the tags. If the low limit value is exceeded, the value is NOT written. In this event, only a message flag is set.
Start Value	Presettings with a start value, for example, for counters.
Replacement Value	If an event makes the implementation of a replacement value necessary, select this option.
<b>Use Substitute Value</b>	Determine when the substitute value is used.
At High Limit	When the value of the high limit is exceeded, the substitute value should be used.
At Low Limit	When the value of the low limit is undershot, the substitute value should be used.
As Start Value	The substitute value is used as the start value, for example, when a connection is interrupted.
During Connection Errors	When connection errors occur, the substitute value should be used.
<b>Generate Report Entry During</b>	Determine at which event a report entry is generated.
Violation of High Limit	Tag value of the high limit has been exceeded.
Violation of Low Limit	Tag value of the low limit has been undershot.
Conversion Error	An error occurs when converting the data type.
Write Access Applications	For each application, report the write access to a tag.
Write Access Process	For each process, report the write access to a tag.



**Tag properties** [X]

General Limits/Reporting

 Use this dialog box to specify the limits and reporting that the WinCC Data Manager should check.

High Limit:   Start Value

Low Limit:   Replacement:

Use Substitute Value

At High Limit  As Start Value

At Low Limit  During Connection Errors

Generate Report Entry During

Violation of High Limit  Write Access Applications

Violation of Low Limit  Write Access Process

Conversion Error

OK Cancel Help

## 4.2.2 Internal Tags in a Tag Group

### How to Create a New Internal Tag for an Entire Project within a Tag Group:

---

**Note:**

If there is no tag group in the internal tags, you must first create a tag group.

---

1. In the Project Navigation Window, double-click on the "Tag Management" project component. This action provides a list of all of the installed communication drivers and internal tags.
2. Click on the "Internal Tags" project component to view a list of all available tag groups.
3. Select a tag group and click the right mouse button.
4. In the pop-up menu that appears, select the "New Tag..." menu item.
5. This selection opens the "Tag Properties" dialog, in which you can create a new tag.

### How to Edit an Existing Internal Tag for the Entire Project within a Tag Group:

1. In the Project Navigation Window, double-click on the "Tag Management" project component. This action provides a list of all of the installed communication drivers and internal tags.
2. Click on the "Internal Tags" project component to view a list of all available tag groups.
3. Select a tag group and click the right mouse button.
4. In the project data window, select the desired tag and click the right mouse button. In the pop-up menu that then appears, select the "Properties" menu item.  
or  
Double-click on the desired tag in the project data window.
5. This selection opens the "Tag Properties" dialog, in which you can edit an existing tag.

## 4.3 Process Tags

### How to Create a New Independent Process Tag:

---

**Note:**

If the connection does not exist yet, you must first create the logical connection and create the new tag during this process.

---

1. In the Project Navigation Window, double-click on the "Tag Management" project component. This action provides a list of all of the installed communication drivers and internal tags.
2. In the Project Navigation Window, double-click on the desired communication driver. This action opens up a list of all available channel units.
3. Double-click on the desired channel unit to view a list of all available logical connections.
4. Select the desired logical connection and click the right mouse button.
5. In the pop-up menu that appears, select the "New Tag..." menu item.
6. This selection opens the "Tag Properties" dialog, in which you can create a new tag.

### How to Edit an Existing Independent Process Tag:

1. In the Project Navigation Window, double-click on the "Tag Management" project component. This action provides a list of all of the installed communication drivers and internal tags.
2. In the Project Navigation Window, double-click on the desired communication driver. This action opens up a list of all available channel units.
3. Double-click on the desired channel unit to view a list of all available logical connections.
4. Select the desired logical connection in the project navigation window.
5. All of the existing tags appear in the data window. Select the desired tag and click the right mouse button. In the pop-up menu that then appears, select the "Properties" menu item:  
or  
Double-click on the desired tag in the project data window.
6. This selection opens the "Tag Properties" dialog, which you can edit existing tags.

### 4.3.1 "Tag Properties" Dialog

---

**Note:**

If the selected tag was created by means of an external program and if a creator identifier (see ODK) was used in its creation, it is possible that you can view the tag within WinCC but not edit it (read only). If this is the case, you can recognize it by the following:

The dialog title includes a "read only" entry and the "OK" button is displayed in gray and cannot be used. You can only use the "Cancel" button. You can neither delete nor rename tags with this kind of creator identifier. You can only copy these tags which makes the copied tag completely editable again.

---

The dialog box contains two tabs with the following contents:

Tab	Contents
General	General settings for the tag are set in the "General" tab. The structure of this tab differs for "Process Tags" and "Internal Tags".
Limits/Reporting	You can set the limits of the tag and set triggers for reporting certain events in the "Limits/Reporting" tab.

### "General" Tab for Process Tags

In the WinCC system, external tags are also known as process tags. External tags are linked to a logical connection. In order to mirror the address information of the various AS systems, external tags consist of a general section which contains information like name, type, and limit values, and a connection-specific section whose interpretation depends on the logical connection. The tag management always provides the specific section of external tags to the applications in a text format.

Box Name/Button	Meaning
Name	Enter a unique tag name in this box.
Data type	Data type of the tags. The selected data type also influences whether you can edit the fields "Adapt Format" and "Address", as well as the settings in the "Limits/Reporting" tab.
Length	You can change the length of the selected data type in this box. This box can only be edited for the "Text Tag..." data type.

Box Name/Button	Meaning
Address	The structure of this window depends on the data type and the selected channel DLL. This field can be edited via the "Select" button.
"Select" button	This button opens the "Address Properties" dialog. In this dialog, you can set the precise address of the tag in the subordinate PLC.
Adapt format	You can convert the selected data type to another data type (for example, data type "Signed 8-bit value" adapt format to "CharToUnsignedByte"). The first format marks the data type in WinCC, the second format the data type in the automation system.
Linear scaling	If this option is selected, the value range of a process tag can be mapped to an internal value range, which allows you to scale the process tag.
Process Value Range	Set the process value range of the tags to be scaled by entering the minimum and maximum values.
Tag Value Range	Set the value range in which the process tag will be mapped by entering the minimum and maximum values.

---

**Note:**

Since several editors do not work internally with the tag names but with the tag identifiers, a renaming of a tag would cause, for example, a loss of an already configured message assignment. If renaming a tag cannot be avoided, the individual messages in "Alarm Logging" should be exported before specifying the new name and be imported afterwards to link them to the tag again.

If you change the data type of an already existing external tag, its defined tag address will be deleted. This action is justified by the fact that a data type change also changes the PLC address.

---

### "Limits/Reporting" Tab

The individual boxes have the following meaning:

Area Name	Meaning
High Limit	Set the maximum high limit for the tags. If the high limit value is exceeded, the value is NOT written. In this event, only a message flag is set.
Low Limit	Set the minimum low limit for the tags. If the low limit value is exceeded, the value is NOT written. In this event, only a message flag is set.
Start Value	Presettings with a start value, for example, for counters.
Replacement Value	If an event makes the implementation of a replacement value necessary, select this option.
Use Substitute Value	Determine when the substitute value is used.
At High Limit	When the value of the high limit is exceeded, the substitute value should be used.
At Low Limit	When the value of the low limit is undershot, the substitute value should be used.
As Start Value	The substitute value is used as the start value, for example, when a connection is interrupted.
During Connection Errors	When connection errors occur, the substitute value should be used.
Generate Report Entry During	Determine at which event a report entry is generated.
Violation of High Limit	Tag value of the high limit has been exceeded.
Violation of Low Limit	Tag value of the low limit has been undershot.
Conversion Error	An error occurs when converting the data type.
Write Access Applications	For each application, report the write access to a tag.
Write Access Process	For each process, report the write access to a tag.

**Tag properties** [X]

General Limits/Reporting

 Use this dialog box to specify the limits and reporting that the WinCC Data Manager should check.

High Limit: 
 Start Value:

Low Limit: 
 Replacement:

Use Substitute Value

At High Limit
  As Start Value

At Low Limit
  During Connection Errors

Generate Report Entry During

Violation of High Limit
  Write Access Applications

Violation of Low Limit
  Write Access Process

Conversion Error

OK Cancel Help



### 4.3.2 Process Tags in a Tag Group

#### How to Create a New Process Tag within a Tag Group:

---

**Note:**

If there is no tag group within a connection, you must first create a tag group.

---

1. In the Project Navigation Window, double-click on the "Tag Management" project component. This action provides a list of all of the installed communication drivers and internal tags.
2. In the Project Navigation Window, double-click on the desired communication driver. This action opens up a list of all available channel units.
3. Double-click on the desired channel unit to view a list of all available logical connections.
4. Double-click on the desired logical connection to view a list of all available tag groups.
5. Select the desired tag group and click the right mouse button.
6. In the pop-up menu that appears, select the "New Tag..." menu item.
7. This selection opens the "Tag Properties" dialog, in which you can create a new tag.

#### How to Edit an Existing Process Tag within a Tag Group:

1. In the Project Navigation Window, double-click on the "Tag Management" project component. This action provides a list of all of the installed communication drivers and internal tags.
2. In the Project Navigation Window, double-click on the desired communication driver. This action opens up a list of all available channel units.
3. Double-click on the desired channel unit to view a list of all available logical connections.
4. Double-click on the desired logical connection to view a list of all available tag groups.
5. Select the desired tag group.
6. In the project data window, select the desired tag and click the right mouse button. In the pop-up menu that then appears, select the "Properties" menu item.  
or  
Double-click on the desired tag in the project data window.
7. This selection opens the "Tag Properties" dialog, in which you can create a new tag.

### 4.3.3 Addressing a Process Tag

---

**Note:**

Process tags are also called external tags in the following discussion.

---

Each external tag has a channel-specific address description of the source of the process value. The type of address description depends on the type of the remote PLC of the channel unit.

External tags are linked to a logical connection. In order to mirror the address information of the different AS systems, external tags consist of a general section which contains information like name, type, and limit values, and a connection-specific section, whose interpretation is the responsibility of the logical connection.

**How Can One Address a Process Tag?**

There are two ways to provide the necessary address information to a process tag:

1. Use the pop-up menu of a selected tag.
2. Use the properties of a selected tag.

**Addressing by Means of the Pop-Up Menu**

How to Address a Process Tag:

1. In the Project Navigation Window, double-click on the "Tag Management" project component. This action provides a list of all of the installed communication drivers and internal tags.
2. In the Project Navigation Window, double-click on the desired communication driver. This action opens up a list of all available channel units.
3. Double-click on the desired channel unit to view a list of all available logical connections.
4. If the tag you want to edit is an independent tag or is located in a tag group, you must proceed as follows:
  - 4.1 If the tag you want to edit is an independent tag:
    - Click on the desired logical connection.
  - 4.2. If the tag you want to edit is in a tag group:
    - Double-click on the desired logical connection in the project navigation window to view a list of all available tag groups and independent tags.
    - Click on the desired tag group.
5. In the data window, select the desired tag and click the right mouse button.
6. In the pop-up menu that then appears, select the "Addressing..." menu item.
7. This selection opens the "Address Properties" dialog. in which you can address the process tag.

## Addressing by Means of the Properties of a Tag

How to Address a Process Tag:

1. In the Project Navigation Window, double-click on the "Tag Management" project component. This action provides a list of all of the installed communication drivers and internal tags.
2. In the Project Navigation Window, double-click on the desired communication driver. This action opens up a list of all available channel units.
3. Double-click on the desired channel unit to view a list of all available logical connections.
4. If the tag you want to edit is an independent tag or is located in a tag group, you must proceed as follows:
  - If the tag you want to edit is an independent tag: Click the desired logical connection.
  - If the tag you want to edit is located in a tag group, you must proceed as follows: In the Project Navigation Window, double-click on the desired logical connection. This action opens up a list of all available tag groups and all independent tags. Click on the desired tag group.
5. In the data window, select the desired tag and click the right mouse button.
6. In the pop-up menu that then appears, select the "Properties" menu item.
7. This selection opens the "Tag Properties" dialog.
8. In the "Tag Properties" dialog, click the "Select" button.
9. This selection opens the "Address Properties" dialog, in which you can address the process tag.

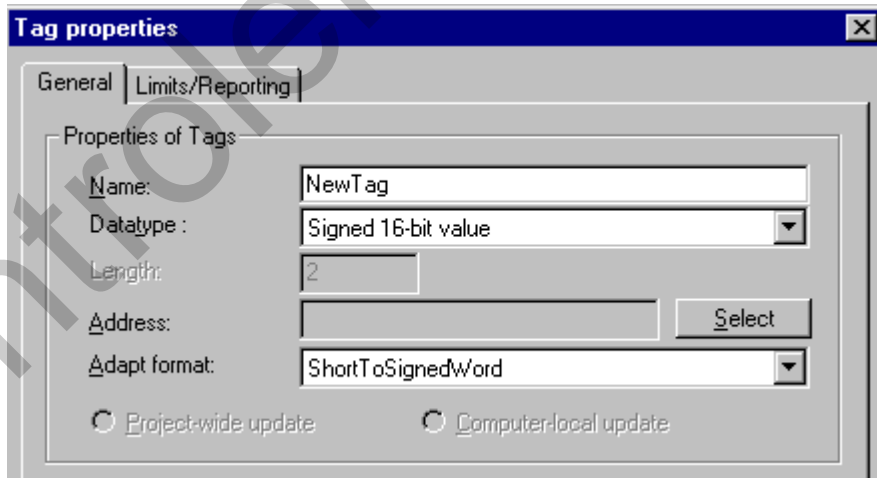

**Tag properties**

General | Limits/Reporting

Properties of Tags

Name: NewTag

Datatype : Signed 16-bit value

Length: 2

Address:

Adapt format: ShortToSignedWord

Project-wide update  Computer-local update

## 4.4 Standard Data Types

The following data types are available in WinCC:

Data Types	Adapt format
Binary Tag	No
Signed 8-bit value	Yes
Unsigned 8-bit value	Yes
Signed 16-bit value	Yes
Unsigned 16-bit value	Yes
Signed 32-bit value	Yes
Unsigned 32-bit value	Yes
Floating-point number 32-bit IEEE 754	Yes
Floating-point number 64-bit IEEE 754	Yes
Text tag 8-bit character set	No
Text tag 16-bit character set	No
Raw Data Type	No
Text reference	No
Structure tag (= Structure types)	No

You must assign a data type to each configured tag. The assignment of the data type to a tag is executed while creating new tags. The data type of a tag is independent of the tag type (for example, process or internal tag). In WinCC, you can convert certain data types to other data types by adapting the formats.

---

### Note:

If you change the data type of an already existing external tag, its defined tag address will be deleted. This action is justified by the fact that a data type change also changes the PLC address.

---

### Note

For a complete description of the data types, please consult the Online Help.

---

## "Text reference" Data Type

You can create only INTERNAL tags in this data type. The tag created in this manner refers to an entry within the "Text Library" ("Text ID" box).

### Assigning a Text ID Number:

Activate the "Start Value" check box in the "Tag Properties" dialog and enter the text ID number. The number you enter here must agree with the "Text ID" within the "Text Library."

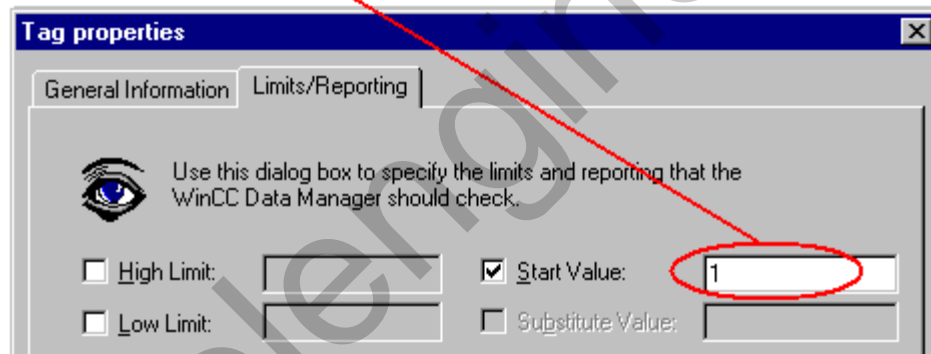
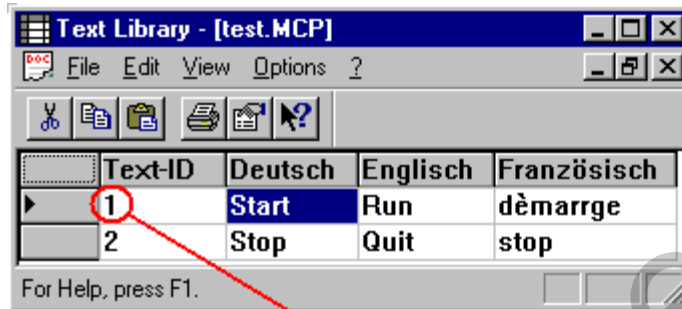

### Creating a New Text Reference Tag:

Use the following steps to create a new text reference tag:

1. In the project navigation window, right-click on the "Internal Tags" project component.
2. Select the "New Tag" entry from the displayed pop-up menu.
3. The "Tag Properties" dialog window will be opened. Select the "Text Reference" data type in the "Properties of Tags" field.

### "Structure tag (= types)" Data Type

Use this data type to create a data structure that is oriented to your needs. You can combine different default data types with each other so that the new data structure forms a logical unit.

#### Note:

You cannot adapt the format of this data type. You can only adapt the format of individual data types within the data structure. You can only edit an existing data structure if you have not configured any tags with the data type. If you want to change an existing data structure, you must first delete the configured tags. The "Structure Properties" dialog box notifies you of the presence of a configured instance (tag) by means of the following text in the window title bar: "(Instances Still Present! Read Only)."

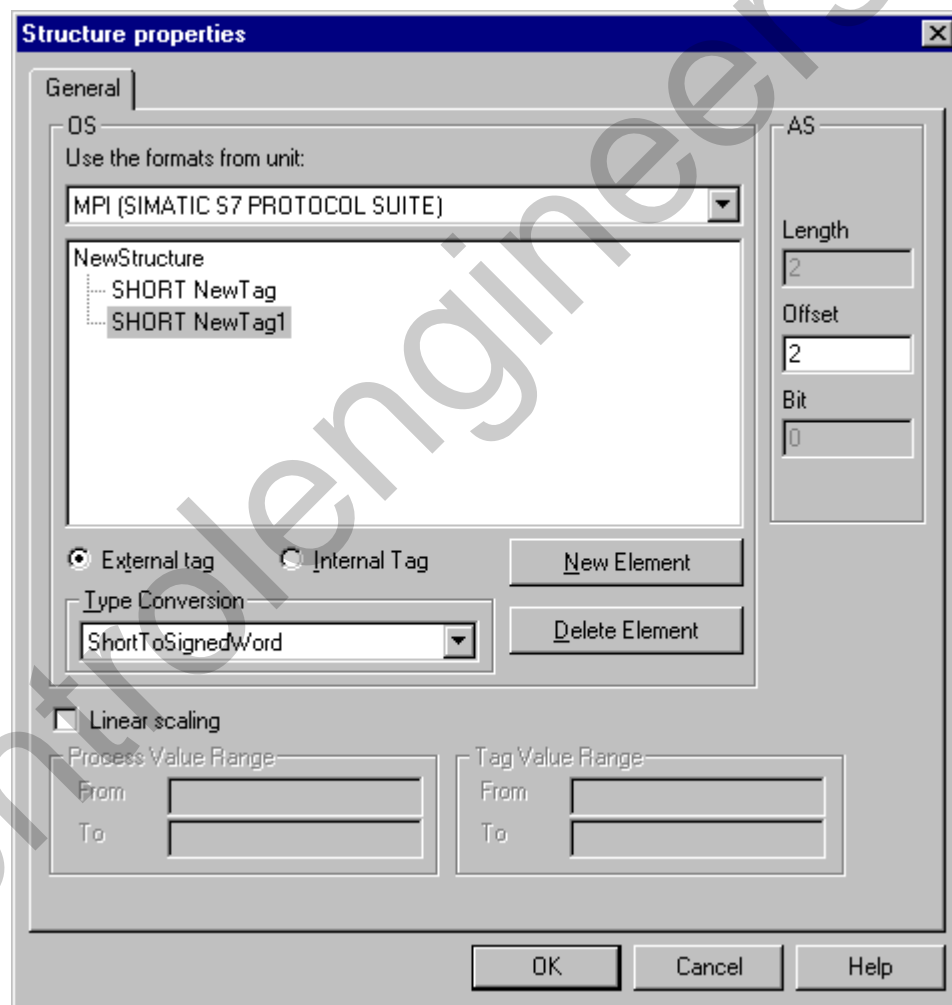

### Creating a New Structure Type:

Use the following steps to create a new structure type:

- In the Project Navigation Window, double-click on the "Data Types" project component to view a list of all data types.
- Click the right mouse button on the "Structure tag" (= Structure types) data type.
- In the pop-up menu that appears, select the "New Structure Type..." menu item.
- The "Structure properties" dialog opens and you can create the structure of the data structure.

### Structure and Editing Possibilities Within the "Structure properties" Dialog :

OS (Operator Station):

The data structure is created in this area.

You can connect a new data structure to the supported formats of a unit via the listbox "Use the formats from unit". If you select a unit, the "Type Conversion" list box will only display formats supported by the selected unit.

Each entry within the data structure can be adapted to either an external or an internal tag. If you activate the "External Tag" check box, you can undertake a special format adaptation if necessary. To adapt the format of an existing data type, use the  button and select the new data type from the list box. You cannot adapt the format of an "Internal Tag". The beginning of this area contains the name of the data structure. The default name is "NewStructure". You can also change this name by selecting the "NewStructure" box and opening the pop-up menu. Select the "Rename" menu item from the pop-up menu and edit the name of the structure. If you want to add a new data type to the data structure, use the "New Element" button. You can add a new data type to the existing data structure in the two following ways:

1. Select the name of the data structure and use the "New Element" button to connect the "SHORT NewTag" data type as a default.
2. Within the existing data structure, select the data type of which you want to create an additional entry and use the "New Element" button to connect the data type of the selected entry. When you connect a new data type in this manner, you must note the following: not only the data type of the entry selected is adopted but also the "external/internal tag" setting.

To delete an entry in this data structure, select the entry and use the "Delete Element" button. You can change the data type by performing the following steps: select the structure element you want to change. Open the pop-up menu and select the new data type. The pop-up menu offers you the following data types by default:

**BIT**  
**CHAR**  
**BYTE**  
**SHORT**  
**WORD**  
**LONG**  
**DWORD**  
**FLOAT**  
**DOUBLE**  
**TEXT8**  
**TEXT16**  
**TEXTREF** (with internal tags only)

AS:

If you activated "External Tag" within the OS area for a structure element, you can use the "Offset" input box to enter the required offset value for the database. The "Length" of the selected data type is also displayed in this area of the window. You can only edit this value if you selected the "TEXT8..." or "TEXT16..." data type.

Linear scaling

Linear scaling maps the value range of the process tag to an internal value range. Set the value ranges in the "Process Value Range From/To" and "Value Range of Tag From/To" entry fields. The linear scaling check-box is only enabled for external tags.

#### Using the BIT Data Type:

BIT tags always have a structure of 16-bit words. Therefore, bit positions 0 to 15 are the only positions possible. To use every single BIT of a 16-bit word, proceed as follows:

1. Select the last entry in the structure list and use the "New Element" button.
2. Select the new structure element and click the right mouse button to open the pop-up menu. Select the BIT data type.
3. Select the structure element again and click the right mouse button to open the pop-up menu. Select the "Rename" menu item.
4. Enter a logical name (for example, "Tag\_Bit\_00") for the structure element. The numeric entry "00" is very sensible for automatic numbering. Note the offset value because you must enter that value later in the structure elements "Tag\_Bit\_01" to "Tag\_Bit\_15."
5. Now click the "New Element" button 15 times to load the "Tag\_Bit\_01" to "Tag\_Bit\_15" structure elements. The correct offset value (from "Tag\_Bit\_00") as well as the required bit numbers are entered automatically.

#### Addressing the Database of a Configured Structure Tag:

If you create a new tag of the "Structure" type within a connection, you can use this tag to set the address of the database.

1. In the Project Navigation Window of the WinCC Explorer, double-click on "Tag Management".
2. Double-click on the required communication driver.
3. Double-click on the required channel unit.
4. Select the necessary connection in the Project Navigation Window. to view a list of all of the configured tags in the data window.
5. In the Data Window, select the structure tag with the "Structure" type.
6. Open the pop-up menu and select the "Addressing" menu item.
7. This selection opens the "Address properties" dialog. in which you can set the address of the database.



### Deleting a Configured Structure Tag:

If you want to delete a configured structure tag, proceed as follows:

1. In the Project Navigation Window of the WinCC Explorer, double-click on "Data Types".
2. Double-click on "Structure tag" (= Structure types).
3. Select the required configured structure which contains the tag you want to delete.
4. In the Data Window, select the structure tag.
5. Open the pop-up menu and select the "Delete" menu item.
6. The "Delete an Object" dialog opens. Click the "Yes" button in this window to delete the configured tag in the configured connection.

### Changing the Name of a Configured Structure Tag:

If you want to change the name of a configured structure tag, proceed as follows:

1. In the Project Navigation Window of the WinCC Explorer, double-click on "Data Types".
2. Double-click on "Structure tag" (= Structure types).
3. Select the required configured structure that contains the tag whose name you want to change.
4. In the Data Window, select the structure tag.
5. Open the pop-up menu and select the "Properties" menu item.
6. This selection opens the "Tag properties" dialog. In which you can enter the new name in the "Name" box. The new name of the tag is also updated in the configured connection.

---

#### Note:

If you want to change the name within a configured connection, the "Rename Object" message window opens. This window notifies you that you cannot change the name of the tag at this location.

---

## 4.5 Raw Data Tags

In addition to process tags, the tag management manages so-called raw data tags. From a general point of view, a raw data tag corresponds to a data message frame on the transport level. A raw data tag is not interpreted by the tag management. In order to achieve a certain preselection depending on the additional processing of raw data tags, a raw data tag has a specific type.

---

### Note:

A tag of this type cannot be displayed in the "Graphics Designer". Raw data tags are only used in the following applications in the WinCC system: "Alarm Logging," "Tag Logging," and "Global Scripts".

The writing of raw data to word-oriented PLCs is only possible if an even number of bytes is written to a word limit.

---

### For example, the communication driver "SIMATIC S7 Protocol Suite":

- The "SIMATIC S7 Protocol Suite" channel DLL differentiates among the following raw data types:
  - RDT\_EVENT                      Event processing
  - RDT\_ARCHIV                    Archive data connection
  - RDT\_BSEND                    Sending/receiving a data block
  - RDT\_S7PDU                    Transparent communication

A message system usually sends a message for an "RDT\_EVENT" raw data type. Process data acquisition accesses tags of the 'RDT\_ARCHIV' and 'RDT\_BSEND' types. The 'RDT\_S7PDU' raw data type is planned for independent use. This way, S7 PDUs that cannot be edited with the channel DLL or the S7 PMC DLL (for example, Object Management System (OMS) and Test and Startup (TIS) functions), can be edited with an (external) WinCC application.

The channel DLL selects received S7 Protocol Data Units (PDUs) by means of the PDU header and transmits the corresponding PDUs to the corresponding raw data tags. The WinCC application transmits the raw data tag to a conversion DLL independent of the channel type and raw data type. In an S7 channel, the "RDT\_EVENT" and 'RDT\_ARCHIV' raw data types are transmitted to the S7 Process Monitoring Control (PMC) DLL.

Term	Explanation
PDU	Protocol Data Unit
PMC	Process Monitoring Control
OVS	Object Management System
TIS	Test and Startup

## 4.6 "Address Properties" Dialog

Use this dialog to set the address of the process tags within the connected remote PLC.

### Structure of the "Address Properties" Dialog:

The dialog contains one or more tabs whose content depends on the current communication driver. Further information about this dialog can be found in the manual entitled "Channels".

## 4.7 "Select Tag" Dialog

The "Select Tag" Dialog is used to display tags or icons from various data sources by means of a selection window and, for example, to interconnect them with picture objects in the Graphics Designer. The data sources displayed are specified in the "Data Source" area.

Data transfer, for example, of selected Step 7 icons (Simatic S7), is used to add these icons to the stock of WinCC tags.

The filter function enables you to reduce the selection of tags and icons in order to make your search efficient.





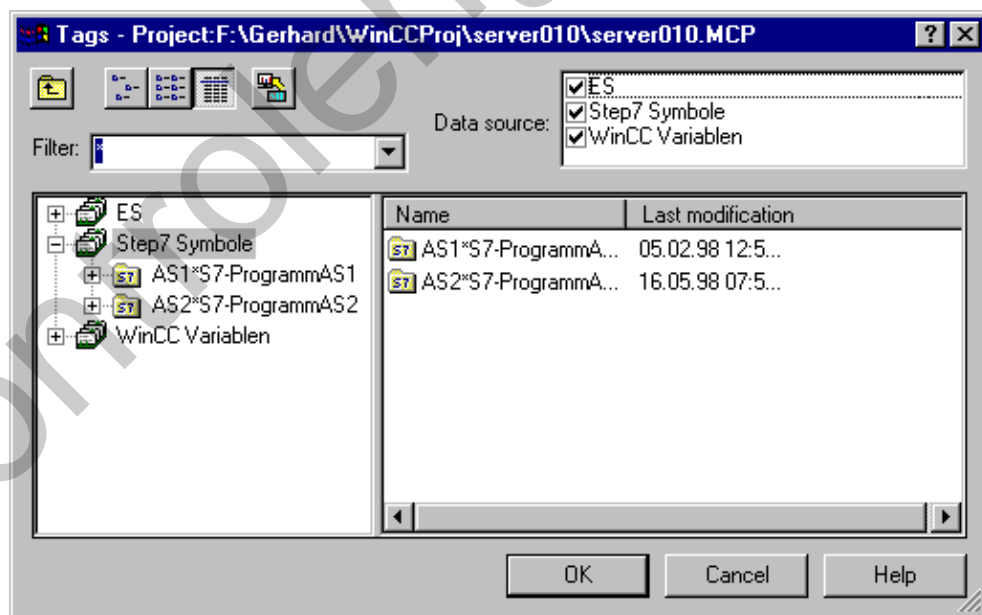

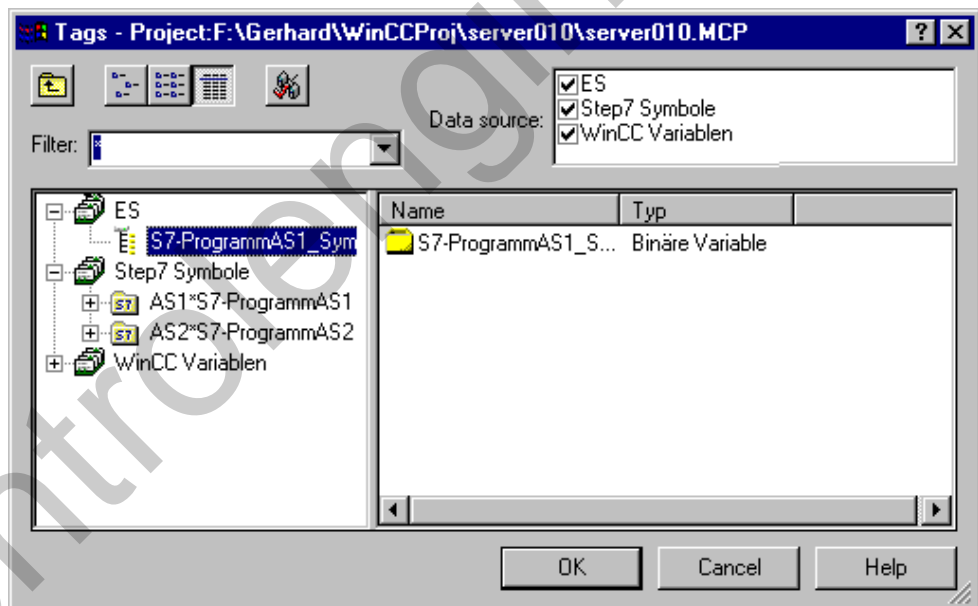
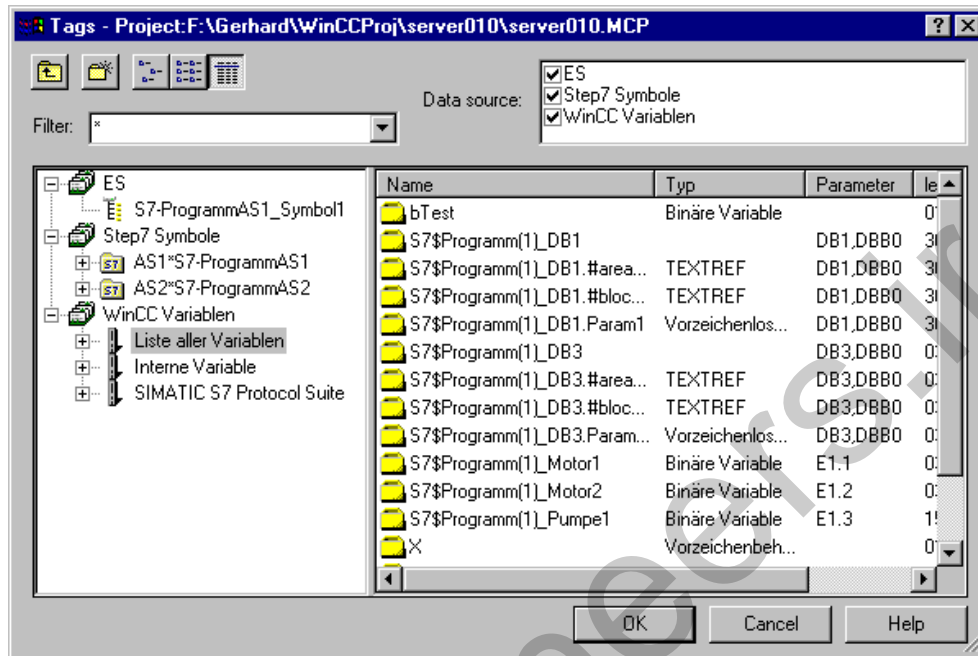
### Note:

The appearance of the dialog and the selectability of the various data sources depends on the installation of PCS7.





### Structure of the "Select Tag" Dialog:

Field	Meaning
Project	Displays the path and name of the current project.
Tag Filter	<p>In this field, using the placeholders "*" and "?", a search condition can be defined for a tag name. Only textual filters can be used for a name search. After the field is exited via the "TAB" key, only the tags that meet the search condition will remain displayed. The last 20 entered search conditions will be saved.</p> <p>Example: The following internal tags have been created in WinCC: "var1"; "var2"; "var3"; "smv2" and "apm1". Select the "List of all Tags" folder to search in all folders. As the search condition, "s*" is entered and the field exited by clicking on the "TAB" key. All tags starting with "s" will be displayed in the data field of the selected folders. In this case, the tag "smv2" will be displayed in the "List of all Tags" folder.</p>
Data Source	Activate the "WinCC Tags" check box to display a list of all WinCC tags (internal tags and process tags).
	Activate the "Step 7 Icons" check box to display a list of all Step 7 icons.
	Activate the "ES" check box to display a list of all PCS7 process tags.
	This button opens the next-highest folder (directory).
	This button allows you to create a new tag.
	This button sets the display type "Small Icons" for the window.
	This button sets the display type "Detailed View" for the window.
	This button enables you to transfer data. After selecting the tags/icons from the selected data sources, they are added to the data stock of WinCC by means of the "Transfer Data" function.
	This button enables you to update CFC/SFC connections (Continuous Function Chart, Sequential Function Chart). On clicking this button, Step7 connections (inputs and outputs) that have been extended are updated on the WinCC side and in this way made available.

### Data Source "ES"

The PCS7 process tags are displayed. The "Update CFC/SFC Connections" button enables you to update CFC/SFC connections. This is necessary if names have been changed, for example, by renaming in the Technological Hierarchy in the CFC or SFC.

### Data Source "Step7 Icons"

The Step7 icons are displayed. The tag dialog also displays instance data blocks which, however, cannot be mapped. Instance data blocks are created in the Simatic Manager. Hiding these icons will lead to performance problems. No parameters are displayed, which also means that accidental mapping is not possible. Clicking the "Transfer Data" button adds selected Step7 icons to the stock of WinCC tags.

### Data Source "WinCC"

All configured internal and external tags are displayed. You can create new tags using the "Create a new tag" function. The filter function allows you to search for tags that conform to your search criterion.

## 4.8 Tag Group

### 4.8.1 General Information About a Tag Group

A logical connection describes the interface between the automation system and the data manager. Each tag group is assigned to a channel unit. A channel unit can contain multiple tag groups.

---

**Note:**

The name of the tag group must be unique throughout the entire project. If this requirement is not fulfilled, a window appears with the name of the tag group that was already assigned in the project.

---

**There are three ways to create a tag group:**

---

**Note:**

The third item also deals with deleting tag groups.

---

1. Create a new connection and assign a tag group to it.
2. Assign a tag group to an existing connection.
3. Cut, copy, or delete one or more existing tag groups.

### 4.8.2 Creating a Tag Group in a New Connection

**How to Create a Tag Group When You Create a New Connection:**

1. In the Navigation Window, double-click on the project component "Tag Management". A list of all of the installed communication drivers is then displayed.
2. In the Navigation Window, double-click on the desired communication driver. This action opens up a list of all available channel units.
3. Select the desired channel unit and click the right mouse button.
4. In the pop-up menu that appears, select the "New Driver Connection..." menu item.
5. This selection opens the "Connection properties" dialog box in which you can create new logical connections.

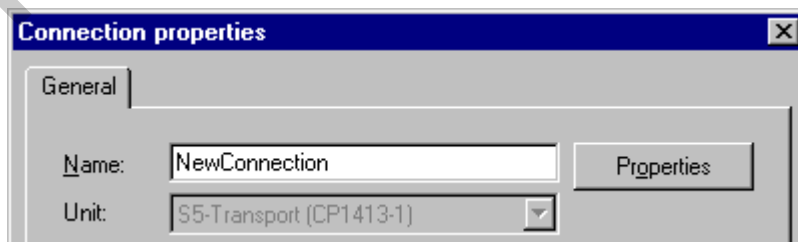

6. In the "General" tab, enter the name of the logical connection in the "Name" box.
7. Click the "OK" button.

8. Select the new connection, click the right mouse button on it and select the "Properties" option from the pop-up menu.

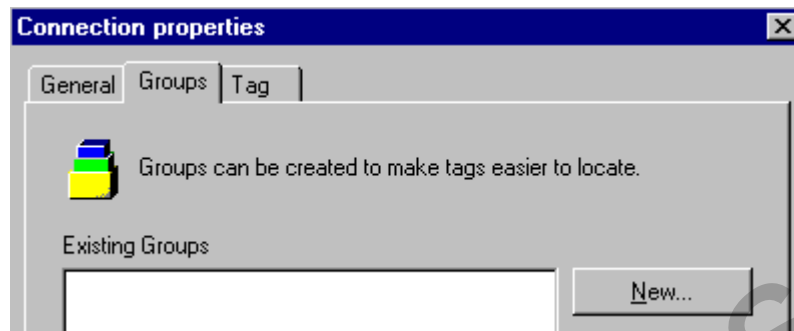

9. Switch to the "Groups" tab and click the "New..." button. This selection opens the "Properties of a tag group" dialog box in which you can create the new tag group.

### 4.8.3 Creating a Tag Group in an Existing Connection

#### How to Create a Tag Group in an Existing Connection:

1. In the Navigation Window, double-click on the project component "Tag Management". A list of all of the installed communication drivers is then displayed.
2. In the Navigation Window, double-click on the desired communication driver. This action opens up a list of all available channel units.
3. Double click on the desired channel unit to view a list of all available logical connections.
4. Select the desired logical connection and click the right mouse button.
5. In the pop-up menu that then appears, select the "New Group..." menu item. This selection opens the "Tag Group Properties" dialog box in which you can create new tag groups.

### 4.8.4 Cutting, Copying, or Deleting Tag Groups

#### How to Cut, Copy, or Delete One or More Tag Groups in an Existing Logical Connection:

##### Note:

The task sequence for cutting, copying, or deleting is the same for all tag groups.

1. In the Navigation Window, double-click on the project component "Tag Management". A list of all of the installed communication drivers is then displayed.
2. In the Navigation Window, double-click on the desired communication driver. This action opens up a list of all available channel units.
3. Double-click on the desired channel unit to view a list of all available logical connections.



4. Select the desired logical connection in the project navigation window. The data window then displays all the configured tags and tag groups.
5. Select the tag groups and click the right mouse button.

---

**Note:**

You can select tag groups using either of the two procedures described below.

Select the first tag group. Click the left mouse button. Press the <Ctrl> key and hold it down. Then select the next tag and click the left mouse button on each one. When all of the tags you want are selected, release the <Ctrl> key.

Select the first tag group. Click the left mouse button. Press the <Shift> key and hold it down. Then select the next tag group and click the left mouse button on each one. When all of the tag groups you want are selected, release the <Shift> key.

---

6. In the pop-up menu that appears, select the menu item you want, i.e. "Cut", "Copy" or "Delete".

**If you want to paste one more cut or copied tag groups:**

7. Select the target area to which you want to copy the selected tag groups.
8. Click the right mouse button in the data window.
9. In the pop-up menu that then appears, select the "Paste" menu item.
10. This action copies all of the selected tag groups to the target area. You must be aware of the following in this copy procedure:
  - Each of the copied tag groups and their tags receive a sequential number as shown in the following examples.
  - The "BinVarGroupS5TF" tag group is renamed "BinVarGroupS5TF\_1" after it is copied.
  - The "BinVarGruppeS5TF\_1" tag group is renamed "BinVarGruppeS5TF\_2" after it is copied.
  - The "BinVarS5TF" tag that may be located in a tag group is renamed "BinVarS5TF\_1" after it is copied.
  - The "BinVarS5TF\_1" tag that may be located in a tag group is renamed "BinVarS5TF\_2" after it is copied.
  - The "BinVarS5TF\_DB70" tag that may be located in a tag group is renamed "BinVarS5TF\_DB71" after it is copied.

**If You Want to Delete One or More Tags:**

11. The "Delete nnn Object(s)" window appears if you select the "Delete" pop-up menu item. Click the "Yes" button in this window. The selected tag groups with the tags contained in them are deleted (nnn is the number of selected objects).

## 4.8.5 "Properties of tag group" Dialog

### Note:

The number of tabs depends on the action being executed. If you are creating a new group, only the "General" tab appears. If you are editing the properties of an existing tag group, a dialog appears with the "General" and "Tag" tabs.

The dialog box contains one or two tabs with the following contents:

Tab	Contents
General	You can create a new tag group or edit the name of an existing tag group on the "General" tab.
Tag	You can delete a tag or create a new tag on the "Tag" tab.

### "General" Tab

The individual boxes have the following meaning:

Box Name	Meaning
Name	Unique name of the tag group. If you do not assign a unique name, an error message appears.
Number of Tags	Number of tags assigned to the tag group. You cannot edit this box.

### Message Box for a Name Match:

If the name you selected for the tag group already exists, the following dialog appears.

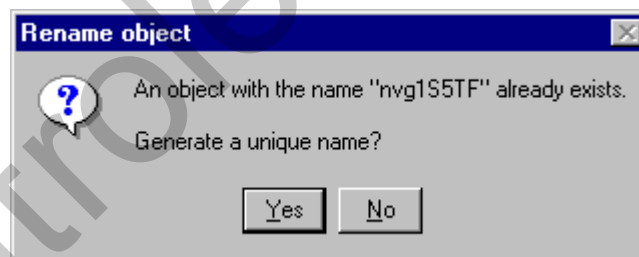

In this example, the WinCC system has determined that the name "nvgS5TF" was already assigned to another tag group.

The individual buttons mean the following:

Button	Meaning
Yes	Click this button to have the WinCC system create a unique name.
No	Click this button to exit the dialog box without creating a new tag group.

## "Tag" Tab

The individual areas have the following meaning:

Box/Button	Meaning
Tags	All of the current tags in the tag group are listed in this box.
New	Use this button to add new tags to the current tag group. Selecting this button opens the "Tag properties" dialog.
Delete	Use this button to delete the selected tag.
Properties	Use this button to edit or view the properties of the current tag. Selecting this button opens the "Tag properties" dialog.

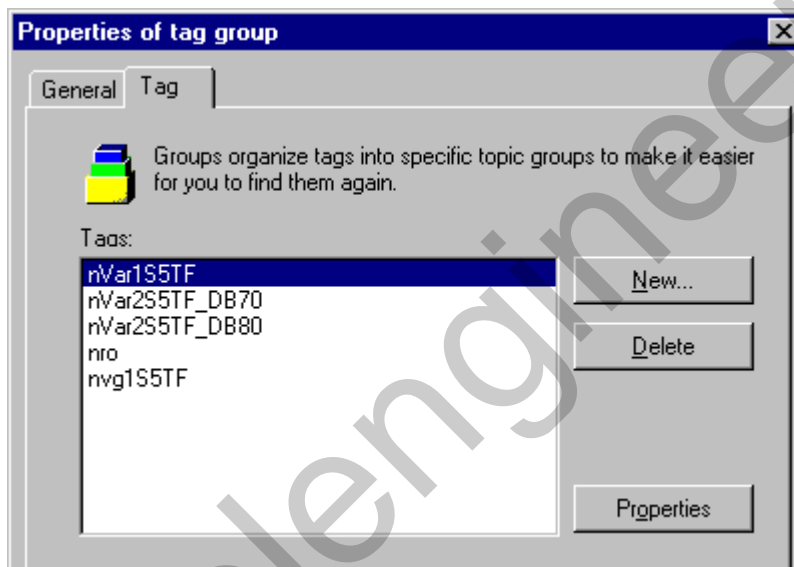

This examples shows you all of the tags in the current tag group.

## 4.9 Communications Drivers

### 4.9.1 General Information About the Communication Drivers

A communications driver is the interface between a subordinate PLC system and WinCC.

#### Which Communications Drivers Does the WinCC System Contain?

You can find out which communications drivers WinCC supports by looking in the "Channel DLL, Communication Drivers" manual.

The Channel DLL, Communications Drivers manual provides you with the following information:

- The prerequisites that you need to access process tags by means of a PLC.
- The general procedures for connecting to external tags.
- An introduction to the specific configuration of the Channel DLL (communications driver).

#### How To Install New Communications Drivers:

1. In the Navigation Window, click the right mouse button on the project component "Tag Management"  
or  
Click the right mouse button on an empty screen area in the data window.
2. In the pop-up menu, select the "Add New Driver..." menu item. The "Open the communication driver" dialog then opens.

#### The Pop-Up Menu of the Communication Drivers Contains the Following Items:

Menu Item	Meaning
Find...	Use this menu item to set and start a search action within the entire WinCC system.
Delete	Delete the selected communication driver.
Properties	View the properties of the selected communication driver.

## 4.9.2 Properties of a Communication Driver

### How to View the Properties of a Communication Driver:

#### Note:

You can only view the properties of a communications driver. You cannot edit these values.

1. In the Navigation Window, double click on the project component "Tag Management". You then receive a list of all of the installed communication drivers.
2. From the list of available communications drivers, select the communication driver whose parameters you want to view.
3. Open the corresponding pop-up menu.
4. Select the "Properties" menu item.

This selection opens a window entitled "Communication driver properties" where you can view the current values of the selected driver.

#### Structure of the "General" Tab:

You can only view the "General" tab. The following areas are displayed in this tab:

Field	Value/Meaning
	The name of the channel file is displayed here (for example, SIMATIC S5 ETHERNET TF).
Type	The type of communications driver is displayed here. The default display is Channel DLL.
Path	The name of the channel file is displayed here (for example, SIMATIC S5 ETHERNET TF.CHN).
Size	The size of the channel DLL is displayed here. The size of the channel DLL is displayed in kilobytes and bytes (for example, 135 KB (138240 BYTE)).
Units	The number of channel units in the channel file is displayed here (for example, the SIMATIC S5 ETHERNET TF.CHN channel DLL contains 2 units).

### 4.9.3 Accepting a New Communication Driver

#### How to Connect a Communication Driver to Your Project Management:

1. In the Navigation Window, click the right mouse button on the project component "Tag Management"  
or  
Click the right mouse button on an empty screen area in the data window.
2. In the pop-up that then appears, select the "Add New Driver..." menu item.
3. This selection opens a dialog which lists all of the channel files currently available to you. The standard file extension for the channel files is "\*.CHN".
4. Use either of the following steps to select the communications driver you want to connect to your project:

Double-click on the file name to copy the file to your project management or select the file you want to connect. This selection transfers the file name to the "File Name" input box. Then, you click the "Open" button to transfer the selected communication driver to your project management. The selected communication driver is transferred to your project management.

#### Error Message at an Attempt to Reload an Already Installed Communication Driver:

When you attempt to connect an already installed "SIMATIC S5 ETHERNET TF.CHN" communication driver to your project, a message window appears to let you know that the communication driver is already installed. Each communications driver can only be installed once.

### 4.9.4 Deleting a Communication Driver

If you want to delete a communications driver, you must proceed as follows:

1. In the data window, select the object you want to delete.
2. Use the right mouse button to open the corresponding pop-up menu and select "Delete".
3. In the "Delete an object" dialog that then appears, click on the "Yes" button. The selected object, any sub-objects it may contain, and all of the values contained in them are deleted.

## 4.9.5 Channel Unit

### 4.9.5.1 General Information about a Channel Unit

Each WinCC channel represents accessing of a specific type of remote PLC parameter by means of a specific report (e.g. with the aid of the channel SIMATIC S5 Ethernet TF, a SIMATIC S5 is accessed using the report TF). A communication driver can support several channel units of the same type. For example, the SIMATIC S5 Ethernet TF channel DLL can be driven with a SINEC-H1 unit (CP1413) as well as with a SINEC-L2unit (CP5412), in some cases at the same time. The WinCC data manager requests process values at run time from the remote PLC through the logical connection. The channel unit carries out the communication steps necessary for requesting the process values by means of the channel-specific connection and thus provides the WinCC data manager with process values. The data which are read in are stored as a process image in the RAM of your computer. All WinCC components access this process image. A channel unit is linked to the communication driver and therefore cannot be deleted or installed separately. Logical connections, tag groups, and tags can be assigned to a channel unit.

#### How to Open the Pop-Up Menu of the Channel Unit:

1. In the Project Navigation Window, double-click on the project component "Tag Management". A list of all of the installed communication drivers is then displayed.
2. In the Project Navigation Window or the data window, click the right mouse button on the channel unit for which you want to open the pop-up menu.
3. A corresponding pop-up menu appears. The structure of the menus can be different.

#### What Does the Pop-Up Menu of the Channel Unit Contain?

Menu Item	Meaning
New Driver Connection...	Use this menu item to set up a new logical connection.
System Parameter	Use this menu item to open the dialog for the system parameters of the channel unit, for example, bus parameters or device names. This menu item is not supported by all of the channel units.
Find...	Use this menu item to set and start a search action within the entire WinCC system.
Paste	This menu item is not available for a channel unit.
Properties	Use this menu item to view or edit the properties of the selected channel unit.

#### 4.9.5.2 "System parameters" Dialog

The structure of the "System parameters" dialog can differ from channel unit to channel unit. This dialog can be made up of one or more tabs whose structure depends on the channel unit used. System parameters can be set for the channel units of the "SIMATIC S5 Ethernet Layer 4" communication driver.

##### How to View/Edit the System Parameters of a Channel Unit:

1. In the Project Navigation Window, double-click on the "Tag Management" project component. This action provides a list of all of the installed communication drivers and internal tags.
2. In the Project Navigation Window, double-click on the desired communication driver. This action opens up a list of all available channel units.
3. Select the desired channel unit and click the right mouse button.
4. In the pop-up menu that appears, select the "System Parameter" menu item.
5. The "System parameters" dialog opens. In this dialog, you can edit or view the system parameters of the selected channel unit.



### 4.9.5.3 System Parameters for the "SIMATIC S5 Ethernet Layer 4" Communication Driver

#### Device Names Tab:

The "System parameters" dialog consists of 2 tabs, "Device Names" and "Transport Parameters". You can affect the values in the tabs by means of the following boxes:

Field	Value/Meaning
Change Names	You can change the device name displayed in bold and make it fit your current needs. The device name corresponds to the name of the network software.

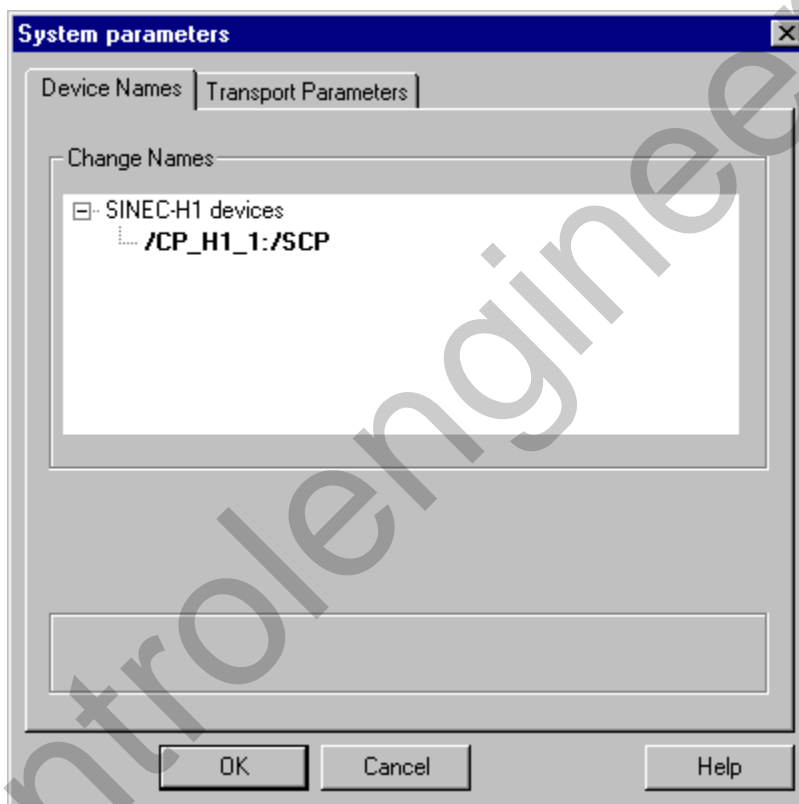

This example shows the system parameters of a **SIMATIC S5 Ethernet Layer 4** communication driver ("Device Names" tab).

### Transport Parameters Tab:

You can affect the values of the "Transport Parameters" tab by means of the following boxes:

Field	Value/Meaning
PDU Size	Here you can enter the maximum length of a data package to be transmitted. You can use one of the following values: 512 1024 2048 4096
Setup Attempts	Set the maximum number of setup attempts. If you select the "Infinite" option button, constant attempts will be made to set up the connection without an end.
Duration of Send Repetitions	Set the maximum number of repetition attempts for an unacknowledged data package. If you select the "Infinite" option button, an unacknowledged data package will repeat permanently.
Job Management	Under "Acknowledgement Time", specify the time to wait for an answer from the remote PLC.

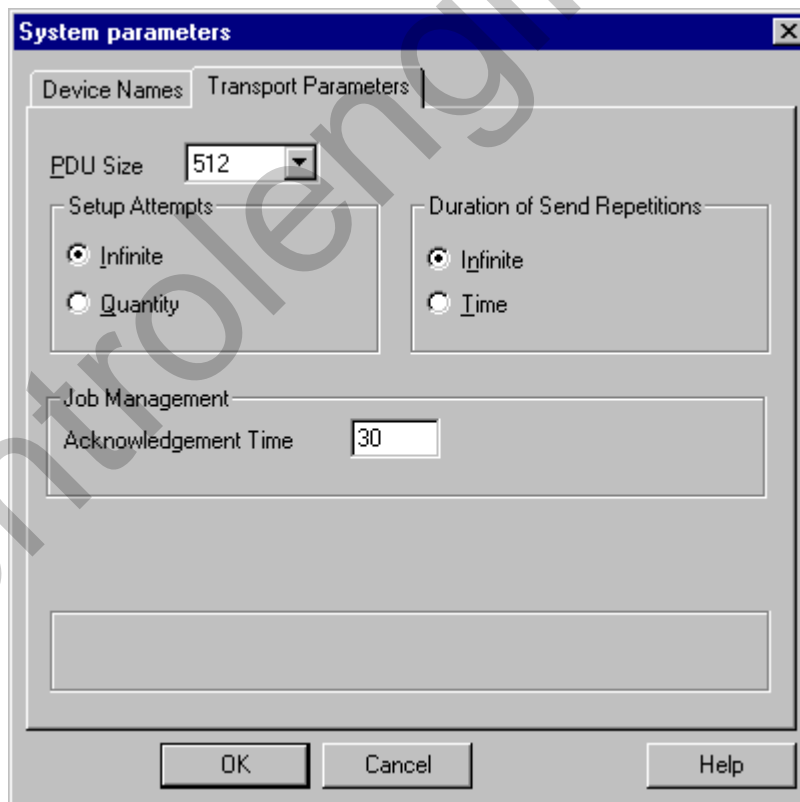

This example displays the system parameters of a SIMATIC S5 Ethernet Layer 4 communication driver ("Transport Parameters" tab).

#### 4.9.5.4 "Channel unit properties" Dialog

The dialog contains two tabs with the following contents:

Tab	Contents
Connections	Create new connections and edit existing connections in the "Connections" tab.
General	Enter general properties that affect the logical connection in the "General" tab.

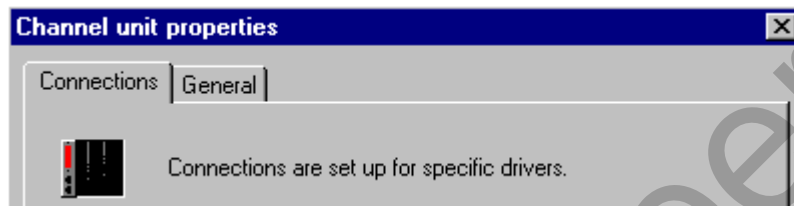

#### "Connections" Tab

Select the logical connection you want to edit in the "Connections" tab.

- Use the "New" button to create a new logical connection.
- Use the "Delete" button to delete the selected logical connection.
- Use the "Properties" button to edit the properties of the selected logical connection.

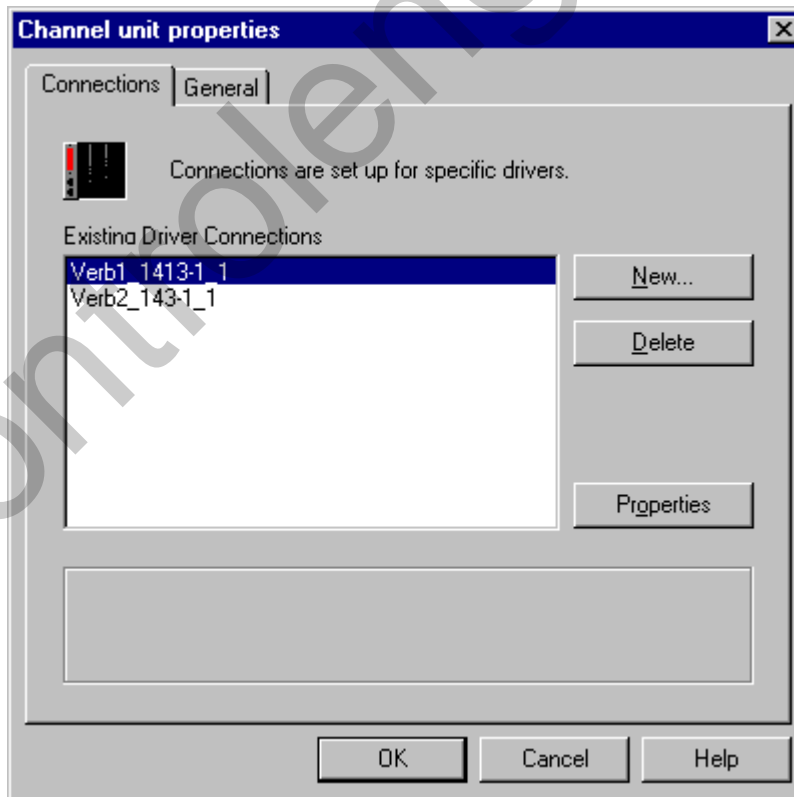

### "General" Tab

Click on the "General" tab in the selected channel unit.

All of the properties of the selected channel unit appear. You can determine what the current channel unit is in the "Name" box.

#### Note:

You can only view the boxes in the "General" tab. These boxes show you which functions are supported by the channel unit and which ones are not. All active functions are designated by the  icon.

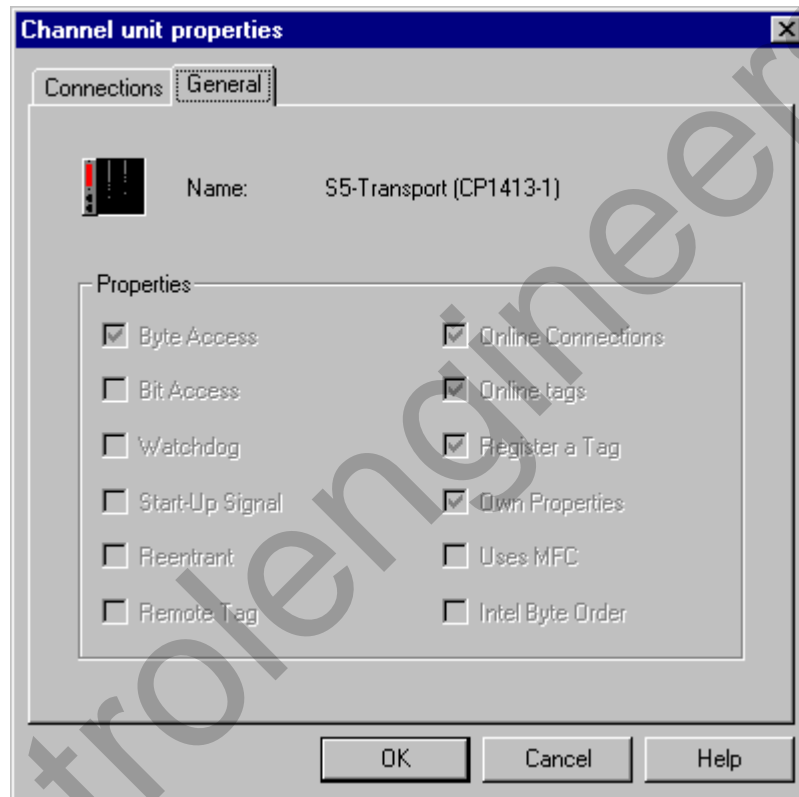

Box Name	Meaning
Byte Access	A channel unit uses this property bit to determine if it has write access to the remote PLC. Writing to byte addresses means that the low byte of a word can be written without changing the high byte and vice versa.
Bit Access	A channel unit uses this property bit to determine if it has write access to bits. Writing bits means that a bit can be written to the memory range of the remote PLC without changing other bits.
Watchdog	A channel unit uses this property bit to determine if it executes its own watchdog monitoring. When the unit executes its own watchdog monitoring, it guarantees that the communication channel and the remote PLC are ready to communicate.

Box Name	Meaning
Start-Up Signal	A channel unit uses this property bit to determine if it automatically shares a start-up with the remote PLC. When an automatic start-up signal is selected, a channel shares its start-up with the remote PLC.
Reentrant	A channel unit uses this property bit to determine if its API functions are reentrant. A reentrant channel unit guarantees that its API functions can be called simultaneously by multiple threads of the WinCC data manager. If synchronization of the threads by means of operating system resources (such as semaphores or events) is necessary, the channel unit performs the synchronization. If the channel unit is not reentrant, the WinCC data manager synchronizes its threads.
Remote Tag	A channel unit uses this property bit to determine if it can access tags that are configured in the remote PLC. Tags that are configured by the remote PLC are identified by means of their names. The channel unit is capable of providing these names to the WinCC data manager when necessary.
Online Connections	A channel unit uses this property bit to determine if it can register additional logical connections if it was started in runtime mode. If a channel unit is started in RUNTIME mode and if this property bit is set, newly configured logical connections are registered immediately with the channel unit by means of the WinCC data manager. The channel unit loads the corresponding specific connection so that the logical connection is capable of operating immediately.
Online tags	A channel unit uses this property bit to determine if it can register additional WinCC tags at runtime.
Register a Tag	A channel unit uses this property bit to determine if it wants WinCC tags that are assigned to the logical connection of the unit to be registered during the initialization phase.
Own Properties	A channel unit uses this property bit to determine if it contains its own configuration of internal configuration values.
Uses MFC	A channel unit uses this property bit to determine if the channel-specific dialogs are implemented by means of Visual C++ and MFC or standard Windows tools.
Intel Byte Order	A channel unit uses this property bit to determine if process data in the remote PLC are in INTEL byte order.

## 4.9.6 Connection

### 4.9.6.1 General Information About a Connection

A logical connection describes the interface between the automation system and the WinCC data manager.

#### How to Create a New Logical Connection:

1. In the Project Navigation Window, double-click on the project component "Tag Management". A list of all of the installed communication drivers is then displayed.
2. In the Navigation Window, double-click on the desired communication driver. This action opens up a list of all available channel units.
3. Select the desired channel unit and click the right mouse button.
4. In the pop-up menu that appears, select the "New Driver Connection..." menu item. This selection opens the "Connection properties" dialog. Here you can load new tag groups and tags, and set the name of the new connection.

### 4.9.6.2 "Connection properties" Dialog

The dialog consists of at least four tabs with the following contents:

Tab	Contents
General	Enter general properties that affect the logical connection in the "General" tab.
Groups	Create tag groups in the "Groups" tab. Groups can be used for a better organization of tags.
Tag	Create tag groups in the Tag" tab. These tags are not assigned to a group.
Connection	The structure of this tab depends on the communication driver used. There can be different "Connection" tabs for each communication driver. Even the name of the tab can be different.

### "General" Tab

In the selected channel unit, click on the "General" tab.

The system displays the general properties of the selected logical connection.

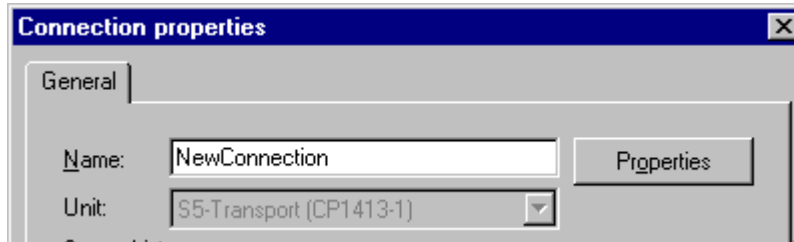

Field	Value/Meaning
Name	Enter the name of the logical connection here. This name must NOT have been used within your project at this point. The standard name provided is "New Connection" which you must replace with a unique name.
Unit	Select the desired channel unit in this box.
Server List	Sets the location of the data source for each client. You determine the location of the data source for the run-time module with the sequence of the individual servers within the server list. You determine the location of the data source for the run-time module with the sequence of the individual servers within the server list. Use the "Up" and "Down" buttons to change the sequence of the servers in the server list. Use the "Add" button to add a new server to the current server list. Use the "Remove" button to delete a server from the current server list.

### "Groups" Tab

A group combines all of the tags which have a logical connection to each other. For example, you can create the following groups:

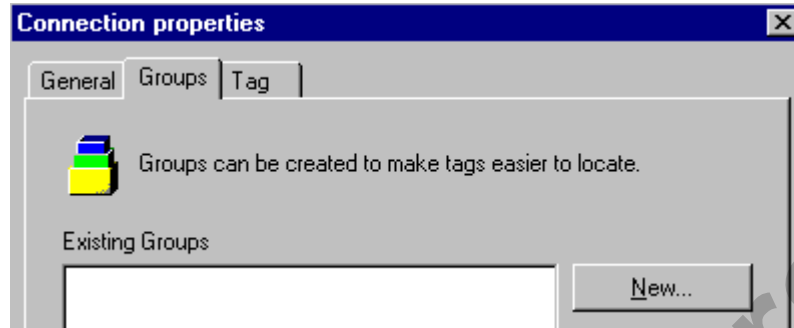

Group	Meaning
CPU	This group combines all of the tags that access the same CPU.
Furnace	This group combines all of the tags that access a furnace.
Presses	This group combines all of the tags that access the presses.
Digital I/O	This group combines all of the tags that access all the digital I/Os.
Analog I/O	This group combines all of the tags that access all the analog I/Os.

This table should serve only as an example.

#### You Can Execute the Following Actions within the "Groups" Tab:

1. Use the "New..." button to create a new tag group.
2. Use the "Delete" button to delete the selected tag group.
3. Use the "Properties" button to edit the properties of the selected tag group.



## "Tag" Tab

WinCC tags are the central element for accessing process values. Within a WinCC project, they receive a unique name and a data type, among other things. A logical connection is assigned to a WinCC tag. This connection determines which channel delivers the process values to the tags using which connection. The WinCC tags are stored in a project-wide data base. When a WinCC machine starts, all of the tags belonging to a project are loaded and the corresponding run-time structures are set up.

### You Can Execute the Following Actions Within the "Tag" Tab:

1. Use the "New..." button to create a new tag.
2. Use the "Delete" button to delete the selected tag.
3. Use the "Properties" button to edit the properties of the selected tag.

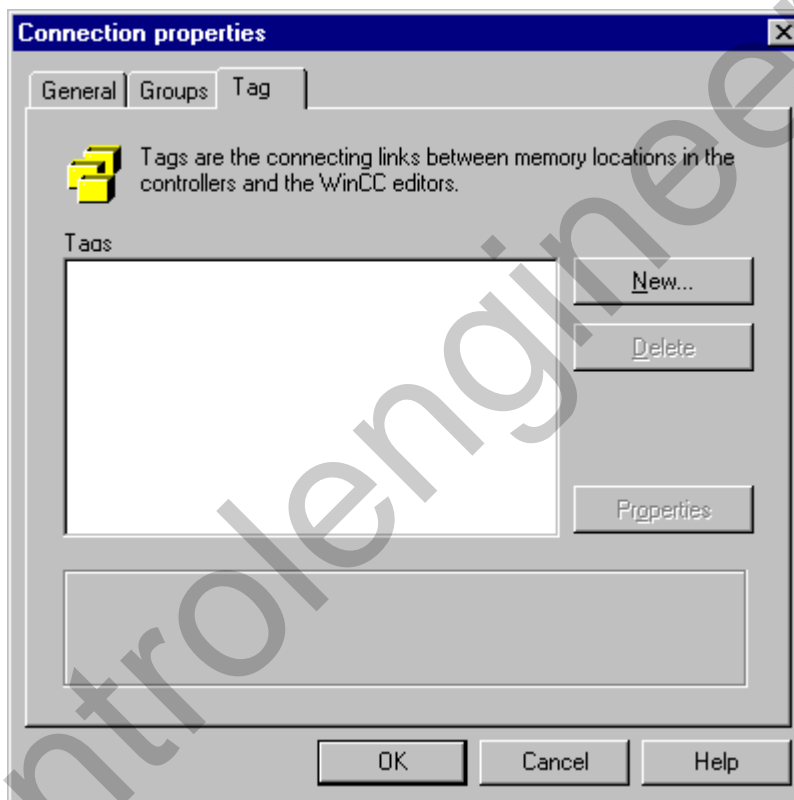

### 4.9.6.3 Channel-Specific Tab

The structure of the channel-specific tab can be different from channel unit to channel unit. Not only are the contents of the tabs sometimes different, even the name of the tab can change.

You can find additional information about the structure of this or other tabs in the "Channel DLL, Communication Drivers" manual.

## 5 Editors of the WinCC Explorer

### 5.1 "Alarm Logging" Editor

**Alarm Logging Offers the Following Features:**

- Extensive information about alarm and operating states
- Early recognition of critical situations
- Avoidance and reduction of down time
- Increase in product quality

**How to Open Alarm Logging:**

### 5.2 "User Administrator" Editor

**The User Administrator Offers the Following Features:**

- Assigns and manages access authorization
- Protection of data from unauthorized access

### 5.3 "CrossReference" Editor

**The CrossReference Editor Offers the Following Features:**

- Finding all the usage locations of specific objects
- Direct jumping to the usage locations of an object in order to change or delete them ("usage location jump" function)
- Changing the name of tags by means of the "rewire" function without causing inconsistencies in the configuration.

## 5.4 "Text Library" Editor

The Text Library Offers the Following Features:

- Assigning user texts to individual messages within "Alarm Logging".
- The ability to prepare user texts for different languages

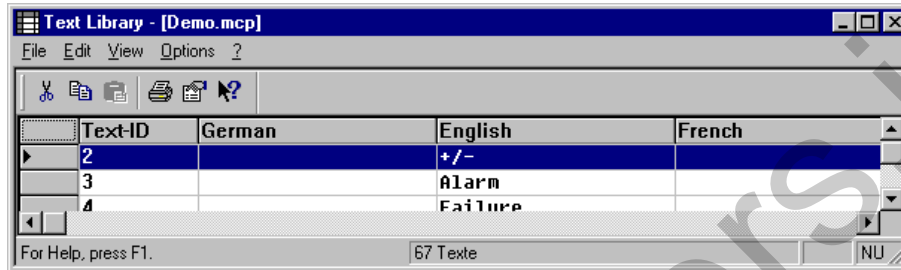

This picture shows you the languages installed as defaults (German and English) in the Text Library.

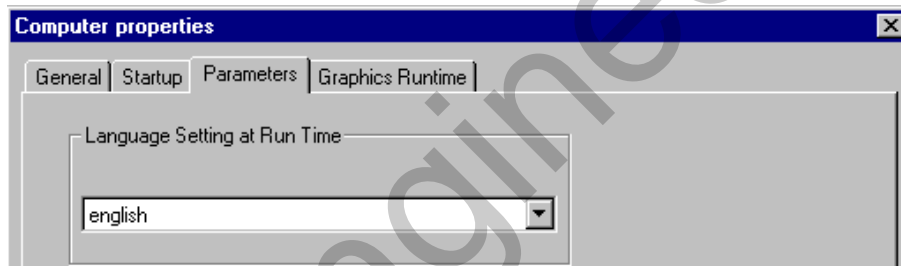

Use the *Properties of a Computer* dialog to determine which of the configured languages should be used in RUNTIME mode.

## 5.5 "Report Designer" Editor

**General Information about the Report Designer:**

WinCC offers an integrated report system with which you can create reports about user data, current and archived process values, current and archived messages, and your own system documentation.

**The Report Designer Offers the Following Features:**

- Convenient and simple user interface with tool and graphic palettes
- Support of different reporting methods
- Support of the output media supported by Windows
- Page-by-page display of reports that are already archived
- Support of the OLE 2.0 interface
- A 32-bit application that can run under Windows NT
- Standard system layouts and print jobs
- Its own on-line help for Layout and for Line printer layout

## 5.6 "Global Script" Editor

Global script is the general term for C functions and actions that can be used throughout a project or even in other projects.

### The Global Script Editor Offers the Following Features:

- The capability to create C functions and actions
- The capability to implement these C functions and actions through the entire project or even in other projects

---

### Note:

If you want to view or edit specific "Global Script," you can call them up directly from the WinCC Explorer. In the project navigation window, you select the folder with the desired script and open the pop-up menu. In the pop-up menu, select the "Open..." menu item. The "Global Script" module is then loaded with the selected script.

---

## 5.7 "Tag Logging" Editor

### Tag Logging Offers the Following Features:

- Optimum and efficient utilization of the plant
- Transparency of the operating procedures
- Increase in productivity
- Increase in product quality
- Optimized delay cycles

## 5.8 "Graphics Designer" Editor

### The Graphics Designer Offers the Following Features:

- Easy-to-use, simple interface that maintains the Windows operating philosophy
- Streamlined configuration with an integrated icon library
- Open interfaces for importing graphics and supporting the OLE 2.0 interface
- Configurable dynamic behavior of picture objects with support from an assistant (Dynamic Wizard)
- Links to additional functions by means of powerful script configuration
- Links to graphic objects that you can create yourself

### Creating a New Picture

The following steps are necessary for creating a new picture.

#### How to Create a New Picture:

1. In the Project Navigation Window, click on the "Graphics Designer" editor.
2. Click the right mouse button on the "Graphics Designer" editor.
3. In the pop-up menu that appears, select the "Open Picture" menu item.
4. This selection starts the "Graphics Designer" and you can edit the selected picture.

### Opening an existing picture

The following steps are necessary for opening an existing picture.

#### How to Open an Existing Picture:

1. In the Project Navigation Window, click on the "Graphics Designer" editor.
2. In the data window, select the desired picture and click the right mouse button. In the pop-up menu that appears, select the "Open Picture" menu item. This selection starts the "Graphics Designer" and you can edit the selected picture.

or

In the data window, double-click on the desired picture. This action starts the "Graphics Designer" and you can edit the selected picture.

## Editing the Properties of the Graphics Runtime

The following steps are necessary for editing the properties of a picture in Graphics Runtime.

### How to Edit the Properties of a picture in "Graphics Runtime":

1. In the Project Navigation Window, double-click on the "Computer" project component to view a list of all of the configured computers.
2. In the data window, click the right mouse button on the computer whose properties you want to edit.
3. In the pop-up menu that then appears, select the "Properties" menu item.
4. This selection opens the "Computer properties" dialog. In this dialog, select the "Graphics Runtime" tab. In which you can set the behavior of the selected start picture in RUNTIME mode.

## Defining a Picture as a Start Picture

The following steps are necessary for defining a picture as a start picture in Graphics Runtime.

### How to Define a Picture as a Start Picture in Graphics Runtime:

1. In the Project Navigation Window, click on the "Graphics Designer" editor.
2. In the data window, click the right mouse button on a picture you want to define as a start picture in Graphics Runtime.
3. The picture selected is now entered as a start picture in the "Graphics Runtime" tab of the "Computer Properties" dialog and used as a start picture in runtime.

## Viewing the Properties of a Picture

The following steps are necessary for viewing the properties of a picture in the Graphics Designer.

- This dialog box provides the following information:
- A preview of the picture in the left half of the window
- Date and time when the picture was created
- Date and time when the last change was made
- Size of the PDL file in bytes
- Configured picture size in pixels (for example, 80\*155)
- Number of configured objects in the picture

### How to View the Properties of a Picture in the "Graphics Designer":

1. In the Project Navigation Window, click on the "Graphics Designer" editor.
2. In the data window, select the PDL file whose properties you want to view. Click the right mouse button .
3. In the pop-up menu that then appears, select the "Properties" menu item.
4. This selection opens the "nnn.PDL" dialog box (nnn stands for the file name). Use this dialog to view the properties of the selected picture.

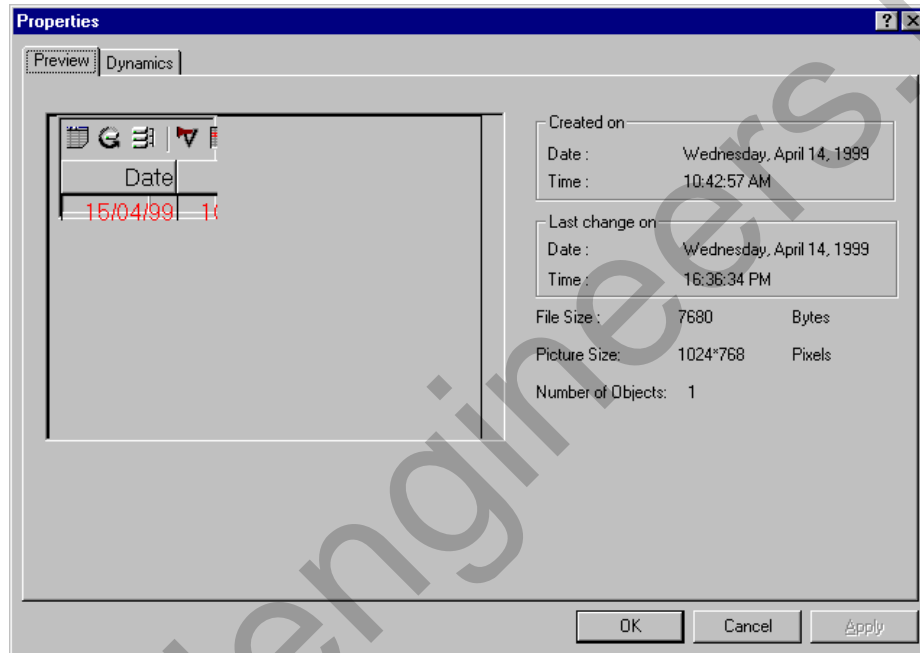

### Linking New Objects in the Graphics Designer

The following steps are necessary for editing the properties of the Graphics Designer.

#### How to Link New Objects in the "Graphics Designer":

1. In the Project Navigation Window, click on the "Graphics Designer" editor.
2. Click the right mouse button on the "Graphics Designer" editor.
3. In the pop-up menu that appears, select the "Graphic OLL." menu item.
4. This selection opens the "Object OLL" dialog. Use this dialog box to link new objects in the "Graphics Designer."





#### Purpose of the Dialog Box:

Use this dialog box to add additional objects to the "Graphics Designer". These objects expand the "Graphics Designer" by adding elements for visualizing a process. These additions can be text objects, button objects, or OLE objects.

**Note:**

There is a context-sensitive help in the "Object OLL" dialog box. Use the  button to activate this help function. If you have clicked on this button, the cursor changes to an arrow with a question mark attached. Select the area or button about which you want more information.

The dialog box is divided into three screen areas.  
 The individual areas and buttons have the following meaning:

Area/Button	Meaning
Available Graphic OLLs	All of the OLLs that are not yet connected to the "Graphics Designer" are listed here.
Selected Graphic OLLs	All of the OLLs that are already connected to the "Graphics Designer" are listed here. If you select an OLL from this area and then click on the "Preview" button, all of the objects of the selected OLL are displayed in the bottom of the window.
 	Use these buttons to move individual OLLs from the one area to the other.
 	Use these buttons to move all the OLLs in one area to the other area.
"Have Disk" button	If you click on this button, you can link additional OLL files. These files can be on a diskette, hard disk, or network. In this dialog, use the "Browse" button to access the "Graphic OLL" dialog box in which you can search for the required OLL files.

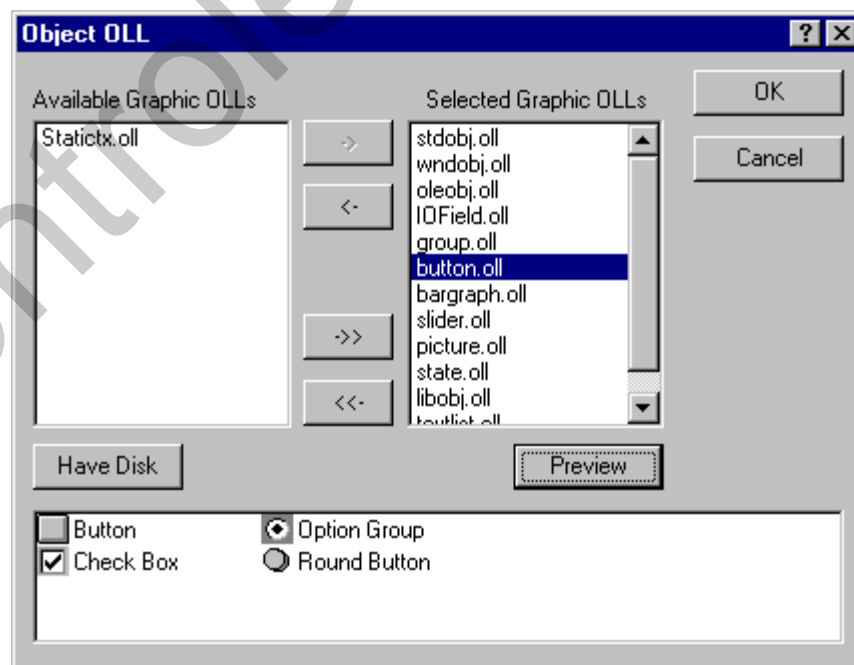



## Converting Pictures or Libraries

You can convert older pictures or libraries to the current format of the Graphics Designer. Use these options to not only convert pictures and libraries, but also compress existing ones.

### How to Convert Pictures or Libraries:

1. In the Project Navigation Window, click on the "Graphics Designer" editor.
2. Click the right mouse button on the "Graphics Designer" editor.
3. In the pop-up menu that appears, select the required menu item. You can activate one of the following menu items:
  - "Convert pictures"  
Use this command to convert all configured pictures.
  - "Convert global library"  
Use this command to convert the global library.
  - "Convert project library"  
Use this command to convert the project library.

---

### Note:

In Graphics Designer, use the "View" "Library" menu items to edit your current libraries.

---

## 5.9 Server Data

### 5.9.1 General Information

The Server Data function is used to create, delete, search for, and view packages. This is necessary in order to make the relevant data of a server available on a multi-client. The packages contain symbolic names of configuration-relevant data such as pictures, tags, messages, and archives. They can be created on the servers and loaded onto the multi-clients. As a result, the data of the server project are available on the multi-clients. The packages can be loaded in the configuration system (CS) and in runtime (RT).

### 5.9.2 Commands in the pop-up menu of the Server Data function

#### 5.9.2.1 Functions in a server project

The pop-up menu of the Server Data function varies according to the project type. The pop-up menu in a server project (multi-user system) contains the following commands:

Commands	Meaning
Create	With this command, data stored in the server project such as tags, messages, archives, and pictures are used to create a package. The created package is displayed in the data window of the Server Data function under ProjectName_ComputerName.pck. In the project folder, the package is stored in the subdirectory "\\local computer\Packages" under the file name: ProjectName_ComputerName.pck.
Delete	Use this command to open the "Delete Server Data" dialog. There, you can delete an existing package. This dialog window can also be opened by clicking the right mouse button on the created package in the data window.
Find	Use this command to open the "Find" dialog. The functionality of the dialog is identical to that of the WinCC Explorer, which is described in the Control Center manual.
Properties	The addressing of the server for the multi-client is set in the package properties on the server. It is not possible to edit the redundant computer on a WinCC server. Which redundant computer belongs to which physical computer can be determined using the Redundancy option.

## Server Properties

The addressing of the server for the multi-client is set in the package properties on the server.

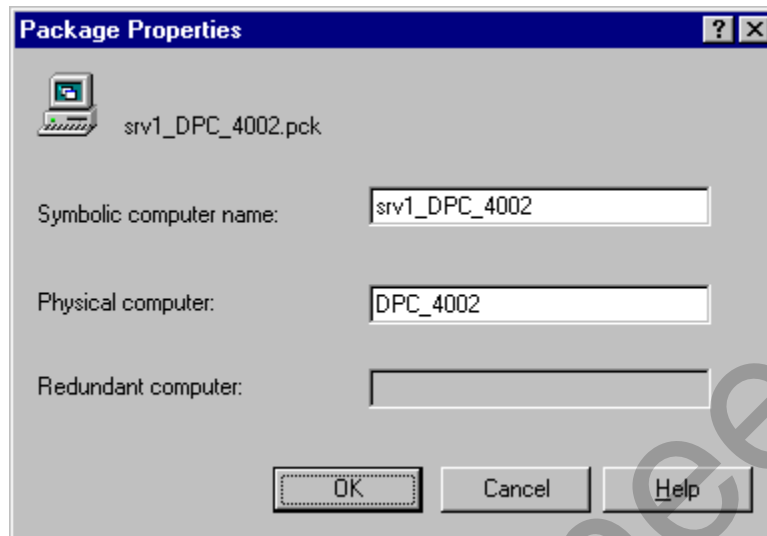

---

### Note:

It is not possible to edit the redundant computer on a WinCC server. Which redundant computer belongs to which physical computer can be configured using the Redundancy option.

---

### Symbolic computer name

The default symbolic computer name which is displayed is assembled as follows: ProjectName\_ComputerName. This symbolic name can be changed to meet your requirements.

### Physical computer name

The physical computer name corresponds to the computer name which was entered when the operating system was configured. It identifies the computer in the network. The computer name can be changed via the network properties of the operating system in the Identification tab.

### Redundant computer name

The redundant computer name corresponds to the computer name which was entered when the operating system of the redundant computer was configured. It identifies the redundant computer in a network. The computer name can be changed via the network properties of the operating system in the Identification tab.

### 5.9.2.2 Functions on Multi-Client

The following menu items are available for selection in the pop-up menu of the Server Data function on the Multi-Client (Multi-Client project type):

Command	Meaning
Load	Use this command to load packages from selected servers into the multi-client project.
Update	Use this command to load all packages which have already been loaded into the multi-client project.
Standard Server	Components that do not obtain their data from specific servers, i.e. the controls for displaying messages and process data, use the standard server which is set here.
New	Use this command to create a new package on a multi-client without the requirement that it be generated on the server and loaded into the multi-client. It is, however, absolutely necessary that the computer name of the server and the individual object names of tags, pictures, and archives be known, as no configuration support via a browser dialog is offered. In order to manually address a tag on the server, for example, the following syntax must be entered via the keyboard.  Symbolic computer name::Tag name; Symbolic computer name::Picture name; Symbolic computer name::Archive name\Tag name
Delete	Use this command to delete a package which is loaded into the project.
Find	Use this command to open the "Find" dialog. The function of the dialog is identical to that of the WinCC Explorer, which is described in the Control Center manual.
Properties	Use this command to set the standard server; with a redundant system, its redundant computer can also be set using this command.

## Loading Packages

To load a package into a multi-client project, select "Load" from the Server Data pop-up menu and set the search path to the memory location of the package in the server project. The default storage location for packages on the servers is `"..\ServerProjectName\ComputerName\Packages\ProjectName_ComputerName.pck"`. The package is then copied into the project folder of the multi-client under `"..\ProjectFolder\Package"`.

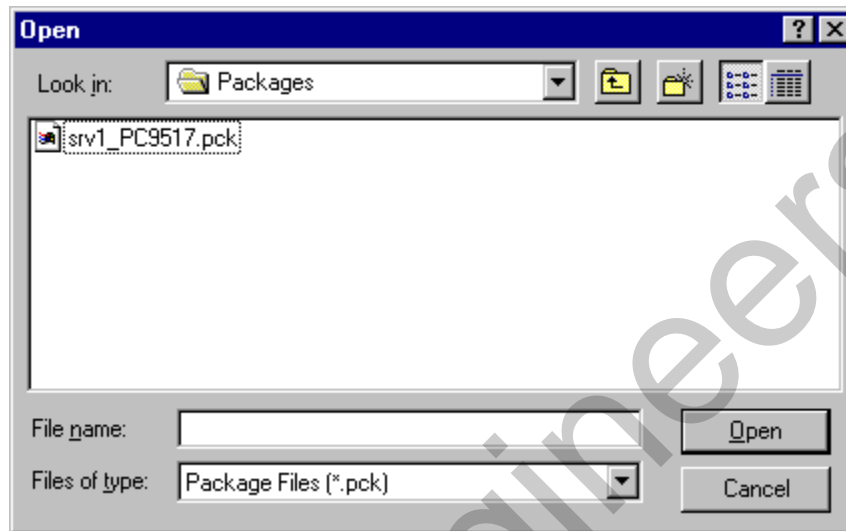

## Re-"Load" Package

If a package which has already been imported is to be reloaded into a multi-client project, perform the "Load" procedure again as previously described.

A check is performed to determine whether the symbolic computer name already exists. If no entry is yet present for this symbolic computer name, the package is accepted as new and displayed under the packages entry with the following information: "Symbolic computer name", configurable unit, file name, date of creation.

If an entry with the symbolic computer name from the package is already known, then if an attempt is made to load such a package again, the user is given the opportunity to interrupt the import, rename the symbolic computer, or to overwrite the existing symbolic computer name with these new data. The renamed package has no relation to a physical computer.

---

### Note:

The Server Data function "Update" is preferred to re-executing the "Load" function.

---

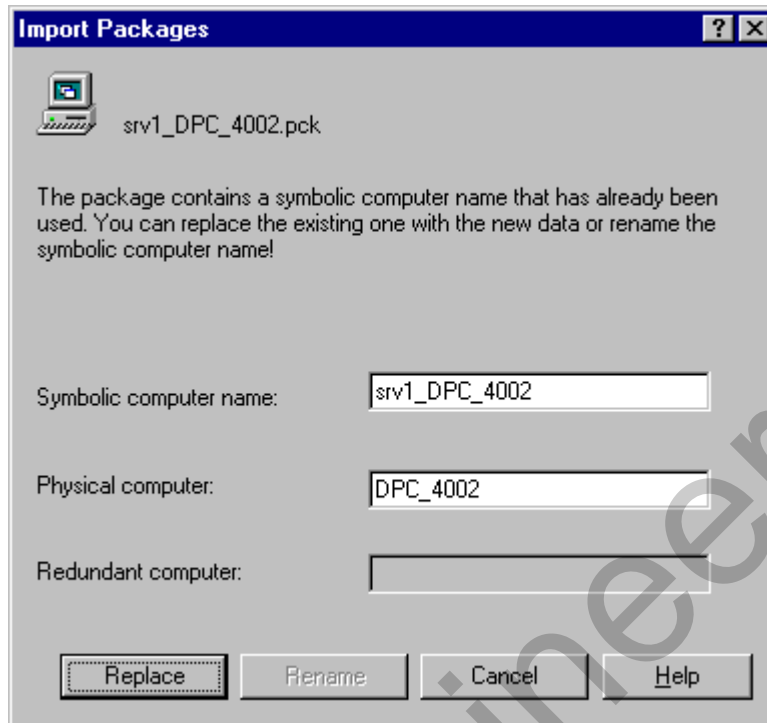

### Updating Packages

When updating packages, all packages located in the \ProjectFolder\Packages path are reloaded. This is accomplished by accessing via the network the various servers from which a package was loaded.

### Error While Updating the Server Data

If a server is not available while updating the packages, the "Update Server Data" dialog appears with the message: Error while updating the server data. In this case, you will be asked if you would like to update the local package. When updating the local package, no network access is made to the server on which this package was created.

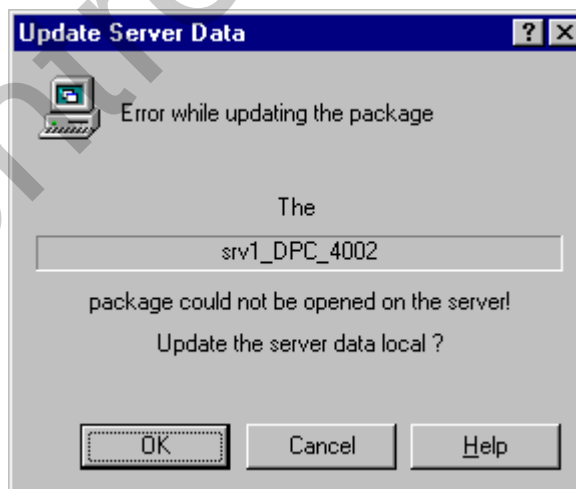

### Setting the Standard Server

Components that do not obtain their data from specific servers, i.e. the controls for displaying messages and process data, use the standard server which is set here. Use the opened "Standard Server" dialog to set the standard server for individual components such as pictures, tags, messages and archives.

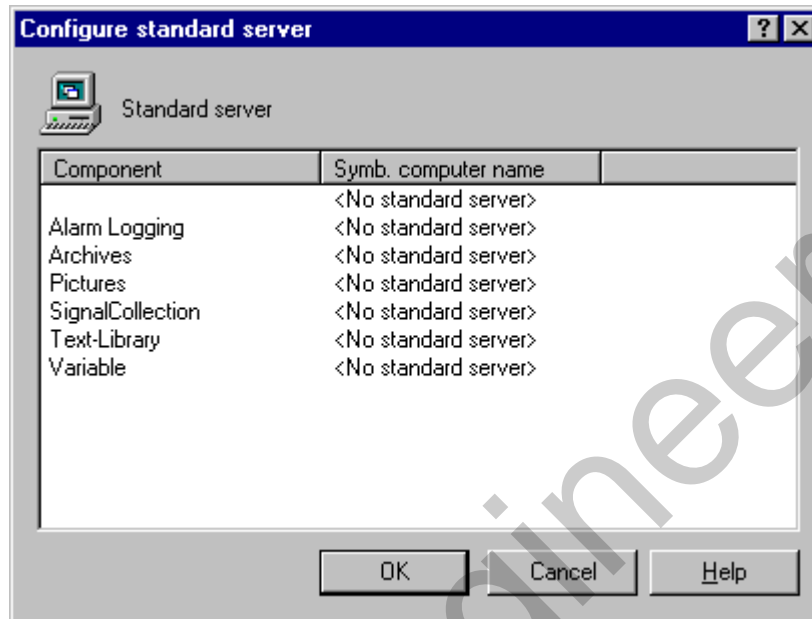

To set a standard server for one component, activate the corresponding entry for the component in the symbolic computer name column. The symbolic computer names for all packages loaded in the multi-client are listed.

---

#### Note:

A standard server can be selected only after the packages have been "Loaded" in a multi-client project.

---

## New Package

This command allows the experienced user to use the technology of packages and to use the options offered by a multi-client project without having to adhere to the usual sequence of steps: create packages, load packages, and update packages.

It is, however, absolutely necessary that the computer name of the server and the individual object names of tags, pictures, and archives be known, as no configuration support via a selection dialog is offered. In order to manually address a tag on the server, for example, the following syntax must be entered via the keyboard: Symbolic computer name::Tag name; Symbolic computer name::Picture name; Symbolic computer name::Archive name\Tag name

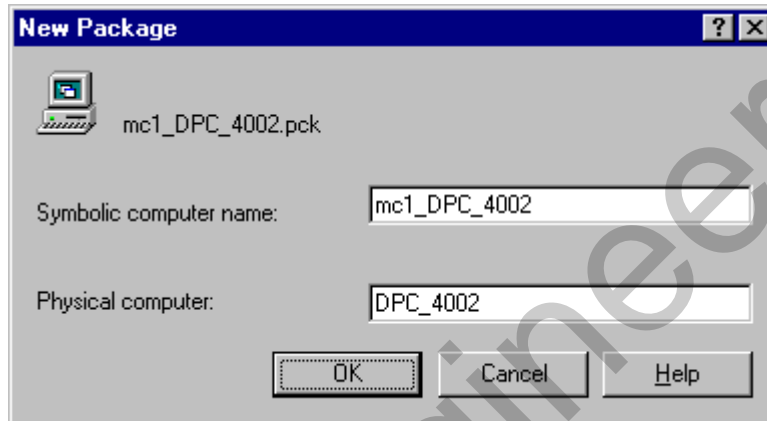

A package is created under \ProjectFolder\Package\ with this function as well.

If a new package is created on the multi-client via this dialog, the redundant computer cannot be edited, as no secure information about the installation of the Redundancy option is available without the information from an exported package.

In this case, the dialog has the following appearance:

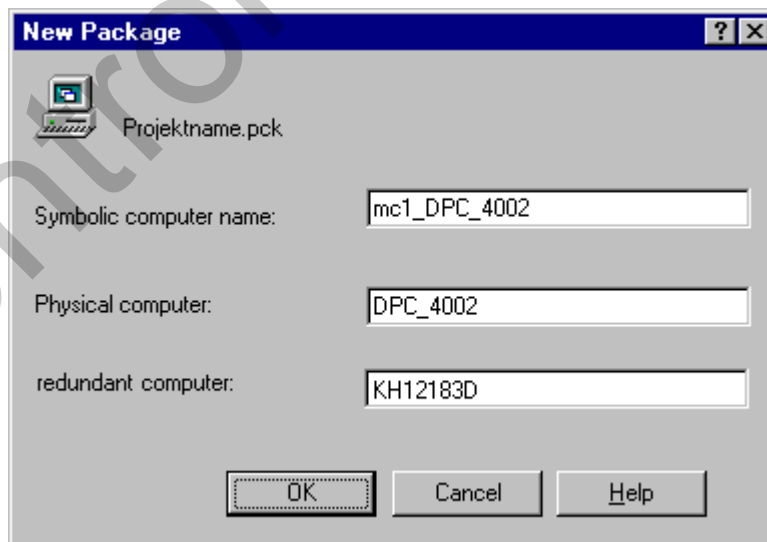



### Multi-Client Properties

Use this menu item to set a standard server; with a redundant system, its redundant computer can also be set using this command.

The "Physical computer name" box contains the configured standard server. It can be edited directly in this box. Moreover, the data for the assignment of the symbolic computer name to the physical computer name for all imported packages can also be configured under this menu item.

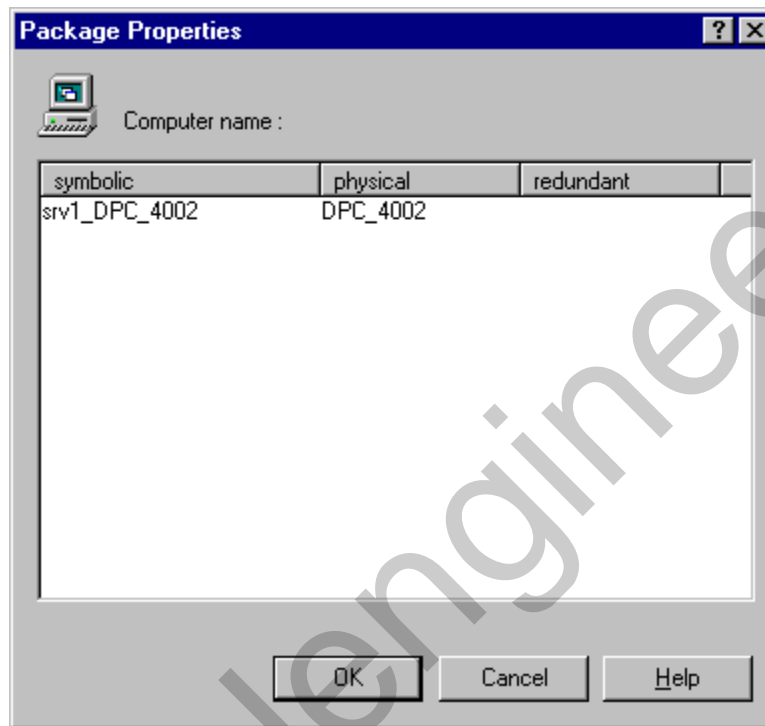

Only when the Redundancy option has been installed on a server the redundant server can also be directly edited in the "Redundant computer name" box.

---

#### Note:

If a package is created on the multi-client via the "New" Server Data function, no redundant computer can be edited, as no secure information about the installation of the Redundancy option is available without the information from a loaded package.

Changes which are performed while the system is in runtime take effect only after reactivating.

---

### 5.9.3 Selecting Message Servers

Messages are displayed with the help of the "WinCC Alarm Control", which is integrated in a Graphics Designer picture. In the properties of the control, the server from which the displayed messages originate is set in the "Style" tab.

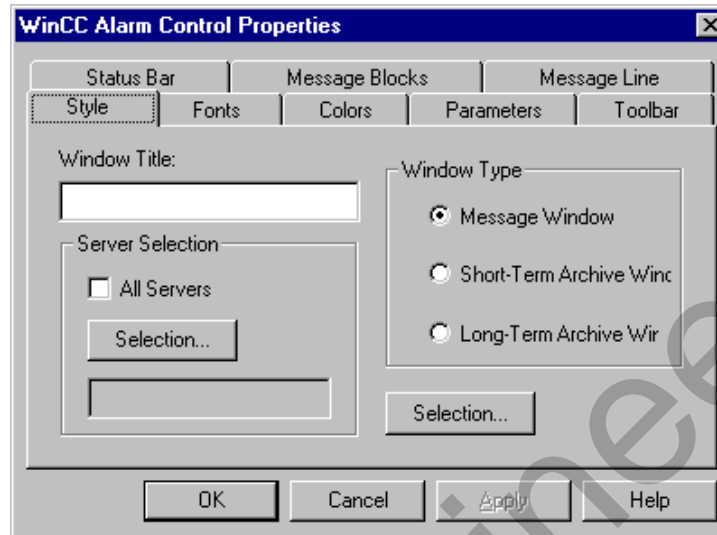

Use the "Selection" button to open the "Server Selection" dialog. Here, all servers are listed from which a package has already been loaded into the multi-client project.

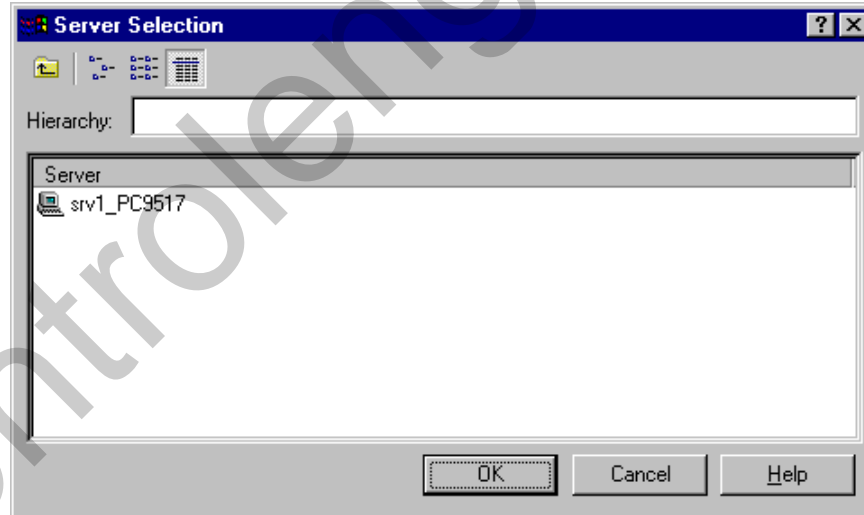

### 5.9.4 Selecting Process Tags

Process tags are displayed with the help of the "WinCC Trend or Table Control", which is integrated in a Graphics Designer picture. In the properties of the control, the server from which the displayed archives and tags originate is set in the "Elements" tab. The following procedure applies to the configuration of the WinCC Online Table Control and of the WinCC Online Trend Control.

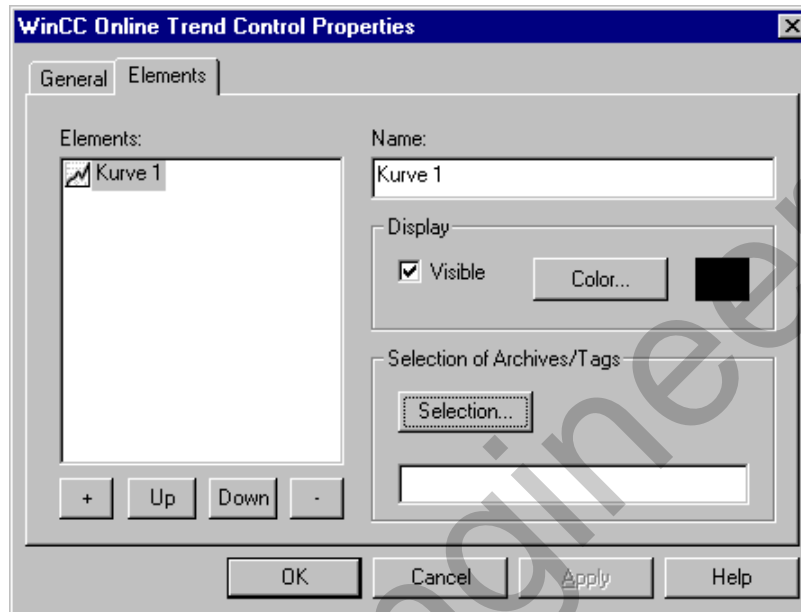

Use the "Selection" button to open the "Archive/Tag Selection" dialog.

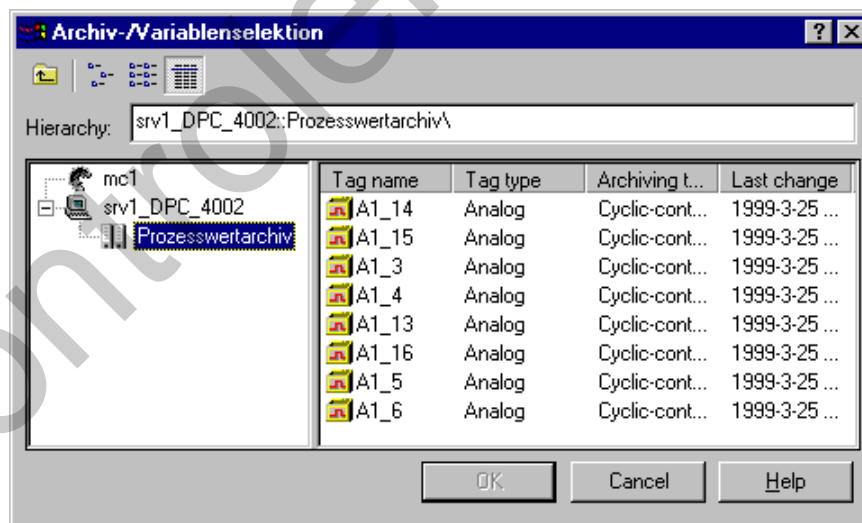

In the navigation box of the "Archive/Tag Selection" dialog, you can select the server from which packages are loaded and on which a process value archive was configured with tags.

**Note:**

If a required server is not contained in the server list, one of this server's packages must first be loaded using the "Load" Server Data function.

### 5.9.5 Selecting Server Pictures

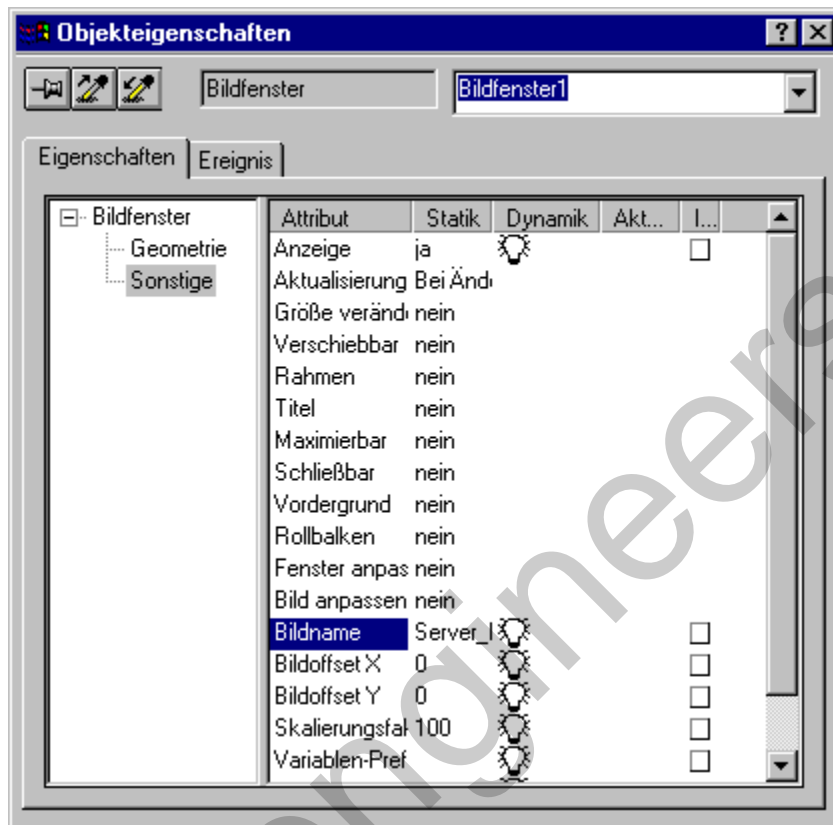

The name of the assigned server can be changed by means of double clicking on the "Picture Name" attribute.

#### Note

The update of the screen windows contained in a screen of a multi-client is not performed automatically after a lost connection to the server has been reestablished. The WinCC system does not provide connection monitoring on a screen window basis. It is therefore not possible for you to identify the current server status. However, you can check the status of the referenced server by evaluating the status of a server tag in an I/O field. You can also check the server status via a script, which continuously evaluates a server tag.

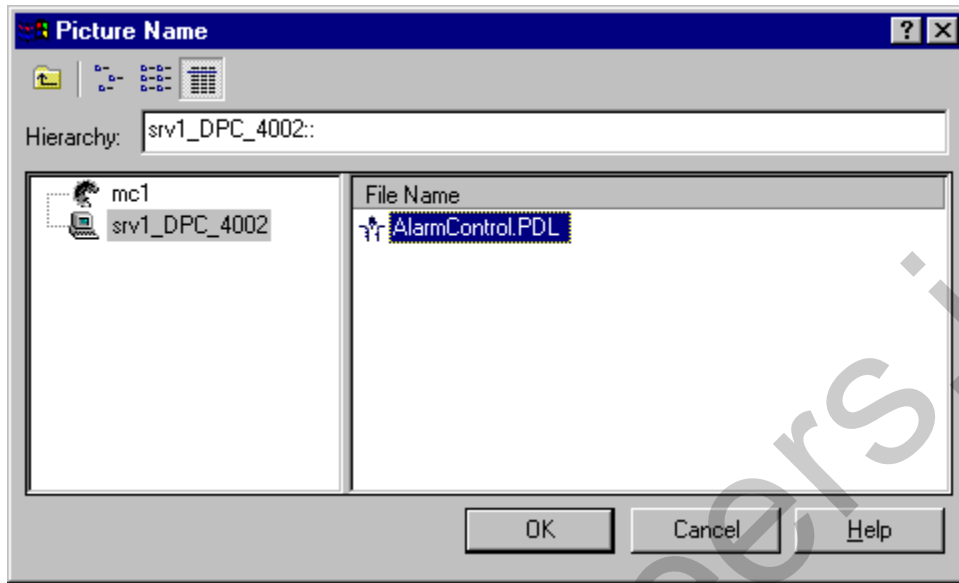

## 5.10 DDE-Server

### 5.10.1 General Information about the DDE-Server

- The WinCC DDE-server is an independent application for WinCC. It requires to be in runtime in order to assign the configured tags of a WinCC project to any DDE-clients. The DDE-server is only required for the data exchange through the network.
- The DDE-server is controlled by means of the "WinCC DDE-Server" dialog box. This dialog box is only visible, if the parameter "/v" has been indicated within the startup list of the computer. The dialog box will be opened while runtime is activated.

#### Structure of the "WinCC DDE-Server" Dialog Box:

Box/Button	Meaning
Settings	
Server ready	The DDE-server can be deactivated by means of this check box. If the server is deactivated, no new connections can be established to the DDE-server, additionally, no data transfer will take place on the existing connections.
Lock writing	Writing of the tags can be prevented by activating this check box.
Select tag	
"Tag list"	If WinCC runtime has been activated, the tag selection dialog of the WinCC Explorer can be called up via this button. All the configured tags are listed within the "Select tag" dialog. The DDE-address of the selected tag will be copied into the clipboard in a DDE-link format. This address can then, for example, be inserted directly into Excel as a link. <b>Note:</b> This button is only enabled, if WinCC runtime has been activated.

## 5.10.2 Integrating Tags via DDE

This chapter describes how a configured WinCC tag can be directly integrated into Excel.

There are two ways to establish a DDE-connection:

- Local DDE-Connection  
WinCC runs on a local computer as a single-user system, or on a server computer as a multi-user system.
- DDE-Connection via a network  
It is not necessary to start WinCC on the local computer to establish a DDE-connection.

Both methods require the program "DDEserv.exe" to be added to the WinCC computer startup list with the parameters "/v /nohold /noconfirm".

---

### Note:

The two parameters "/nohold /noconfirm" have the following meaning: When existing WinCC, the DDE-Server is deactivated without the user being prompted to confirm. The parameter "/v" opens the "WinCC DDE-Server" dialog box. Note the correct entry of these parameters. A blank character (space) must be inserted between the parameters.

---

## 5.10.3 Local DDE-Connection

To establish a local DDE-connection, one of the following requirements must be met:

- WinCC running on a local computer as a single-user system or as a multi-user system on a server computer;

Within WinCC, the following preparatory measures must be performed:

- Within the computer startup list, the DDE-server must be incorporated.

The DDE-server is located in the WinCC installation path (e.g. "C:\SIEMENS\WINCC\BIN\DDESERV.EXE").

The DDE-server must be started with the parameters "/v /nohold /noconfirm". The "/v" parameter opens the dialog box of the DDE-server. This dialog box allows you to select a project tag.

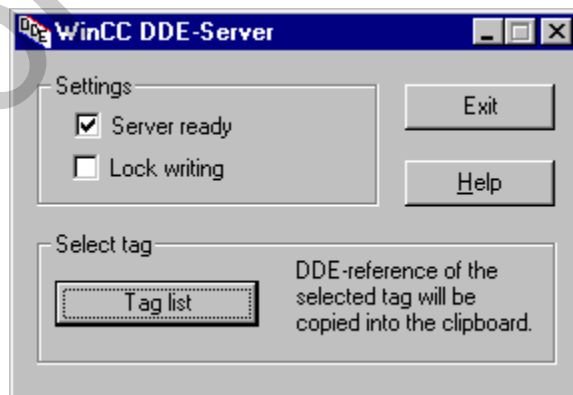

Within Excel, a WinCC tag can be integrated in the following way:

1. Change to the DDE-server. Display the tag list of the current WinCC project by clicking on the "Tag List" button. A tag can be selected from this dialog and be copied into the clipboard, as the DDE-reference, by clicking on the "OK" button.
2. Activate the Excel program.
3. Select the cell, in which you want to display the value of the WinCC tag.
4. Enter an equal sign "=" in the Excel formula bar.  
Copy the DDE-reference into the formula bar via the < Ctrl > + < V > key combination.  
Hit the return key to accept the value of the WinCC tag into the Excel cell.

	A	B
1	23	
2		
3		
4		

Formula bar: =WinCC|C:\SIEMENS\WINCC\WINCCPROJE\CTS\Test2\Test2.MCP!DDEVar1

This example displays an Excel table. The value of the WinCC tag "DDEVar1", which is contained in the "Test2.mcp" project, will be displayed in cell A1.



#### 5.10.4 DDE-Connection via a Network

To establish a DDE-connection via a network, it is not necessary to start WinCC on the local computer.

---

**Note:**

The following description uses the terms client and server. The server is the computer on which WinCC is running. The local computer is the client, which accesses a WinCC tag from the server computer via the network.

---

It is also important to know if WinCC is running as a single- or multi-user system on the server.

To access a WinCC tag, follow these steps:

1. The program "NetDDE.exe" must be started on both the client and the server.
2. **Windows NT :**

**Method 1:**

Include the program "NetDDE.exe" in the start-up folder. The "NetDDE.exe" program is located in the path, in which Windows NT has been installed (e.g. "C:\WINNT\SYSTEM32").

3. **Method 2:**

Under Windows NT, the NetDDE has been integrated as a system service and been set with the start type "Manual". The start type "Manual" has the following effect: The system service will only be started, if a corresponding request is made by a program (e.g. WinCC).

If the server uses Windows NT and WinCC has been installed as a multi-user system, it is not required to change the default start type (Manual) of the system service.

If a WinCC multi-user system is run on a Windows NT computer, the NetDDE system service will automatically be started once runtime is activated.

If a WinCC single-user system is run on a Windows NT computer, the NetDDE system service will NOT automatically be started once runtime is activated. To activate this system service, double-click on "Services" in the control panel. The "Services" dialog will be displayed. Select the "Network-DDE-Service" entry from the dialog and click on the "Start" button. Windows NT will then attempt to start the system service.

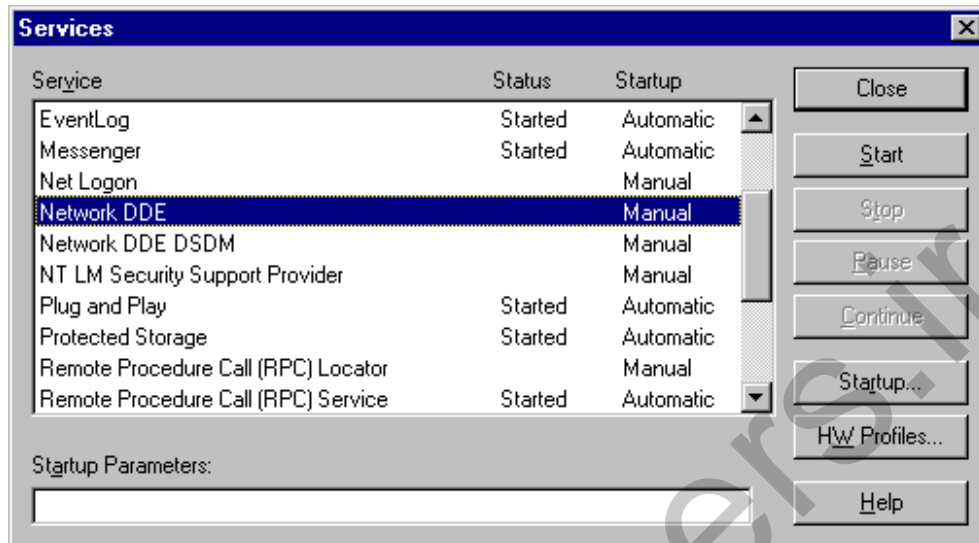

"Services" dialog box under Windows NT

- A DDE-share must be configured on the client and the server via the "DDEShare.exe" program.

#### Windows NT:

Under Windows NT, the "DDEShare.exe" program must be started and configured as follows:

On the task bar, click on "Start" and then on "Run".

In the "Run" dialog box, enter the text "DDEShare.exe" in the "Open" entry field and click on "OK".

Within the dialog box "DDE-Share on <Computer Name>", a DDE-share can be configured via the "Share" menu and the "DDE-Shares" entry. Activate the button "Add a Share".

The following values must be entered in the "DDE-Share Properties" dialog box: in the "Share Name" input field enter "PROJEKT" in the "Static" input field under "Application Name" enter "WINCC", and in the "Static" input field under "Topic Name" enter "project".

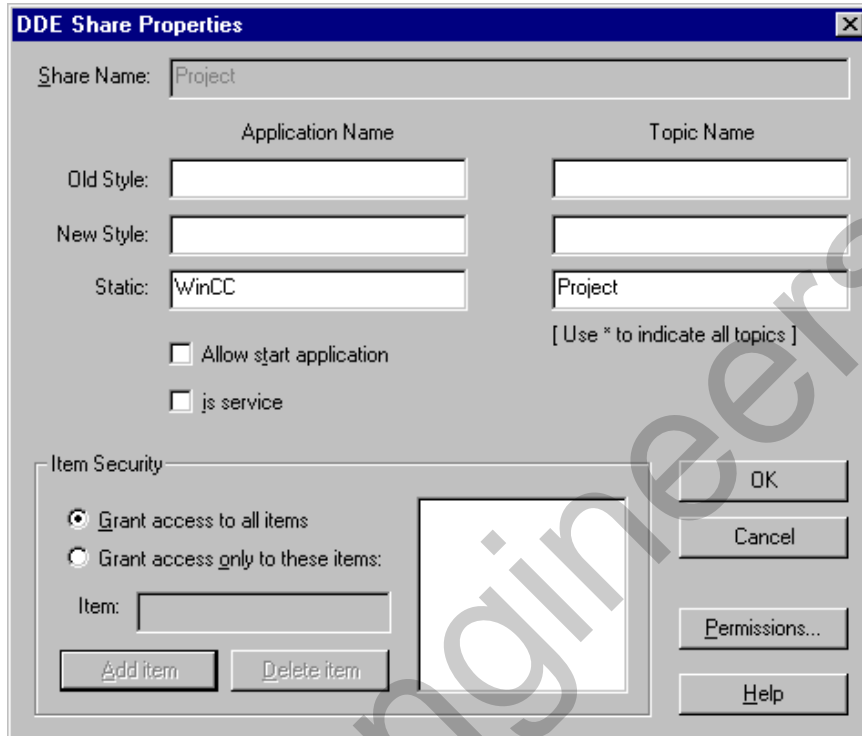

**DDE Share Properties**

Share Name: Project

Application Name	Topic Name
Old Style:	
New Style:	
Static: WinCC	Project

Allow start application  
 Is service

Item Security

Grant access to all items  
 Grant access only to these items:

Item: [Empty field]

Select the newly created DDE-share in the "DDE-Shares" dialog box and click on the "Trust-Share" button. Activate the "Initiate to Application Enable" check-box in the "Trusted-Share Properties" dialog box. Click on the buttons "Set" and "OK" to accept the settings.

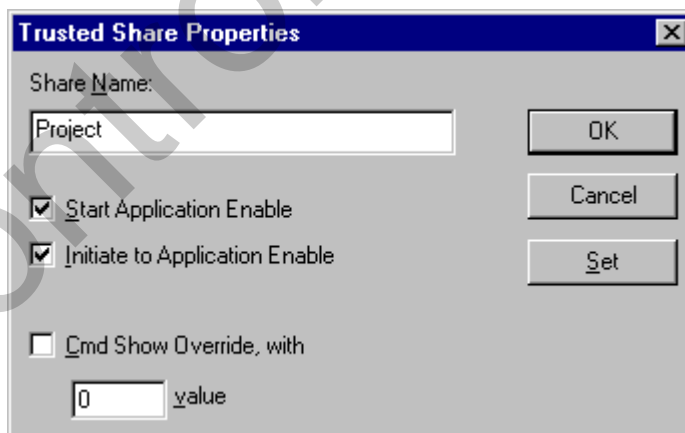

**Trusted Share Properties**

Share Name: Project

Start Application Enable  
 Initiate to Application Enable  
 Cmd Show Override, with  
 [0] value

#### 4. Activate the Excel program.

Select the cell, in which you want to display the value of the WinCC tag.

Enter an equal sign "=" in the Excel formula bar.

Enter the following text after the equal sign:

```
\\ComputerName\ndde$]PROJEKT!DDEVar1
```

The "ComputerName" entry must be replaced by a valid computer name (e.g. \\WINCC\_SERVER). Note that the \\ComputerName\ndde\$ entry must be enclosed by single quotation marks.

	A	B
1	11,00	
2		
3		

The value of the WinCC tag "DDEVar1", which is contained on the computer "\\DPC\_4002" project, will be displayed in cell A1.

### 5.10.5 Special DDE-Connection to Excel

This chapter describes how WinCC tags can be placed in several tables of an Excel workbook. The following description illustrates how a WinCC tag can be updated from Excel in runtime. It is also possible to update a WinCC tag in Excel from the WinCC runtime.

The following requirements must be met before a WinCC tag within an Excel book can be addressed.

1. A connection must be configured (e.g. "EXCEL\_1") within the communication driver "Windows DDE". For this connection, the following addressing, within the "DDE-Connection" tab, is required:
  - Computer name           the current computer name (optional)
  - Application               Excel
  - Topic                       [dde.xls]Table1

#### Note:

The "Excel" entry under Application is essential. This entry sets the name of the required application.

The entries under Topic have the following meaning:

The complete name of the desired Excel file must be entered within the square brackets. Immediately following the file name, the "Table1" entry, where the value 1 can be replaced by any other number, must be entered. The Table1 entry determines the memory location within an Excel book.

4. Within the connection (e.g. "EXCEL\_1") a new tag must be created (e.g. "dde\_bool1" of the data type "Binary Tag"). While creating the tag, activate the "Select" button in the "General Information" tab. The "Address Properties" dialog box will be displayed. Select the "DDE-Tag" tab and enter the position values (Excel manages all values via rows, which in turn are divided into rows and columns) for the Excel table in the "Tag Name" field (e.g. "z1s1", this means z1=row 1 and s1=column 1 within the table). Determine the required data type via the "Data Type" field.
5. Open Excel and create a blank workbook which must be saved under the name (e.g. "dde.xls") entered within the square brackets of the "Topic" field of the "Connection Properties" dialog of the "DDE-Connection".
5. To have Excel automatically open the required workbook (e.g. "dde.xls") while WinCC runtime is activated, make the following settings in the computer startup list:

Switch to the WinCC Explorer and select the required computer under the "Computer" project component. Activate the "Computer properties" dialog box via the pop-up menu entry "Properties".

Switch to the "Startup" tab and click on the "Add" button to display the "Add Application" dialog.

In the "Application" field, enter the complete program path and name of Microsoft Excel or the corresponding link (e.g. "C:\MSOffice\Excel\EXCEL.EXE"). In the "Parameter" field, the complete program path and name of the Excel workbook must be entered (e.g. "D:\Project\DDEFolder\dde.xls").

---

**Note:**

If you activate Excel and the workbook via the computer startup list, note the following: If the workbook (e.g. "dde.xls") is loaded, the data contained in the workbook will be transferred to the WinCC runtime system and be processed. Additionally, note that before activating runtime, the Excel workbook (e.g. "dde.xls") should not be open, otherwise the workbook would be opened write-protected.

---

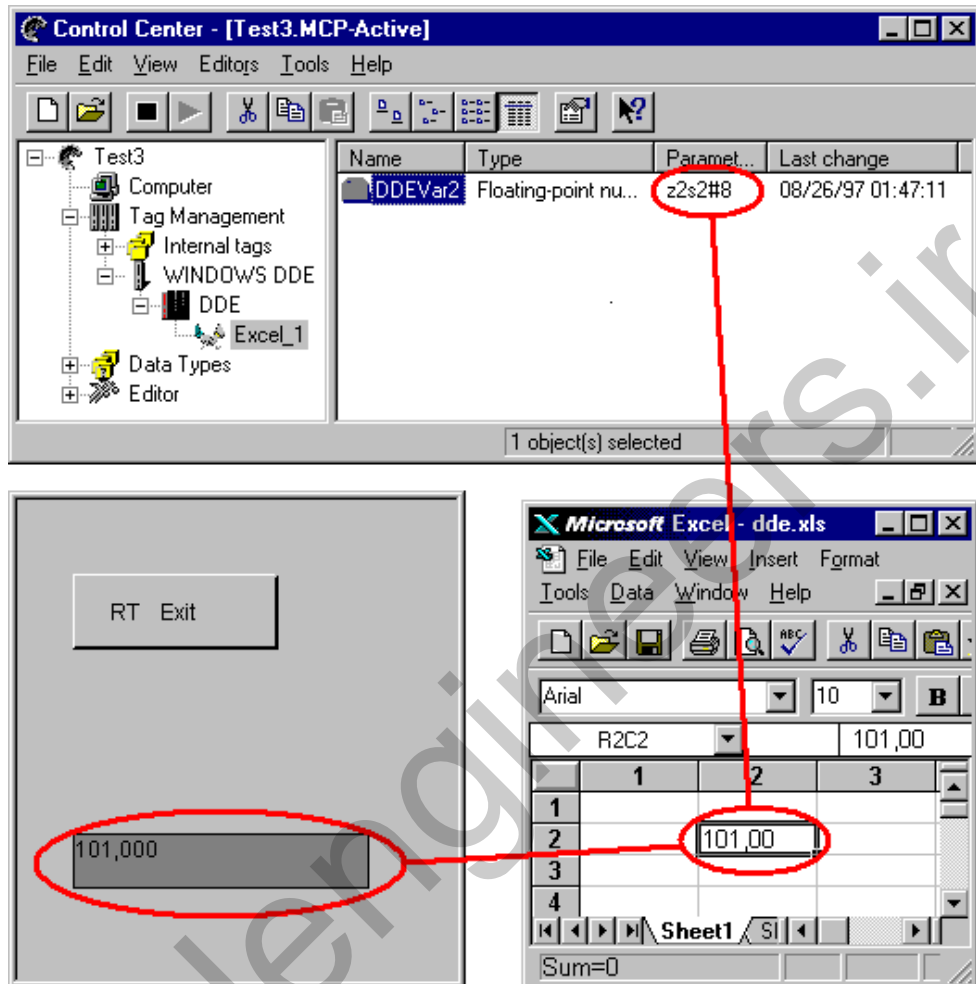

This example shows the interaction of Excel, the WinCC WinCC Explorer, and the WinCC Runtime System.



controlengineers.ir

## 6 Appendix

### 6.1 Adapting the Formats of Data Types

In WinCC, certain data types can be converted to other data types by adapting the scale. You can file an explanation of the individual target data types in the appropriate technical literature.

### 6.2 Page Layout Used

#### Page Layouts Used

The editors/components use different page layouts - that have been associated fixed with the print jobs - for printing or (page) viewing the project documentation. These different page layouts are described in the Online Help.

### 6.3 Terms/Abbreviations

API	Application Programming Interface
AS	Automation System
C	Higher programming language that was developed as a system development language (for example, for the UNIX operating system) and also as a universal programming language.
CEST	Central European Summer Time
CET	Central European Time
DCF77	Time signal transmitter in Frankfurt/Mainflingen, Germany. Provides the exact official time of the Federal Republic of Germany with a maximum deviation of 1 s in 1 million years.
DDE	Dynamic Data Exchange
DLL	Dynamic Link Library
DR	Drive letter of a storage medium (e.g.: "C" or "D" etc. for a hard disk)
GPS	Satellite system which determines precise position on the earth. Individual GPS satellites circle the earth at an approximate height of 20,000 km on different paths. Each satellite contains a very precise atomic clock (precision of a minimum of $1 \times 10^{-12}$ ). The data transmitted by the satellites are used to calculate the time.
LAN	Local Area Network
MFC	Microsoft Foundation Classes
ODBC	Open Database Connectivity
ODK	WinCC Open Developers Kit (optional description of the programming interface)
OLE	Object Linking and Embedding
OLX	OLE Custom Controls
OS	Operator Station
OVS	Object Management System
PDU	Protocol Data Unit
PLC	Programmable Logic Control
PMC	Process Monitoring Control
RS232	Serial interface
RT	Runtime



RTC	Real Time Clock (battery backed CMOS clock chip in the PC)
SBG	Signal module
SQL	Structured Query Language, data manipulation language for relational databases
ST	Summer time
SW	Software
Thread	A thread is a sub-function of a program that handles a very specific task.
TIS	Test and Startup
UTC	International time scale (Universal Time Coordinated)
WinNCC	WinCC (formerly operator control and process monitoring)
Wizard	Auxiliary program for handling complex tasks (Assistant)
WT	Winter time

controlengineers.ir

## Index

### A

- Activate 2-5
  - Setting components 3-5
- Activation
  - Automatic activation 2-5
  - Inhibit activation 2-5
  - Set Start Picture 3-11
  - Setting Runtime Language 3-11
- Addressing 4-26
- Addressing the Server 5-10
- Alarm Logging 5-1
- Alpha Cursor 3-11
- Automatic Activation 2-5

### C

- Changing Data Format 4-12
- Channel Unit 4-38, 4-42
  - Automatic startup 4-43
  - Bit access 4-43
  - Byte access 4-43
  - Lifebeat monitoring 4-43
  - Logical connection 4-42
  - Online connections 4-43
  - Online tags 4-43
  - Remote tags 4-43
  - System parameter 4-39
- Client-Server
  - Add computer 3-3
  - Computer type 3-3
  - Delete computer 3-2, 3-3
  - Licensing 1-2
  - Set computer 3-2
  - Status of client 2-10
  - Status of multi-user operation 2-10
  - Status of server 2-10
- Communication Driver 3-19, 4-36
  - Channel unit 4-38
  - Delete 4-37
  - Install 4-37
  - Logical connection 4-45
- Computer 3-2
  - Add 3-2
  - Delete 3-2
- Computer Name 3-3
  - Physical 5-10
  - Redundant 5-10
  - Symbolic 5-10
- Connection 4-1, 4-12, 4-45, 4-46

- Create 4-30, 4-42, 4-45
- Delete 4-42
- Editing 4-42
- Status 2-9
- Tag group 4-46
- Conversion
  - of library 5-8
  - of pictures 5-8
- Copy
  - a tag 4-2
  - a tag group 4-31
- Create
  - a tag 4-48
  - a tag group 4-47
- Cross Reference 5-1
- Cursor Control 3-11
- Cut
  - a tag 4-2
  - a tag group 4-31

### D

- Data Source
  - ES 4-26
  - STEP 7 Symbol 4-26
  - WinCC tags 4-26
- Data Type 4-19
  - Convert 4-12
  - Structure type 4-21
  - Text reference 4-20
- Data Window 2-14
- DDE 5-21
  - DDE connection 5-22, 5-24, 5-27
  - DDE Share 5-24
  - Net DDE 5-24
  - System service 5-24
- Deactivate 2-5
- Default Server 5-11, 5-14, 5-16
- Delete
  - a tag 4-2, 4-48
  - a tag group 4-31, 4-47

### E

- Editing Language 2-8
- Editor
  - Basic WinCC system editors 3-21
  - Optional editors 3-21
- Error while updating 5-13
- Exit 2-6
- Exit WinCC 2-6, 2-7

Exit Windows 2-7

## F

Find

Search by object 2-15, 2-16

Search by tag 2-15, 2-16

Find Function 2-15, 2-16

## G

Graphics Designer 5-4

## H

Hardcopy

Print 3-5

Hotkeys 3-11, 3-27

Double-assignment 3-27

## I

Inhibit Activation 2-5

Internal Tag

Create 4-5

Editing 4-5

Recording limit values 4-7

## L

Language

Editing Language 2-8

Runtime language 5-2

Limit Values

of tags 4-7, 4-17, 4-18

Link Graphic Objects 5-6

Logging

of tags 4-7, 4-17, 4-18

Logical Connection 4-1, 4-12, 4-45, 4-46

Create 4-30, 4-42, 4-45

Delete 4-42

Editing 4-42

Status 2-9

Tag group 4-46

## M

Menu.doc Commands 2-1

Multi-Client

Select process tags 5-18

Set message server 5-17

Multi-Client Project 2-3

Multi-User Project 2-3, 5-9

Add computer 3-3

Computer type 3-3

Delete computer 3-3

Delete computer 3-2

Set computer 3-2

## N

Naming Conventions 4-1

Navigation Window 2-13

## P

Package

Addressing the server 5-10

Create 5-9

Delete 5-9

Find 5-9

Load 5-12

New 5-15

Set default server 5-14, 5-16

Set redundant server 5-16

Update 5-13

Page Layouts Used 6-1

Physical Computer Name 5-10

Picture

Convert pictures 5-8

Create 5-4

Open 5-4

Picture Store 3-11

PowerTags 2-12

Print

a hardcopy 3-5

Print Screen 3-27

Process Tag

Address 4-26

Addressing 4-17, 4-18

Adjust format 4-12

Convert data type 4-12

Create 4-9, 4-10, 4-48

Delete 4-48

Editing 4-9, 4-10, 4-48

Limit values 4-17, 4-18

Linear scaling 4-12

Logging 4-17, 4-18

Properties 4-12

Set address 4-12

Project

Activate 2-5

Create 2-3

- Deactivate 2-5
- Setting project type 2-3, 3-24
- Structure of a project 3-1
- Project Component 3-1
  - Computer 3-2
- Project Navigation Window 2-13
- Project Properties 3-23, 3-24, 3-26

## R

- Raw Data Tag 4-25
- RDT\_ARCHIV 4-25
- RDT\_BSEND 4-25
- RDT\_EVENT 4-25
- RDT\_S7PDU 4-25
- Redundant Computer Name 5-10
- Report Designer 5-2
- Runtime
  - Activate 2-5
  - Alpha cursor 3-11
  - Cursor control 3-11
  - Hotkeys 3-11
  - Inhibit activation 2-5
  - Lock key combination 3-9
  - Navigation in picture store 3-11
  - Picture Store 3-11
  - Picture Window 3-11
  - Print a hardcopy 3-5
  - Set language 3-9, 5-2
  - Set Start Picture 3-11
  - Setting components 3-5
  - Setting Start Picture 2-5
  - Startup 3-5
  - Status of connections 2-9
  - Status of multi-user operation 2-10
  - Tab Order 3-11
- Runtime Language 3-9

## S

- Server Addressing 5-10
- Set Runtime Language 5-2
- Set Server 5-17, 5-18
- Set Start Picture 3-11
- Shutdown 2-7
- Single User Project 2-3
- Startup Behavior 3-5
- Status
  - Connections 2-9
  - Multi-user operation 2-10
- Status Bar 2-12
- Structure Tag
  - Editing structure type 4-21

- Structure Type 2-13, 4-21
- Struktur Tag
  - Create structure type 4-21
- Symbolic Computer Name 5-10
- System Parameter 4-39

## T

- Tab Order 3-11
- Tag 4-5, 4-11
  - Copy 4-1
  - Create 4-5, 4-48
  - Cut 4-1
  - Data type 4-19
  - Delete 4-1, 4-48
  - Editing 4-1, 4-5, 4-48
  - Internal tag 4-1, 4-5, 4-7
  - PowerTags 2-12
  - Process Tag 4-12
  - Process tags 4-1, 4-9, 4-10, 4-17, 4-18
  - Raw data tag 4-1, 4-25
  - Selection dialog 4-26
  - Structure tag 4-21
  - Tag address 4-26
  - Text reference tag 4-20
  - Updating 4-1
- Tag Group 4-30, 4-47
  - Conventions for names 4-1
  - Copy 4-31
  - Create 4-30, 4-47
  - Cut 4-31
  - Delete 4-31, 4-47
  - Editing 4-31, 4-47
- Tag Logging 5-3
- Tag Management 2-13, 3-19
- Tag Names 4-1
- Tag Selection 4-26
- Terms / Abbreviations 6-1
- Text Library 5-2
- Text Reference 4-20
- Text Reference Tag
  - Assign Text-ID 4-20
  - Create 4-20
- Toolbar 2-12

## U

- Update Cycles 3-26
- User Administrator 5-1
- User Cycles 3-26

## W

WinCC Explorer 1-1

controlengineers.ir

## SIMATIC HMI

## WinCC

Manual  
Volume 1 / 2

### Volume 1

Preface	1
System Overview	2
Authorization	3
WinCC Explorer	4
Channels	5
Report Designer	6
User Administrator	7

### Volume 2

Graphics Designer	8
Alarm Logging	9
Tag Logging	10
Text Library	11
Global Script	12
Cross Reference	13

This manual is part of the documentation package with the order number: 6AV6392-1XA05-0AB0

Edition August 1999

WinCC®, SIMATIC®, SIMATIC NET®, SINEC® and STEP® are Siemens registered trademarks.

All other product and system names in this manual are (registered) trademarks of their respective owners and must be treated accordingly.

(The reproduction, transmission or use of this document or its contents is not permitted without express written authority. Offenders will be liable for damages. All rights, including rights created by patent grant or registration of a utility model or design, are reserved.)

(We have checked the contents of this manual for agreement with the hardware and software described. Since deviations cannot be precluded entirely, we cannot guarantee full agreement. However, the data in this manual are reviewed regularly and any necessary corrections included in subsequent editions. Suggestions for improvement are welcomed.)

© Siemens AG 1994 - 1999 All rights reserved

Technical data subject to change

C79000-G8276-C159

Printed in the Federal Republic of Germany

Siemens Aktiengesellschaft

# Table of Contents

<b>1</b>	<b>Overview</b> .....	<b>1-1</b>
<b>2</b>	<b>Requirements</b> .....	<b>2-1</b>
<b>3</b>	<b>Procedure</b> .....	<b>3-1</b>
<b>4</b>	<b>Configuring the Communication Driver</b> .....	<b>4-1</b>
4.1	SIMATIC S5 Serial 3964R Communication Driver.....	4-3
4.1.1	Data Type of Tags.....	4-3
4.1.2	Address of Tags .....	4-4
4.1.3	Connection Parameters.....	4-7
4.2	SIMATIC S5 Programmers Port AS511 Communication Driver .....	4-9
4.2.1	Data Type of Tags.....	4-9
4.2.2	Address of Tags .....	4-10
4.2.3	Connection Parameters.....	4-14
4.3	SIMATIC S5 Ethernet Layer 4 Communication Driver .....	4-15
4.3.1	System Parameters.....	4-16
4.3.2	Data Type of the Tags.....	4-18
4.3.3	Tag Address .....	4-18
4.3.3.1	Entering the address of a tag .....	4-19
4.3.4	Connection Parameters.....	4-23
4.4	SIMATIC S5 Ethernet TF Communication Driver.....	4-25
4.4.1	System Parameters.....	4-26
4.4.2	Data Type of the Tags.....	4-27
4.4.3	Tag Address .....	4-28
4.4.4	Connection Parameters.....	4-30
4.5	SIMATIC S7 Protocol Suite Communication Driver .....	4-32
4.5.1	System Parameters.....	4-33
4.5.1.1	Channel Tab.....	4-33
4.5.1.2	Unit Tab .....	4-34
4.5.2	Data Type of the Tags.....	4-36
4.5.3	Address of the Tag .....	4-37
4.5.4	The Raw Data Tags of the S7 Communications Driver .....	4-39
4.5.4.1	Raw Data Tags for User-Defined Applications:.....	4-39
4.5.4.2	Raw Data Tag as Byte Array.....	4-40
4.5.4.3	Raw Data Tag for S7 Communication with BSEND/BRCV Functions .....	4-41
4.5.4.4	Raw Data Tags for BSEND/BRCV Functions .....	4-43
4.5.5	Data Exchange with S7 Function Blocks (AR_SEND).....	4-44
4.5.5.1	Configuration of "AR_ID" and "AR_SEND" Subnumber .....	4-47
4.5.5.2	Data Exchange with "AR_SEND" for an Archive Tag .....	4-48
4.5.5.3	Data Exchange with "AR_SEND" for multiple Archive Tags.....	4-48
4.5.5.4	Data Exchange with "AR_SEND" for multiple Archive Tags - Optimized ...	4-50
4.5.6	Connection Parameters.....	4-51
4.5.6.1	S7 MPI Channel Unit.....	4-51
4.5.6.2	SINEC PROFIBUS Channel Unit .....	4-53
4.5.6.3	SINEC Industrial Ethernet Channel Unit .....	4-55
4.5.6.4	Named Connections Channel Unit.....	4-57



4.5.6.5	SINEC Slot PLC Channel Unit .....	4-59
4.5.6.6	SINEC-TCP/IP Channel Unit.....	4-60
4.5.7	Software Redundancy .....	4-62
4.5.7.1	Connection-specific Internal Tags .....	4-68
4.6	SIMATIC TI505 Serial Communication Driver.....	4-72
4.6.1	Data Type of Tags .....	4-72
4.6.2	Address of Tags .....	4-73
4.6.3	Connection Parameters.....	4-74
4.7	SIMATIC TI505 Ethernet Layer 4 Communication Driver .....	4-75
4.7.1	Data Type of Tags .....	4-75
4.7.2	Address of Tags .....	4-76
4.7.3	System Parameters .....	4-79
4.7.4	Connection Parameters.....	4-81
4.8	Windows DDE Communication Driver.....	4-83
4.8.1	Data Type of Tags .....	4-83
4.8.2	Address of Tags .....	4-84
4.8.3	Connection Parameters.....	4-85
4.9	WinCC "Channel Diagnosis" .....	4-87
4.9.1	Structure .....	4-88
4.9.1.1	"Channels/Connections" Tab.....	4-88
4.9.1.2	"Configuration" Tab .....	4-91

# 1 Overview

In this document, you will become acquainted with:

- The requirements that are necessary for accessing process tags by means of a programmable logic controller.
- The general procedure for connecting external tags.
- The specific configuration of a communication driver.

---

## Note

In the WinCC Explorer Manual and in the on-line help for the WinCC Explorer, you will find detailed information on the operations necessary for implementing the process driver connection. This document provides you with supplementary information on the special features of the communication drivers used (tag addressing in the PLC and assignment of communication parameters for the logical connection).

---

To implement the process driver connection, you need to have knowledge of the PLC and the communication being used. If you did not configure the PLC yourself, familiarize yourself with the technical documentation on this topic.

In addition, the hardware required for communication as well as the drivers needed by the operating system must be completely installed already in the WinCC system. You should also consult the technical documentation to familiarize yourself with these items.

controlengineers.ir

## 2 Requirements

From WinCC, you can access process tags (external tags) in a PLC.  
However, before you configure the process driver connection in WinCC, you should use a check list to see if the following requirements have been met:

The PLC must be equipped with a communication interface that WinCC supports by means of a communication driver.

This interface in the PLC must be properly configured such that the control program can access the interface by means of the communication calls. The configuration parameters for the communication hardware must be known.

The addresses of the tags (depending on the PLC used) that WinCC is supposed to access must be known.

The appropriate communication hardware (communication port COM1, ... or module) must be installed in the WinCC system. If a module is installed, the accompanying operating system driver must have been installed. The hardware or software settings for the communication module must be known.

Depending on the communication module you use in the WinCC system, you may have to make additional configurations for communication (such as creating a local database for Industrial Ethernet or PROFIBUS). These communication parameters must also be known.

The following requirements must also be fulfilled in the RUNTIME mode to access tags:

The PLC must be connected to the process.

The physical connection between the PLC and the WinCC system must be installed and be functional.

controlengineers.ir

### 3 Procedure

Process communication between the WinCC system and the PLC is structured as follows:

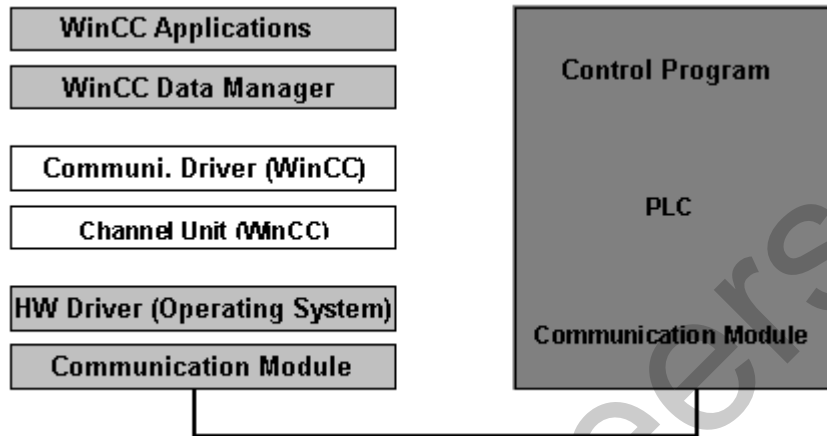

If you want to connect external tags, you must proceed as follows:

Select the communication driver that supports the desired driver connections. Depending on the PLC that is connected, the communication driver contains one or more channel units.

Select the desired channel unit.

Configure a logical connection for the channel unit.

Define the tags or the tag groups with their tags and the system-specific addresses of the tags in each particular PLC.

The address configuration for the communication driver used is explained in the section called "Configuring the Communication Driver".

Configure the communication-specific properties of the connection.

This configuration is described in more detail for each particular channel unit in the section called "Configuring the Communication Driver".

Check the status of driver connections in the RUNTIME mode.

You install the communication driver, configure a logical connection for a channel unit, and define the tag or tag group with the help of the WinCC Explorer. These procedures are described in detail in the WinCC Explorer Manual.

## Communication Driver

To access external tags, you have to install the communication driver for the communication with the remote PLC.

Depending on the driver, the communication driver contains one or more channel units. By means of the operating system interface and the hardware driver, a channel unit supports the hardware component (communication port or PC module) necessary for communication.

### Channel Unit (Driver Connection)

The channel unit is a part of the communication driver. It is necessary for communication with the operating system interface of the communication hardware.

The logical connections are operated by means of the channel unit. The logical connections provide access to the tags.

---

#### Note

It is possible that a communication driver also has system parameters (such as device names or protocol parameters) for a channel unit. These parameters are handled separately for the channel units of the corresponding communication drivers.

---

## Logical Connection

The logical connection handles the communication with the PLC that enables access to the external tags in the process. The name of the connection is unique.

For the logical connection, you must define the tags of the remote PLC subsequently. You can configure individual tags as well as groups of tags. The address information necessary for configuration always refers to the PLC that you want to access by means of the logical connection.

Finally, you must specify communication parameters for this connection (such as the bus address of the PLC). These parameters depend on the channel unit (driver connections) of the communication driver being used.

The channel unit handles access to the communication interface of the operating system.

You can call up and change the properties of the connection (configured groups, configured tags, and communication parameters).

The WinCC Explorer (menu "Options" - "Status of Driver Connections") enables you to check the status of driver connections in the RUNTIME mode.

## Group (Tag Group)

A group (tag group) groups tags to make them easier to manage.

In this group, you can configure tags that you can then access by means of the logical connection.

You can call up and change the properties of the group (configured tags).

## Tag, Group Tag

The analysis and control of the process is handled by tags that are stored at a defined address and in a specific length in the PLC. You configure these process values in WinCC as tags or group tags with a name, the data type, and the address in the PLC. For the standard data types, the length is derived implicitly from the type; for string tags, you must specify the length.

The assignment to the PLC is made by means of the logical connection. For the logical connection, you specify the parameters that are necessary for the communication in a tab for specific communication.

You can call up and change the properties of tags (data type, address, and, where necessary, length).

---

### Note

If the connection is not displayed, you can make the connections visible by double clicking on the channel unit (or on the communication driver and the channel unit). If the desired group is not displayed, you can make it visible by double clicking on the connection.

---



The address information for the process tag refers to the particular PLC in which the tag is located. Because this information also depends on the communication driver being used, for on-line help you first select the communication driver being used:

- SIMATIC S5 Serial 3964R
- SIMATIC S5 Programmers Port AS511
- SIMATIC S5 Ethernet Layer 4
- SIMATIC S5 Ethernet TF
- SIMATIC S7 Protocol Suite
- SIMATIC 505 Serial
- SIMATIC 505 Ethernet Layer 4
- Windows DDE
- PROFIBUS FMS
- Allen Bradley Serial DF1
- ModBus Serial
- Applicom Multi Protocol Interface
- SIPART DR

## 4 Configuring the Communication Driver

WinCC provides the following communication drivers for the process driver connection:

- SIMATIC S5 Serial 3964R for serial communication with SIMATIC S5 by means of the channel unit (driver connection):
  - S5-RK512 (3964R)
- SIMATIC S5 Programmers Port AS511 for serial communication with SIMATIC S5 by means of the channel unit (driver connection):
  - S5-AS511
- SIMATIC S5 Ethernet Layer 4 for communication with SIMATIC S5 (Industrial Ethernet) by means of the channel unit (driver connections):
  - S5-Transport (CP1413-1) (transport protocol of layer 4)
  - S5-Transport (CP1413-2) (transport protocol of layer 4)
- SIMATIC S5 Ethernet TF for communication with SIMATIC S5 (Industrial Ethernet) by means of the channel unit (driver connections):
  - S5 Application (CP1413-1) (TF protocol of layer 7)
- SIMATIC S7 Protocol Suite for communication with SIMATIC S7 by means of the channel units (driver connections):
  - Industrial Ethernet and Industrial Ethernet(II)
  - S7-MPI
  - Named Connections
  - PROFIBUS and PROFIBUS (II)
  - Slot PLC
  - TCP/IP
- SIMATIC 505 Serial for serial communication with SIMATIC 505 by means of the channel unit (driver connection):
  - 505 Unit #1
- SIMATIC 505 Ethernet Layer 4 for communication with SIMATIC 505 (Industrial Ethernet) by means of the channel units (driver connections):
  - TI-Ethernet (CP 1413-1) (transport protocol of layer 4)
  - TI-Ethernet (CP 1413-2) (transport protocol of layer 4)
- Windows DDE for communication by means of a Windows DDE interface:
  - DDE

In addition to these communication drivers included with WinCC, the following communication drivers are available as options:

- PROFIBUS FMS for communication with PLCs by means of the channel unit (driver connection):

PROFIBUS-FMS

- Allen Bradley Serial DF1 for communication with Allen Bradley by means of the channel unit (driver connection):

AB 1

- ModBus Serial for communication by means of the ModBus with the channel units (driver connections):

Modbus Unit #1

Modbus Unit #2

Modbus Unit #3

Modbus Unit #4

Modbus Unit #5

Modbus Unit #6

Modbus Unit #7

Modbus Unit #8

- Applicom Multi Protocol Interface for external connections (such as Télémécanique, ModBus, ...) by means of the channel unit (driver connection):

Applicom 1

- SIPART DR for communication with the controllers DR19, DR20, DR21, DR22 and DR24 by means of the channel unit (driver connection):

SIPART

## 4.1 SIMATIC S5 Serial 3964R Communication Driver

This communication driver is used for the serial connection to a SIMATIC S5 PLC.

### Channel Unit

This communication driver has a channel unit that makes it possible to operate a COM port for serial connection.

The following application is available:

- Channel Unit S5-RK512 (3964R) for serial communication by means of the 3964R or 3964 protocol.

### 4.1.1 Data Type of Tags

You define the tags necessary for a logical connection. WinCC enables you to access the following data types:

- Binary tag
- Unsigned 8-bit value
- Signed 8-bit value
- Unsigned 16-bit value
- Signed 16-bit value
- Unsigned 32-bit value
- Signed 32-bit value
- 32-bit IEEE 754 floating-point number
- Text tag 8-bit character set
- Raw data type

### 4.1.2 Address of Tags

You enter the tag address according to the address structure of SIMATIC S5.

How to Enter the Tag Address:

1. Select the tag and use the pop-up menu to open the "Properties" dialog box.
2. In the "General Information" tab, select the desired data type (for example, signed 8-bit value).
3. Click on the "Select" button. The "Address Properties" dialog window opens.
4. Select the "Address" tab.

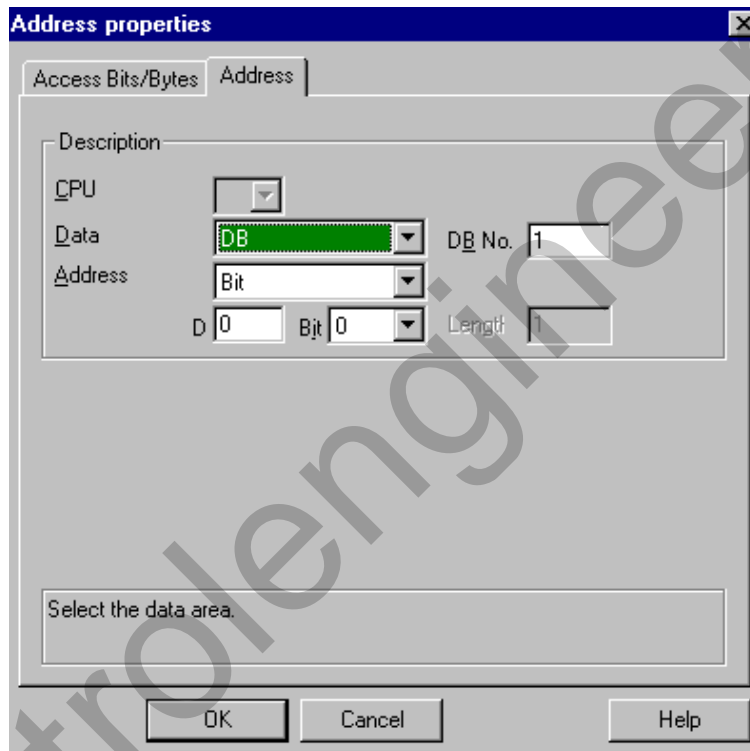

5. In the "Data Area" box, select whether the tag is located in a data block, in an extended data block, in a bit memory (flag) area, or in an input or output area.
6. If the tag is in a data block, the "DB No." box is also displayed. Enter the number of the data block here.
7. The "Addressing" box indicates the type of addressing. Usually you can accept the default.
8. Enter the address in the appropriate box (for example, "DL").

---

#### Note

Do not use any data word addresses that are greater than 255. Because of a system property of the RK 512, only data word addresses from 0 to 255 are permitted.

You can configure larger addresses; however, this results in data corruption on all configured tags of this connection.

---

Access to the memory locations of a PLC can often take place only by byte or word. If binary or 8-Bit tags are used, the “Address Properties” dialog will contain an additional tab, through which individual bits, in the PLC’s memory locations, can be changed. For that reason, every write instruction reads the addressed memory location from the PLC and changes the corresponding bits/bytes. Afterwards, the data is written back into the PLC.

#### Note

Changes to the read data, made by the PLC, will be overwritten during the write back.

Depending on the tag type, access, to the memory locations of a PLC, is carried out either by bit or by byte

#### Setting the by Bit Access:

1. Right mouse button click on the desired tag to open its pop-up menu, and select “Properties”.
2. Open the “General Information” tab and select the “Binary Tag” data type.
3. Click on the “Select” button to open the “Address Properties” dialog.

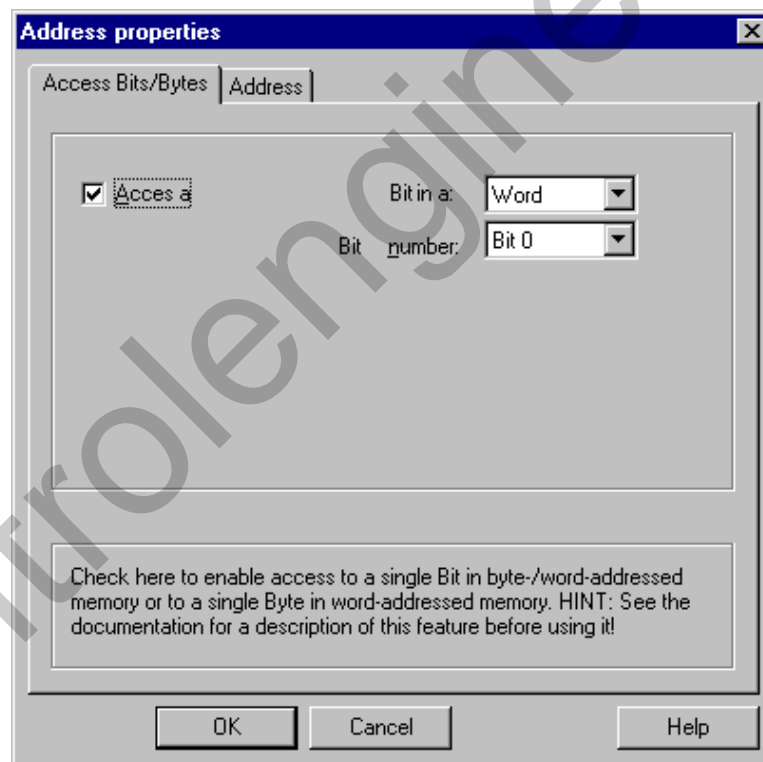

4. Via the checkbox, the “By Bit” accessing method can be selected.
5. Select the addressing method of the PLC memory locations from the list box.
6. Select the number of the bit to be changed list box.

#### Note

In the S5 PLC, markers, inputs, and outputs can be addressed by byte, and data blocks (DB, DX) can be addressed by word.

### Setting the by Byte Access

1. Right mouse button click on the desired tag to open its pop-up menu, and select “Properties”.
2. Open the “General Information” tab and select the “Unsigned 8-Bit Value” or “Signed 8-Bit Value” data type.
3. Click on the “Select” button to open the “Address Properties” dialog.

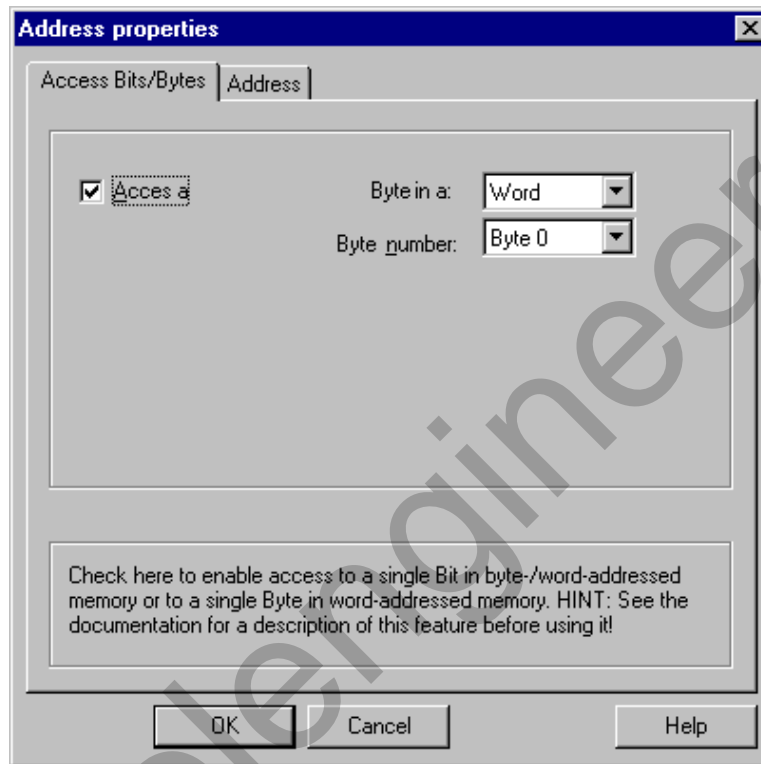

4. Via the checkbox, the “By Byte” accessing method can be selected.
5. Select the addressing method of the PLC memory locations from the list box.
6. Select the number of the bit to be changed from the list box.

### 4.1.3 Connection Parameters

The process driver connection by means of serial connection is possible with the SIMATIC S5 PLC. In the PLC, the CP 544 or a second plug-in serial interface is used on the CPU module (card slot SI2).

No additional communication module is needed in the WinCC system. Communication takes place by means of one of the standard COM ports in the system.

#### How to Configure the Communication Parameters:

1. Select the connection and use the pop-up menu to open the "Properties" dialog box.
2. Select the "Serial 3964R" tab.

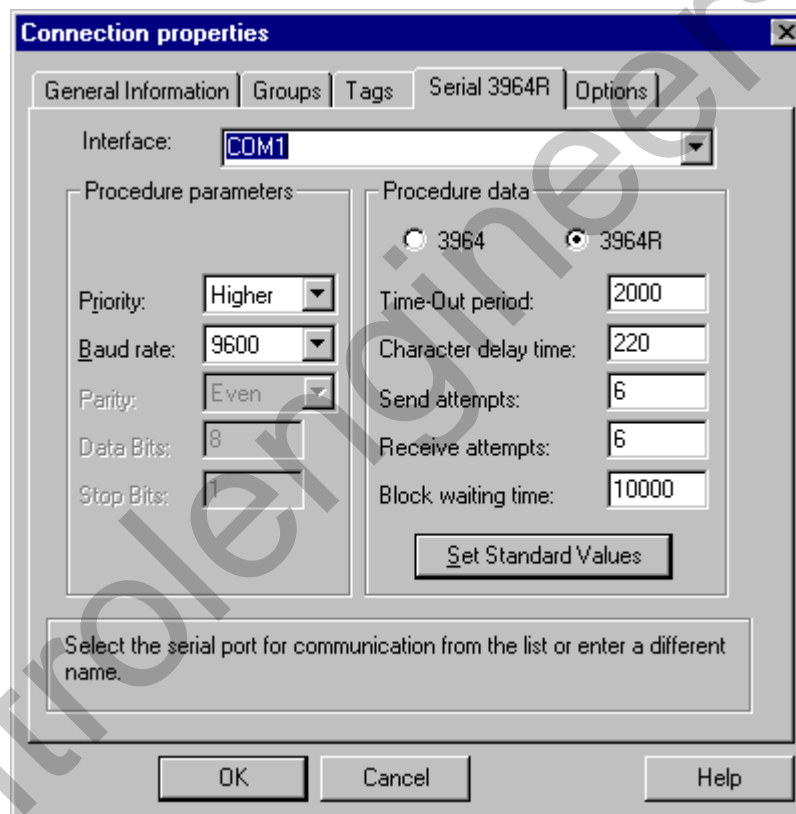

3. In the "Interface" box, select the communication interface (COM1 or COM2) for serial connection.

In the "Procedure-Parameters" area, in the "Baud Rate" box, set the data transmission speed to the value used. You set the priority in the event of an initiation conflict (simultaneous send request from WinCC and the PLC) in the "Priority" box.

---

#### Note

It is mandatory to set the priority to something different than is set for the SIMATIC S5.

---



5. In the "Procedure Data" area, select either the "3964" or "3964R" transmission protocol. Default values for the procedure data (such as time-out and character delay time) should only be changed in exceptional cases. If you change them, make sure that they match the parameters in the PLC.
6. Now select the "Options" tab.

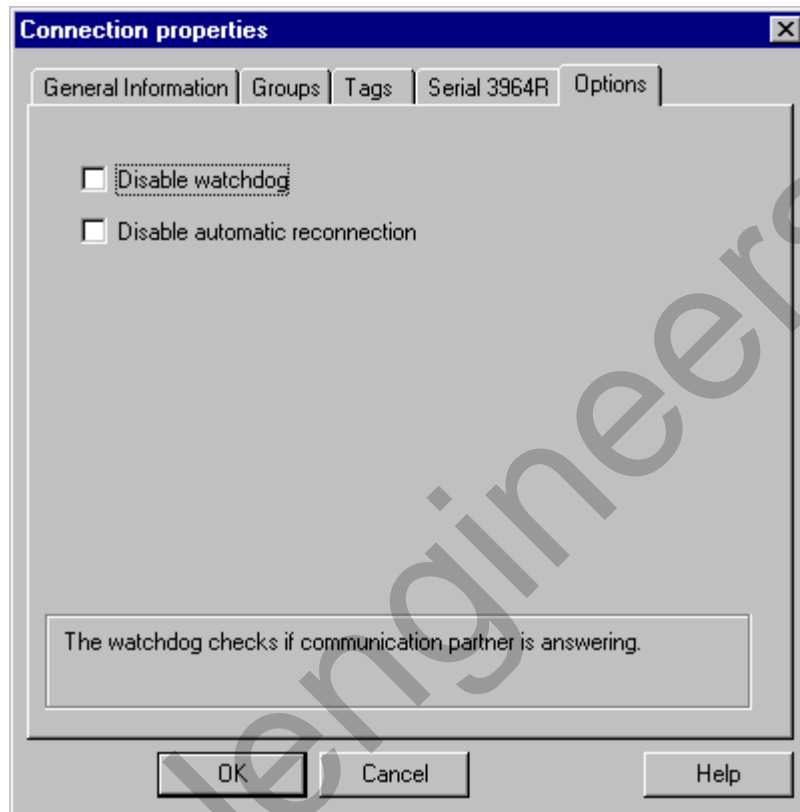

7. In the "Options" tab you can turn off the cyclic life-beat monitoring and suppress the automatic connection setup.

## 4.2 SIMATIC S5 Programmers Port AS511 Communication Driver

This communication driver is used for serial connections to a SIMATIC S5 PLC by means of a TTY interface.

### Channel Unit

This communication driver contains a channel unit that makes it possible to operate a COM port for serial connection.

The following application is available:

- Channel Unit S5-AS511 for serial communication by means of a "Siemens-specific" protocol.

### 4.2.1 Data Type of Tags

You define the tags necessary for a logical connection. WinCC enables you to access the following data types:

- Binary tag
- Unsigned 8-bit value
- Signed 8-bit value
- Unsigned 16-bit value
- Signed 16-bit value
- Unsigned 32-bit value
- Signed 32-bit value
- 32-bit IEEE 754 floating-point number
- Text tag 8-bit character set
- Raw data type

## 4.2.2 Address of Tags

You enter the tag address according to the address structure of SIMATIC S5.

How to Enter the Tag Address:

1. Select the tag and use the pop-up menu to open the "Properties" dialog box.
2. In the "General Information" tab, select the desired data type (for example, signed 8-bit value).
3. Click on the "Select" button. The "Address Properties" dialog window opens.
4. Select the "SYSVAR" tab.

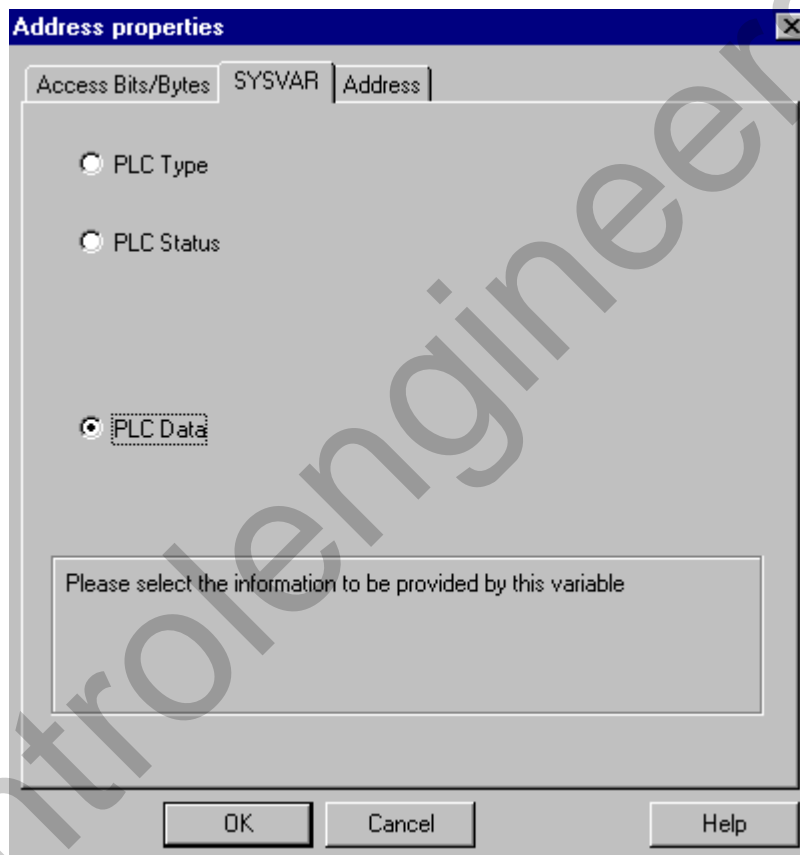

5. Click on an option button to indicate whether the tag should transmit the type of controller ("PLC Type"), the current status ("PLC Status"), or other data ("PLC Data").

6. If you select "PLC Data," you must also click on the "Address" tab to specify the S5 address of the tag.

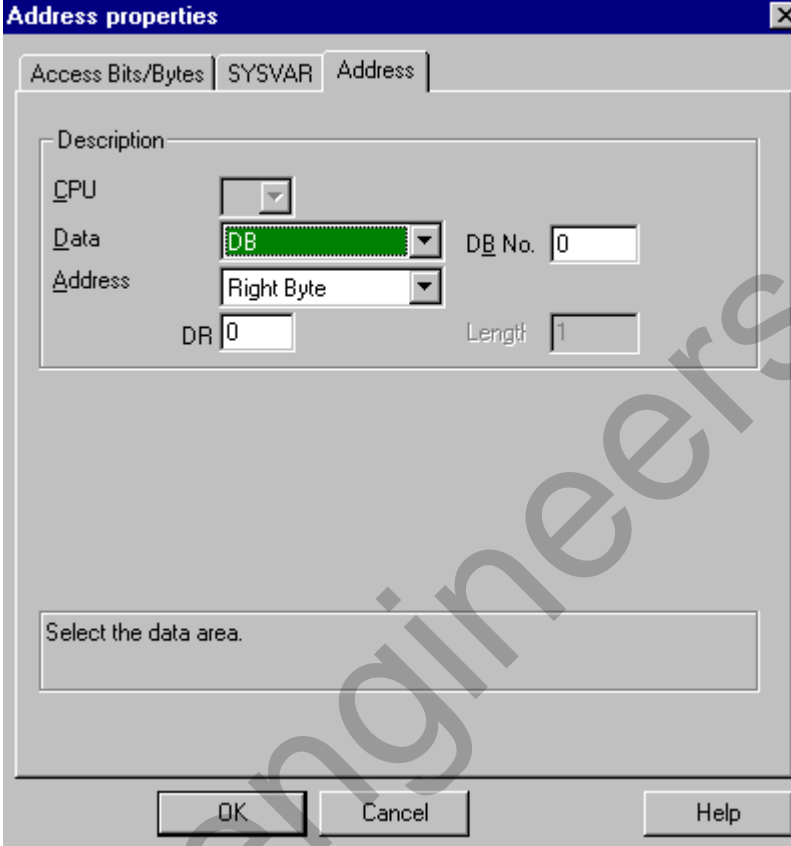

7. Select the "Data Area," that is, whether the tag is in a data block, in an extended data block, in a bit memory (flag) area, or in the input or output area.
8. If the tag is in a data block, the "DB No." box is also displayed. Enter the number of the data block here.
9. The "Addressing" box indicates the type of addressing. Usually you can accept the default.
10. Enter the address in the appropriate box (for example, "DW").

Access to the memory locations of a PLC can often take place only by byte or word. If binary or 8-Bit tags are used, the "Address Properties" dialog will contain an additional tab, through which individual bits, in the PLC's memory locations, can be changed. For that reason, every write instruction reads the addressed memory location from the PLC and changes the corresponding bits/bytes. Afterwards, the data is written back into the PLC.

---

#### Note

Changes to the read data, made by the PLC, will be overwritten during the write back.

Depending on the tag type, access, to the memory locations of a PLC, is carried out either by bit or by byte

---

### Setting the by Bit Access:

1. Right mouse button click on the desired tag to open its pop-up menu, and select “Properties”.
2. Open the “General Information” tab and select the “Binary Tag” data type.
3. Click on the “Select” button to open the “Address Properties” dialog.

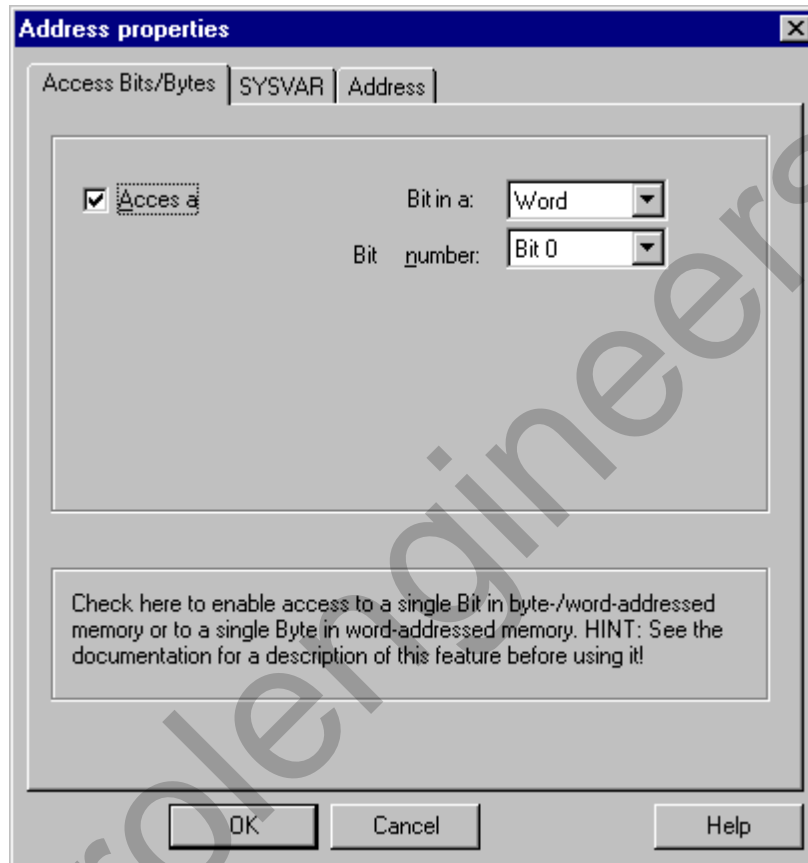

4. Via the checkbox, the “By Bit” accessing method can be selected.
5. Select the addressing method of the PLC memory locations from the list box.
6. Select the number of the bit to be changed from the list box.

---

#### Note

In the S5 PLC, markers, inputs, and outputs can be addressed by byte, and data blocks (DB, DX) can be addressed by word.

---

### Setting the by Byte Access

1. Right mouse button click on the desired tag to open its pop-up menu, and select “Properties”.
2. Open the “General Information” tab and select the “Unsigned 8-Bit Value” or “Signed 8-Bit Value” data type.
3. Click on the “Select” button to open the “Address Properties” dialog.

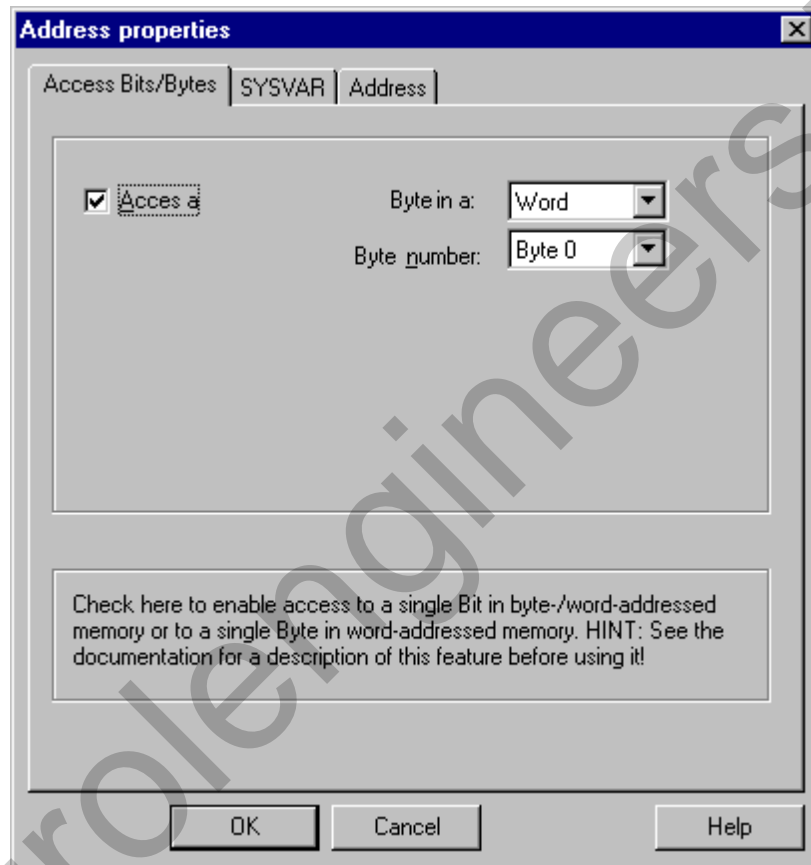

4. Via the checkbox, the “By Byte” accessing method can be selected.
5. Select the addressing method of the PLC memory locations from the list box.
6. Select the number of the bit to be changed from the list box.

### 4.2.3 Connection Parameters

The process driver connection by means of serial connection is possible with the SIMATIC S5 PLC. The AS 511 communication processor is used in the PLC.

No additional communication module is needed in the WinCC system. Communication takes place either by means of the TTY interface of a PG 760 programming device or by means of one of the standard COM ports in the system. In this case, a V.24/V.28 <---> TTY interface converter is necessary.

How to Configure the Communication Parameters:

1. Select the connection and use the pop-up menu to open the "Properties" dialog box.
2. Select the "AS511" tab.

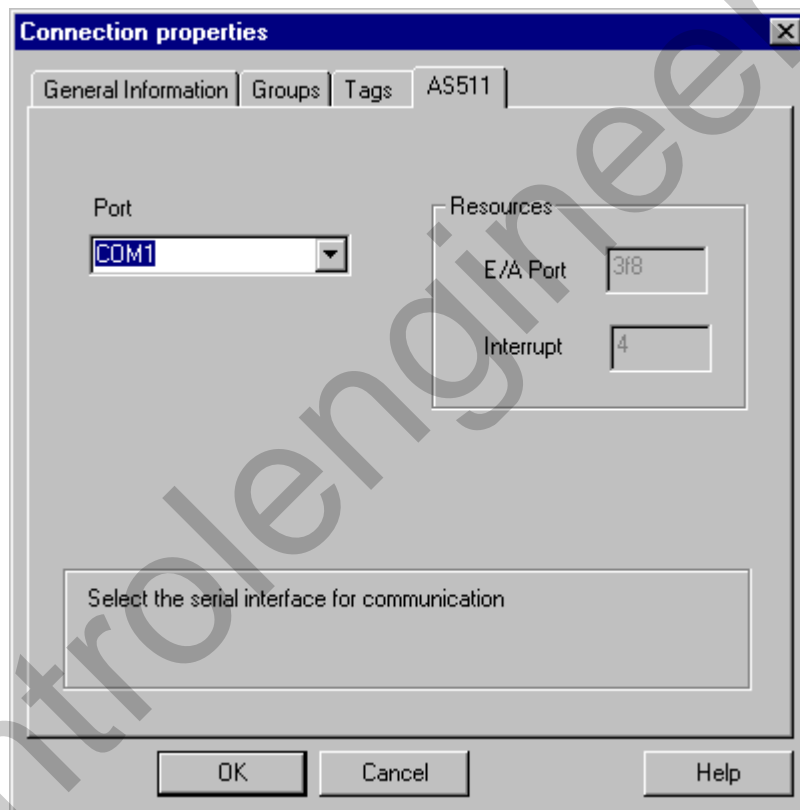

3. In the "Interface" box, select the communication interface (COM1 to COM4 or COMx) for serial connection.

---

#### Note

Only if you select "COMx" as the interface can you make entries manually in the "I/O Port" and "Interrupt" boxes in the "Resources" area. In all other cases, the software specifies these values.

---

## 4.3 SIMATIC S5 Ethernet Layer 4 Communication Driver

This communication driver is used for the connection to such PLCs as the SIMATIC S5-115U/H, SIMATIC S5-135U, and SIMATIC S5-155U/H by means of the ISO transport protocol.

### Channel Units

The communication driver has two channel units with which a maximum of two CP 1413s can be operated. The functionality of the channel units is identical. They differ only in their logical device names.

In the the following, we will only describe the communication with one CP1413. Beginning with WinCC V4.0, using SOFTNET communication is also possible via other cards (e.g.: CP 1411, CP1511, 3COM).

You can change the logical device name by means of the system parameters of the channel unit. Here you can also set the parameters for the ISO transport protocol.

The following applications are available:

- Channel Unit S5 Transport (CP 1413-1) for the communication modules for SIMATIC Industrial Ethernet (such as CP 1413).
- Channel Unit S5 Transport (CP 1413-2) for the communication modules for SIMATIC Industrial Ethernet (such as CP 1413).



### 4.3.1 System Parameters

The process driver connection by means of the Industrial Ethernet is possible with the SIMATIC S5-115U/H, S5-135U, and S5-155U/H PLCs. The communication module CP 1430 TF is used in the PLC. Communication takes place by means of the ISO transport protocol.

The communication module CP 1413 is used in the WinCC system. Because communication takes place via the ISO transport protocol, it is not necessary to configure the logical connection in the local database.

#### How to Configure the System Parameters:

1. Select the channel unit and use the pop-up menu to open the "System Parameters" dialog box.
2. Select the "Device Names" tab.

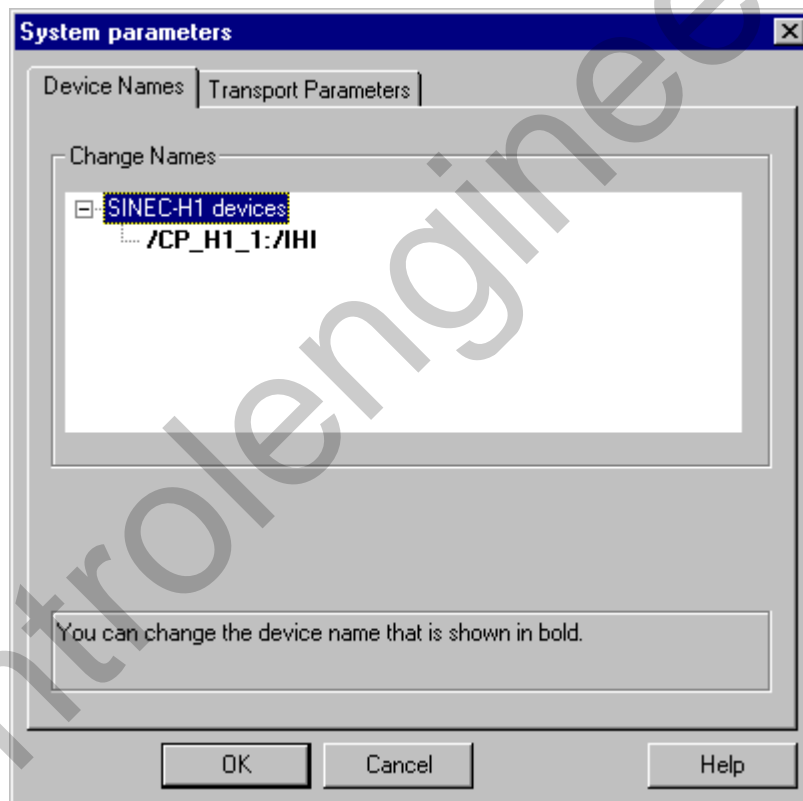

3. Select the device name displayed in bold type and click in the name box to change the device name.

#### Note

The device name is specified when the hardware driver is installed. Only if you assigned a different name then (which, however, is not a good idea) do you have to change the device name here also.

### System Parameters "Transport Parameter" Tab

1. Select the channel unit and open it via the pop-up menu in the "Transport Parameter" dialog.
2. Select the "Transport Parameters" tab.

3. Set the value in the "PDU Size" box to the value that was also configured on the CP 1430 TF.
4. In the "Setup Attempts" box, specify how often an attempt should be made to set up a connection.
5. In the "Duration of Send Repetitions" area, select "Infinite."
6. Enter e.g. the value 30 in "Acknowledgement Time", so that you will be informed after 30 seconds at the most about the status of the variables, if the communication partner has not answered within this time (e.g. AG in "Stop" state).

### 4.3.2 Data Type of the Tags

You define the tags necessary for a logical connection. The following data types are available in WinCC:

- Binary tag
- Unsigned 8-bit value
- Signed 8-bit value
- Unsigned 16-bit value
- Signed 16-bit value
- Unsigned 32-bit value
- Signed 32-bit value
- 32-bit IEEE 754 floating-point number
- Text tag, 8-bit character set
- Raw Data Type

### 4.3.3 Tag Address

You enter the tag address according to the address structure of SIMATIC S5.

Depending on the type of tag, access to the PLC's memory area will proceed by bit, byte or word. To do that, the addressed memory location is read from the PLC for every write request and the corresponding bits/bytes will be changed. Afterwards, the data range will be written back to the PLC. Changes to the read data, made by the PLC, will be overwritten during the write back.

---

**Note**

Changes to the read data, made by the PLC, will be overwritten during the write back.

---

The addresses for tags are assigned in accordance with the type of tag:

- For "binary" or "8-bit" tags, first the "Bit-/Byte - Tag" dialog will open in which you can specify that the access to the PLC memory area will be either bit or byte-wise. Afterwards, the "Address properties" dialog will open in which you can set the addresses of the tags in the PLC memory.
- In the case of word-oriented tags, the addresses of the tags in the PLC memory are set in the "Address properties" dialog. The "Bit-/Byte - Tag" dialog is not opened, since the PLC memory is accessed word-wise.

### 4.3.3.1 Entering the address of a tag

In the dialog described below, the tag address in the PLC will be set.

- For "binary" or "8-bit" tags, first the "Bit-/Byte - Tag" dialog will open in which you can specify that the access to the PLC memory area will be either bit or byte-wise.
- For word-oriented tags, the "Bit-/Byte - Tag" dialog will not open, since the tag addresses and thus the access to the PLC memory are made word-wise.

#### Entering the Tag Address:

1. Select the tag and use the pop-up menu to open the "Properties" dialog box.
2. In the "General Information" tab, select the desired data type (e.g. signed 16-bit value).
3. Click on the "Select" button. The "Address Properties" dialog window opens.

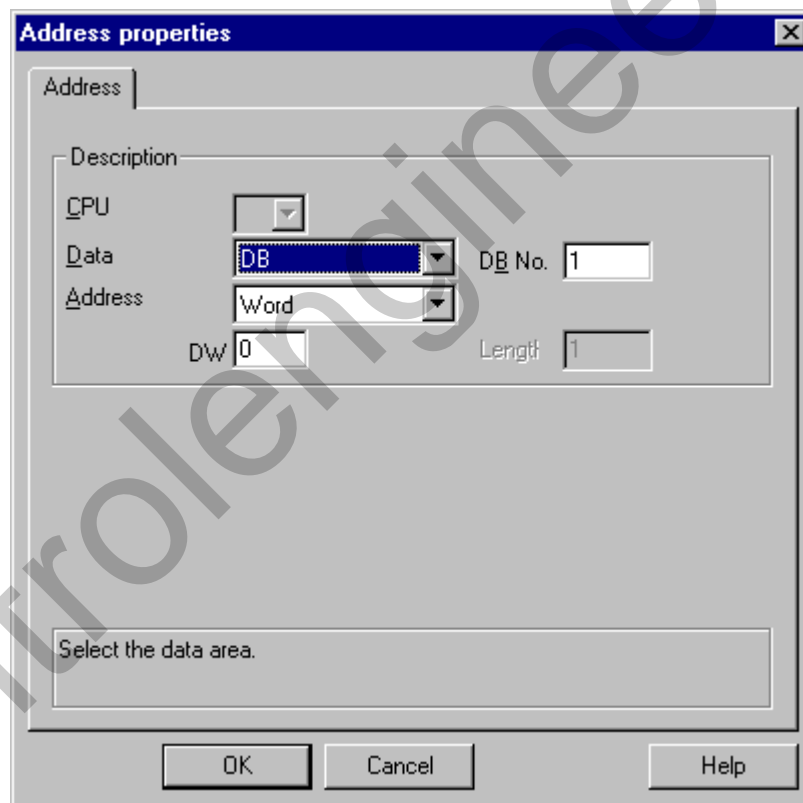

4. On the "Address" tab, in the "Data Area" box, select whether the tag is located in a data block, in an extended data block, in an input or output area.
5. If the tag is in a data block, the "DB No." box is also displayed. Enter the data block number in this field.
6. The "Addressing" box indicates the type of addressing. Normally, a preset can be accepted.
7. Enter the address in the corresponding field (e.g. "DW").

**Note**

For "binary" or "8-bit" tags, the values shown in the boxes in this dialog depend on the selections made in "Access Bits/Bytes" in the "Bit-/Byte - Tag" dialog box. If the tag of a word-oriented data area is to be written, the start address must be in the left byte and the length of the tag must be an even number.

**Entering the Address of a Raw Data Tag:**

1. Select the desired tag to open the associated pop-up menu and click on "Properties" to display the "Tag Properties" dialog box.
2. In the "General Information" tab, select "Raw Data Type" from the "Data Type" list box.
3. Click on the "Select" button in order to open the "Address Properties" dialog box.

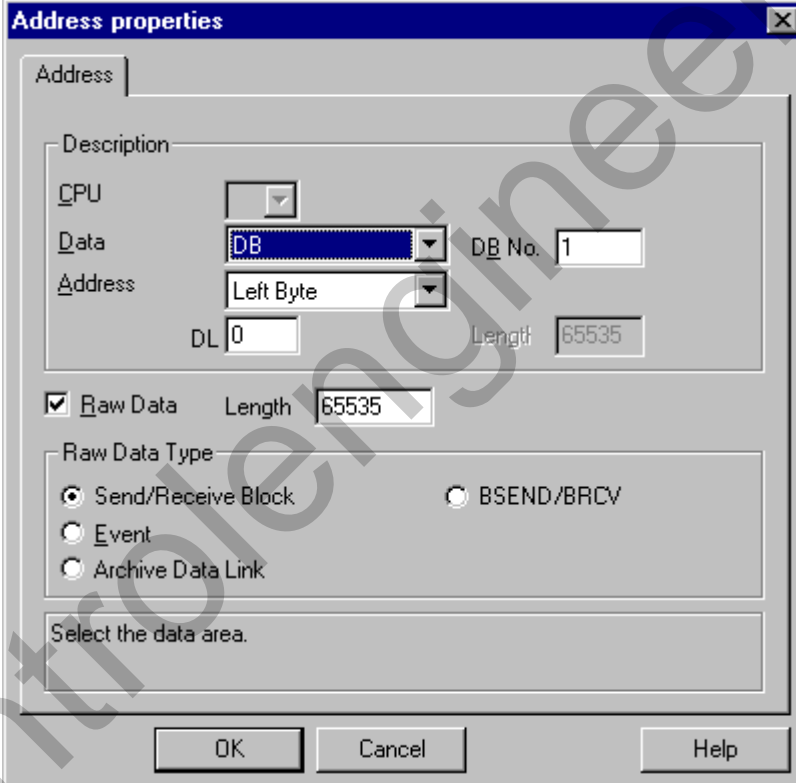
 The "Address properties" dialog box is shown. It has a title bar with "Address properties" and a close button. The "Address" tab is selected. The "Description" section contains:
 

- CPU:
- Data:  (dropdown menu)
- DB No.:
- Address:  (dropdown menu)
- DL:
- Length:

 The "Raw Data" checkbox is checked. The "Raw Data Type" section has three radio buttons:
 

- Send/Receive Block
- Event
- Archive Data Link
- BSEND/BRCV

 At the bottom, there is a "Select the data area." field and three buttons: "OK", "Cancel", and "Help".

4. In the "Data Area" field, select whether the tag is located in a data block, a bit memory (flag) area, or an input/output area.
5. If the tag is located in a data block, the "DB No." field will also be displayed. Enter the data block number in this field.
6. Specify the addressing mode in the "Addressing" field. In most cases the default can be accepted.
7. Enter the address in the corresponding field (e.g. "DBW").
8. Specify the length of the raw data block in the "Length" field.
9. Specify the type of the raw data in the "Raw Data Type" area.

### Set bit-wise access

1. Select the tag and use the pop-up menu to open the "Properties" dialog box.
2. Open the "General Information" tab and select the "Binary Tag" data type.
3. Click on the "Select" button. The "Bit-/Byte - Tag" dialog will open.

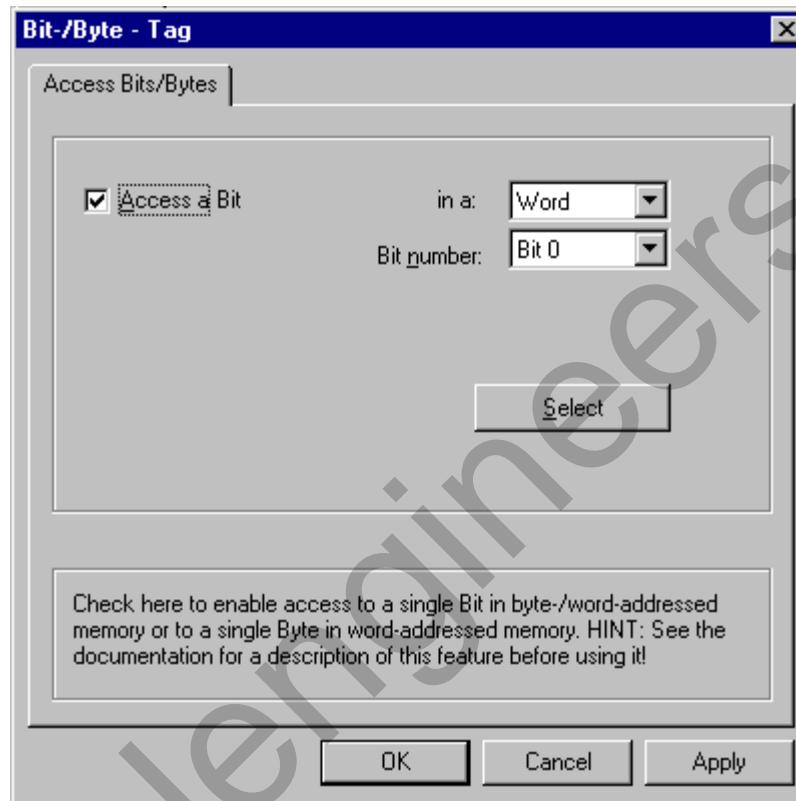

4. With this check box, you can determine whether specific bits in the memory area should be accessed, in other words can be read **and written**.
5. In the box, select the type of addressing for the PLC memory e.g. "Word" or "Byte".
6. In the "Bit number" field, select the number of the bit to be modified.
7. Click on the "Select" button to open the "Address properties" dialog in which the addresses of the tags in the PLC can be set.

#### Note

In the S5 PLC, markers, inputs, and outputs can be addressed by byte, and data blocks (DB, DX) can be addressed by word.

When the "Access a Bit" check box is marked, this changes the fields displayed in the "Address properties" dialog.

For word-oriented tags, the described "Bit-/Byte - Tag" dialog will not be opened, since the tag addresses and thus the access to the PLC memory are made word-wise.

### Set byte-wise access

1. Select the tag and use the pop-up menu to open the "Properties" dialog box.
2. Open the "General Information" tab and select the "Unsigned 8-Bit Value" or "Signed 8-Bit Value" data type.
3. Click on the "Select" button. The "Bit-/Byte - Tag" dialog will open.

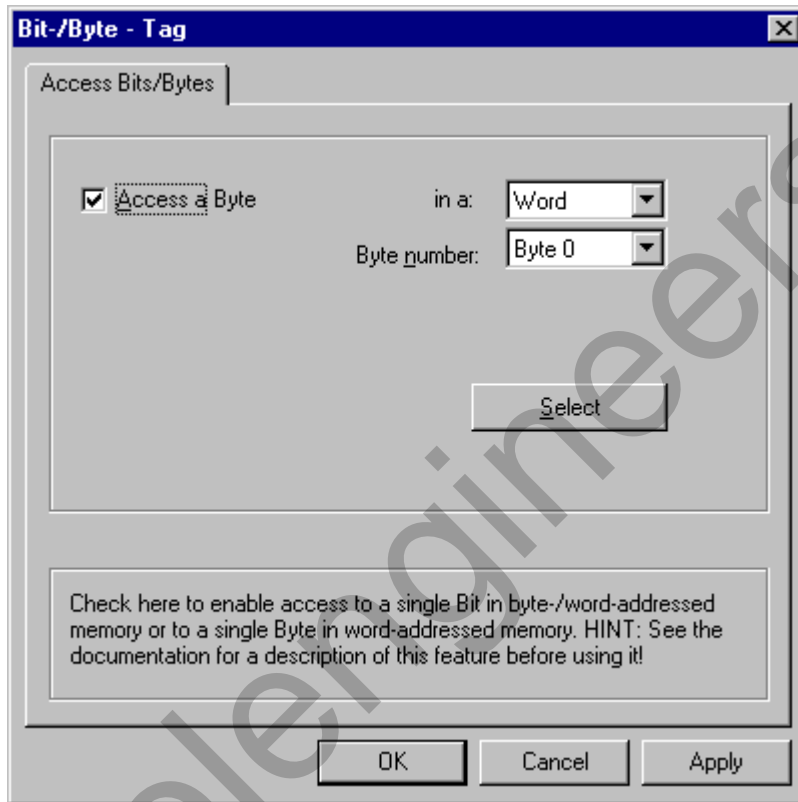

4. With this check box, you can determine whether specific bytes in memory should be accessed, in other words can be read **and written**.
5. The only option that will be displayed for the type of addressing to be used for the PLC memory is "Word".
6. In the "Byte number" field, select the number of byte to be changed.
7. Click on the "Select" button to open the "Address properties" dialog in which the addresses of the tags in the PLC can be set.

#### Note

In the S5 PLC, markers, inputs, and outputs can be addressed by byte, and data blocks (DB, DX) can be addressed by word.

When the "Access a Byte" check box is marked, this changes the fields displayed in the "Address properties" dialog.

For word-oriented tags, the described "Bit-/Byte - Tag" dialog will not be opened, since the tag addresses and thus the access to the PLC memory are made word-wise.

### 4.3.4 Connection Parameters

For a logical connection, WinCC sets up one connection each for reading (READ) and writing (WRITE) in the transport layer. The logical connection is not designated as set up until both of these connections have been established.

#### Configuring the Connection Parameters:

1. Select the connection and use the pop-up menu to open the "Properties" dialog box.
2. In the "General" panel, click on the "Properties" button and the "Connection parameters" dialog box will open.

3. In the "Ethernet Address Controller" box, enter the station address of the SIMATIC S5 on the Industrial Ethernet bus.
4. Specify the parameters for the READ function in the WinCC system. They depend on the request used in the SIMATIC S5.

WinCC Side	SIMATIC S5 Side
FETCH Active (Request "READ Active")	READ Passive (Request "READ Passive")
FETCH Passive (Request "WRITE Passive")	WRITE Active (Request "WRITE Active")

5. In the "Own TSAP-ID" box, enter the value that was configured for the CP 1430 TF as "TSAP" under the heading of "Remote Parameters."



6. In the "Ext. TSAP-ID" box, enter the value that was configured for the CP 1430 TF as "TSAP" under the heading of "Local Parameters."
7. Enter the appropriate parameters for "Own TSAP-ID" and "Ext. TSAP-ID" for the WRITE function.

WinCC Side	SIMATIC S5 Side
Request "WRITE Active"	Request "WRITE Passive"

controlengineers.ir

## 4.4 SIMATIC S5 Ethernet TF Communication Driver

This communication driver is used for the connection to the SIMATIC S5-115U/H, SIMATIC S5-135U, and SIMATIC S5-155U/H PLCs by means of the Industrial Ethernet with the TF (Technological Functions) protocol.

### Channel Unit

The communication driver has a channel-unit to operate the CP 1413. You can change the logical device name by means of the system parameters of the channel unit.

The following application is available:

- Channel unit S5 application (CP 1413-1) for the communication modules for SIMATIC NET Industrial Ethernet (for example, CP 1413).

#### 4.4.1 System Parameters

The process driver connection by means of Industrial Ethernet is possible with the SIMATIC S5-115U/H, S5-135U, and S5-155U/H PLCs. The communication module CP 1430 TF is used in the PLC. Communication takes place by means of the TF protocol.

The communication module CP 1413 is used in the WinCC system. The logical connection must be configured in the local database.

##### How to Configure the System Parameters:

1. Select the channel unit and use the pop-up menu to open the "System Parameters" dialog box.
2. The "System Parameters" dialog box with the "Device Names" tab opens.

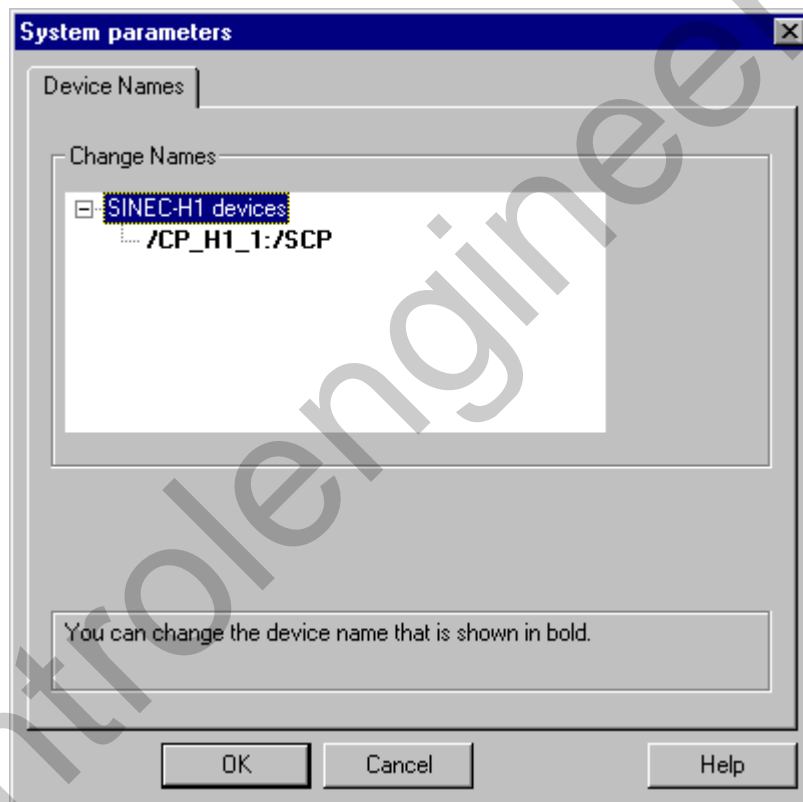

3. Select the device name displayed in bold type and click in the name box to change the device name.

##### Note

The device name is specified when the hardware driver is installed. Only if you assigned a different name then (which, however, is not a good idea) do you have to change the device name here also.

#### 4.4.2 Data Type of the Tags

You define the tags necessary for a logical connection. The following data types are available in WinCC:

- Binary tag (read only)
- Unsigned 8-bit value (read only)
- Signed 8-bit value (read only)
- Unsigned 16-bit value
- Signed 16-bit value
- Unsigned 32-bit value
- Signed 32-bit value
- 32-bit IEEE 754 floating-point number
- Text tag, 8-bit character set
- Raw data type

Controlengineers.ir

### 4.4.3 Tag Address

You enter the tag address according to the address structure of SIMATIC S5.

#### Entering the Tag Address:

1. Select the tag and use the pop-up menu to open the "Properties" dialog box.
2. In the "General Information" tab, select the desired data type (for example, signed 32-bit value).
3. Click on the "Select" button. The "Address Properties" dialog window opens.

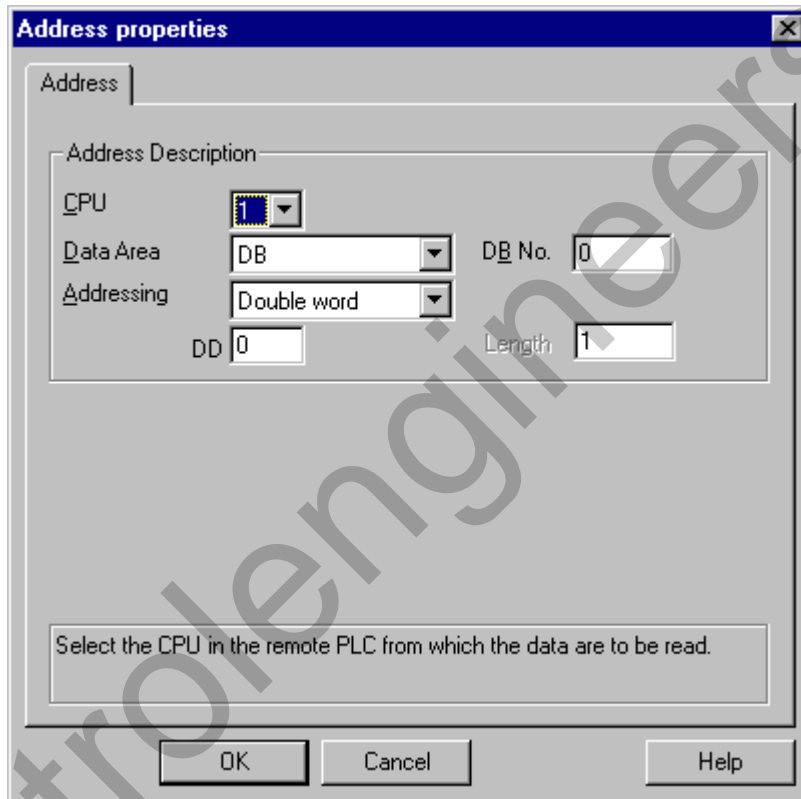

4. In the "CPU" box, select the CPU in which the data area for the tag is located.
5. In the "Data Area" box, select whether the tag is located in a data block, in an extended data block, in a bit memory (flag) area, or in an input or output area.
6. If the tag is in a data block, the "DB No." box is also displayed. Enter the data block number in this field.
7. The "Addressing" box indicates the type of addressing. In most cases the default can be accepted.
8. Enter the address in the appropriate box (for example, "DD").

---

#### Note

If the tag of a word-oriented data area is to be written, the start address must be in the left byte and the length of the tag must be an even number.

---

### Entering the Address of a Raw Data Tag:

1. Select the desired tag to open the associated pop-up menu and click on "Properties" to display the "Tag Properties" dialog box.
2. In the "General Information" tab, select "Raw Data Type" from the "Data Type" list box.
3. Click on the "Select" button in order to open the "Address Properties" dialog box.

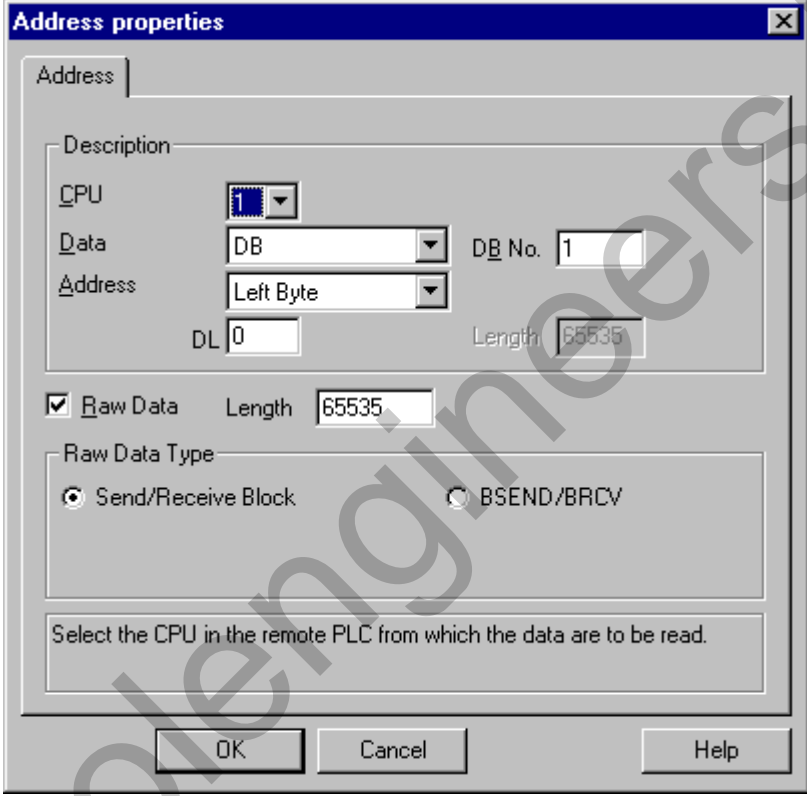

4. In the "Data Area" field, select whether the tag is located in a data block, a bit memory (flag) area, or an input/output area.
5. If the tag is located in a data block, the "DB No." field will also be displayed. Enter the data block number in this field.
6. Specify the addressing mode in the "Addressing" field. In most cases the default can be accepted.
7. Enter the address in the corresponding field (e.g. "DBW").
8. Specify the length of the raw data block in bytes in the "Length" field.
9. Specify the type of the raw data tag in the "Raw Data Type" area .

#### 4.4.4 Connection Parameters

Configuring the Connection Parameters:

1. Select the connection and use the pop-up menu to open the "Properties" dialog box.
2. In the "General" panel, click on the "Properties" button and the "Connection parameters" dialog box will open.

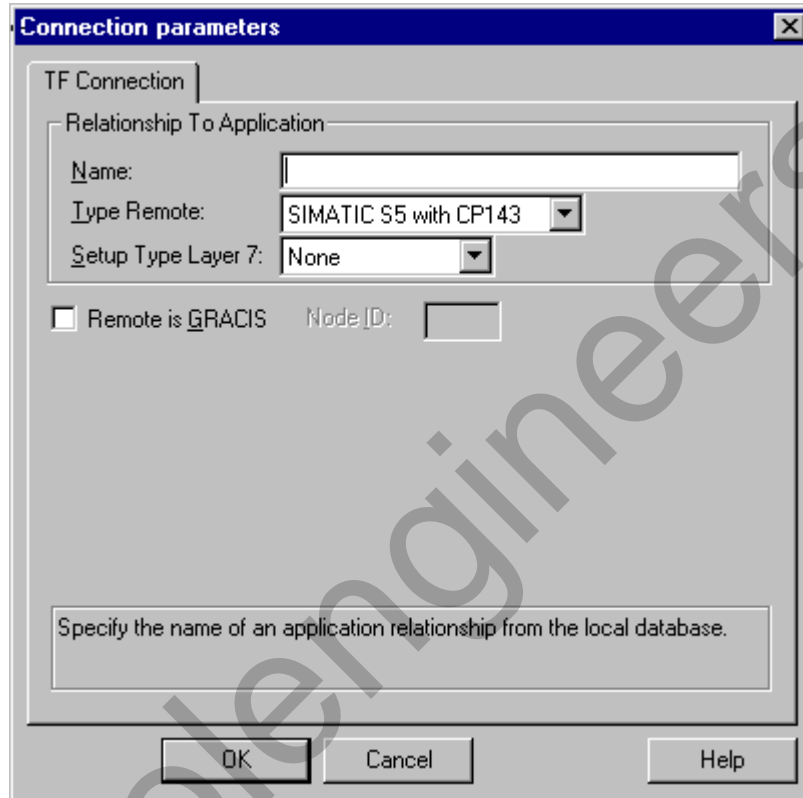

3. In the "Name" box, enter the name of the application relationship.

#### Note

The name of the application relationship must be configured in the WinCC system in the local database. To do this, use the "COML 1413 TF" program from the "TF-NET 1413/Windows 95" or "TF-NET 1413/Windows NT" package. You also specify your own TSAP-IDs and external TSAP-IDs here. For example, for a connection to SIMATIC S5, these IDs must correspond to the "TSAP" values under the headings "Remote Parameters" and "Local Parameters" from the configuration of the CP 1430 in SIMATIC S5.

4. In the "Type Remote" box, select the remote PLC for communication.
5. In the "Setup Type Layer 7," specify the connection that should be set up in the application layer.

---

**Note**

This value must be configured similarly in the remote PLC system.

---

The following variants in setup type are permitted:

WinCC	Remote PLC System
None	None
Active	Passive
Passive	Active

6. Select the check box "Remote is GRACIS" in case the remote PLC system is a GRACIS system and enter the "Node ID" in the appropriate box.

Controlengineers.ir



## 4.5 SIMATIC S7 Protocol Suite Communication Driver

The communication driver is used for connecting to the SIMATIC S7-300 and SIMATIC S7-400 PLCs.

### Channel Units

Five different channel units are available. Depending on the installed WinCC communication hardware, the following applications are supported:

- Industrial Ethernet and Industrial Ethernet (II) for the SIMATIC NET Industrial Ethernet communications modules (e.g. CP 1413).
- MPI for connecting via an internal MPI interface (e.g. PG 760/PC RI45) or MPI module, as well as the CP 5511 communications component (PCMCIA card),
- Named Connections are used to set up symbolic connections configured via Step7. These symbolic connections, for example, are required for a highly available communication to the S7-400 PLC in conjunction with the redundancy in H/F systems.
- PROFIBUS and PROFIBUS (II) for the SIMATIC NET PROFIBUS communications modules (e.g. CP 5412/A2).
- Slot PLC for communication with the PLC card, which is a PC card located in your PC.
- TCP/IP for communication via networks using a TCP/IP protocol.

## 4.5.1 System Parameters

### 4.5.1.1 Channel Tab

In this tab, specific system parameters for all computer-local S7 channel units are defined. These settings are not project-specific. This tab is structured identically for all S7 channels. For illustrative purposes, we will use the "MPI" card.

Field	Description
Use Cyclic Read Service of PLC	If set, the cycle formation is activated by the channel while the tags are read. The cyclic services of the PLC will be used, if they are available.
Activate (Life Beat Monitoring)	If set, life beat monitoring will be activated.
Interval	Time interval in seconds for the sending of life beat telegrams. Value Range: 10 - 600 sec.
Monitoring Interval	Monitoring interval in seconds for the reply to a sent life beat telegram. If no reply is received during this interval, the channel will terminate the connection. Value Range: 5 - 600 sec.
Activate (Monitoring of CPU-Stop)	If set, the S7-CPU will be monitored for stoppages. If a stoppage occurs, the connection will be terminated.

Changes made to parameter values will only become effective after a restart of WinCC. The system will display a corresponding information dialog box, if the system parameters dialog box is exited.

### 4.5.1.2 Unit Tab

In this tab, unit-specific system parameters are defined.

This tab is structured identically for all S7 channels. For illustrative purposes, we will use the "MPI" card.

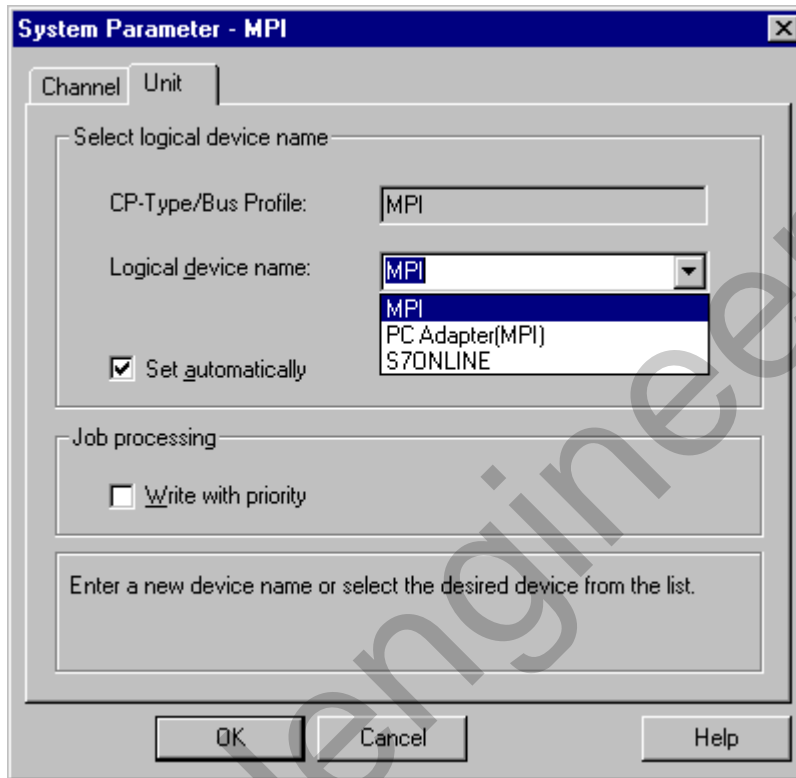

Field	Description
CP-Type/Bus Profile	The type of the selected channel unit is displayed here.
Logical Device Name	The logical device name can either be selected from the drop-down list or entered directly. The device names displayed in the drop-down list are determined by the "Setting the PG/PC Interface" (Control Panel) tool.
Set Automatically	If set, a check will be performed at the start of runtime, which determines if only one communication card has been installed for this communication type. If this is the case, the configured name of the channel unit will be replaced by the existing one.
Write with Priority	If set, write requests will be processed with a higher priority than read requests.

## Logical Device Names

The communication to the S7 takes place via logical device names. This name is assigned during the installation of the communication card. Depending on the installed communication card, the following name conventions have been established:

- Industrial Ethernet Unit: CP\_H1\_1
- Industrial Ethernet Unit (II): CP\_H1\_2
- MPI Unit: MPI
- Named Connections Unit: VM/
- PROFIBUS Unit: CP\_L2\_1
- PROFIBUS Unit (II): CP\_L2\_2
- Slot PLC Unit: SLOT-PLC
- TCP/IP Unit: CP-TCPIP

Should your communication card not support these name conventions, the preset logical device names can be changed via the system parameters of the channel unit.

## How to change the logical device name of a channel unit

The dialog boxes for setting the system parameters are structured identically for all types of channel units. For illustrative purposes, we will describe the "System Parameters - MPI" dialog box.

---

### Note

A description of the fields contained in this tab can be found under "Unit Tab" of the system parameters.

---

1. Select the "MPI" channel unit and open the "System Parameters" dialog box via the pop-up menu.
2. Select the "Unit" tab.
3. The "Logical Device Name" entry field displays the current name, e.g. "MPI". A new name can be entered directly or be selected from the drop-down list of possible device names. Confirm the changed name by clicking on the "OK" button.

If a logical device name is entered that is not contained in the provided drop-down list, an information dialog box will be displayed by the system.

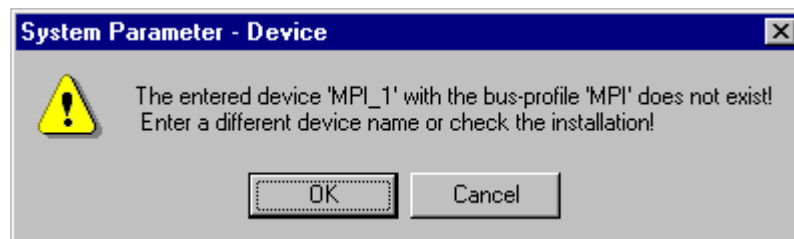

The device names that can be selected from the drop-down list are determined by the "Setting the PG/PC Interface" (Control Panel) tool.

If this tool is not installed, only the currently set device name is displayed. If you specify another logical device name, an information dialog box will be displayed.



#### 4.5.2 Data Type of the Tags

Define the necessary tags for a logical connection. The following data types are available in WinCC:

- Binary tag
- Unsigned 8-bit value
- Signed 8-bit value
- Unsigned 16-bit value
- Signed 16-bit value
- Unsigned 32-bit value
- Signed 32-bit value
- 32-bit IEEE 754 floating-point number
- 64-bit IEEE 754 floating-point number
- Text tag, 8-bit character set
- Text tag, 16-bit character set
- Raw data type.

### 4.5.3 Address of the Tag

The tag address is entered according to the address structure of the SIMATIC S7.

The structure of the "Address Properties" dialog box is dependent on the tag type. If the tag is of the "Raw Data" type, the dialog box contains additional entry fields.

#### Entering the address of a tag:

1. Select the tag and click on "Properties" from its pop-up menu to open the "Tag Properties" dialog box.
2. In the "General Information" tab, select the desired data type (e.g. signed 16-bit value).
3. The "Select" button opens the "Address Properties" dialog box.

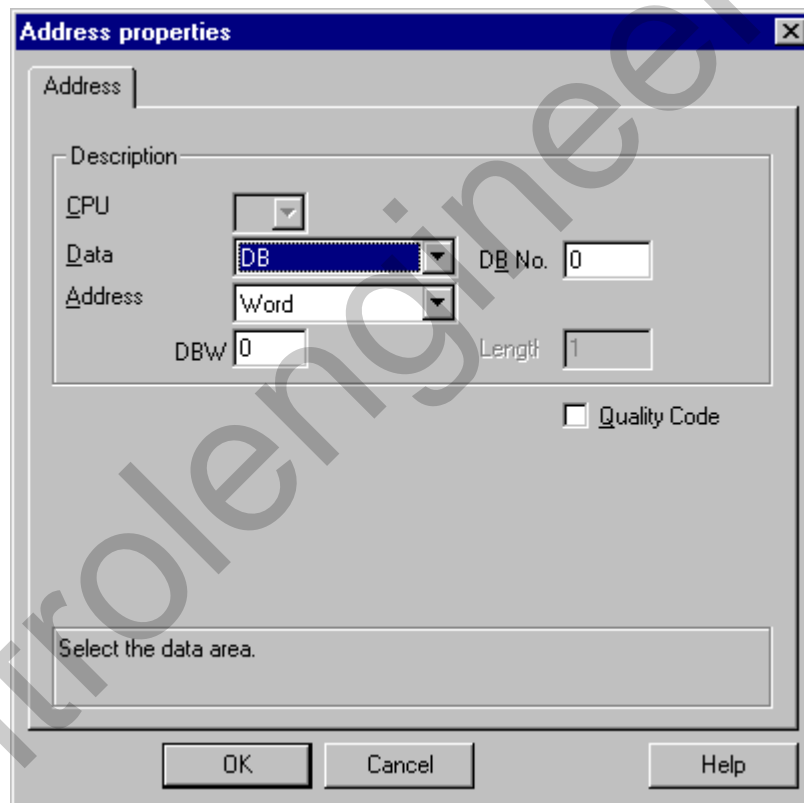

4. In the "Data (Area)" field, specify whether the tag is located in a data block (DB), flag area, input or output area.
5. If you select DB, the "Db No." entry field will be displayed in addition. Enter the data block number in there.
6. In the "Address" field, specify the addressing type. Normally, the default can be accepted.
7. In the field below, enter the data address. The content of this field depends on the tag type, e.g. "DBW" for the "signed 16-bit value" type.
8. If the tag is of the "Binary" type, enter the bit address in the "Bit" field.

9. If the tag includes a "Quality Code" which is going to be used in WinCC, activate the check-box of the same name. To do so, the code must also be provided from the S7 side.

#### Entering the Address of a Raw Data Tag:

1. Select the desired tag to open the associated pop-up menu and click on "Properties" to display the "Tag Properties" dialog box.
2. In the "General Information" tab, select "Raw Data Type" from the "Data Type" list box.
3. Click on the "Select" button in order to open the "Address Properties" dialog box.

4. In the "Data Area" field, select whether the tag is located in a data block, a bit memory (flag) area, or an input/output area.
5. If the tag is located in a data block, the "DB No." field will also be displayed. Enter the data block number in this field.
6. Specify the addressing mode in the "Addressing" field. In most cases the default can be accepted.
7. Enter the address in the corresponding field (e.g. "DBW").
8. If applicable, specify the length of the raw data block in the "Length" field.

---

### Note

The length of the raw data is limited to one data block, i.e. it must be possible to completely transfer one raw data block within one PDU (Protocol Data Unit).

The length of the data blocks that can be transmitted by the S7 communications driver depends on the block length specified during connection setup minus the header and additional information. The following PDU lengths are currently used for SIMATIC S7:

- PDU length 240 Bytes (S7-300): raw data block maximum 208 Bytes
- PDU length 480 Bytes (S7-400): raw data block maximum 448 Bytes

If you use an S7-5412 with an SAPI S7, the raw data block length is limited to a maximum of 224 Bytes!

If an invalid block length is entered, a message will be displayed indicating that your read/write request has been rejected.

---

## 4.5.4 The Raw Data Tags of the S7 Communications Driver

In addition to the process tags, the data manager also administrates rawdata tags. The S7 communications driver distinguishes two types of raw data tags.

- Raw data tag for a user-defined application (e.g. BSEND/BRCV data blocks)
- Raw data tag for processing S7 functions (e.g. message processing)

The raw data tags for processing S7 functions contain an S7-specific header and are generally used by the WinCC message and the process data recording systems. To use raw data tags for processing S7 functions, an S7 PMC license is required.

The raw data tags for user-defined applications are used to transfer user data blocks from and to the PLC. These raw data tags only handle user data.

### 4.5.4.1 Raw Data Tags for User-Defined Applications:

The S7 communications driver currently supports two functionalities for raw data tags for user-defined applications:

- Raw data tag as Byte array
- Raw data tag for BSEND/BRCV functions



#### 4.5.4.2 Raw Data Tag as Byte Array

A raw data tag which comes as a Byte array corresponds to a regular process tag in the eyes of the S7 channel. It is handled like a process tag by the S7 channel.

The maximum length of the data blocks that can be transmitted by the S7 communications driver depends on the block length specified during connection setup minus the header and additional information. With PDU lengths typically used by S7, this results in the following maximum lengths:

- PDU length 240 Bytes (usual for S7-300): 208 Bytes
- PDU length 480 Bytes (usual for S7-400): 448 Bytes

Warning: If the SAPI-S7 is used, the maximum data block is limited to 224 Bytes!

If larger data blocks are to be transferred, the user himself must create suitable data blocks.

#### Configuring a Raw Data Tag as a Byte Array

The raw data tags for transferring data blocks are configured as raw data of the “send/receive block” type and include an address and a length indication.

Example of a configuration for a data area 40 Bytes long in data block 100, starting from data word 20:

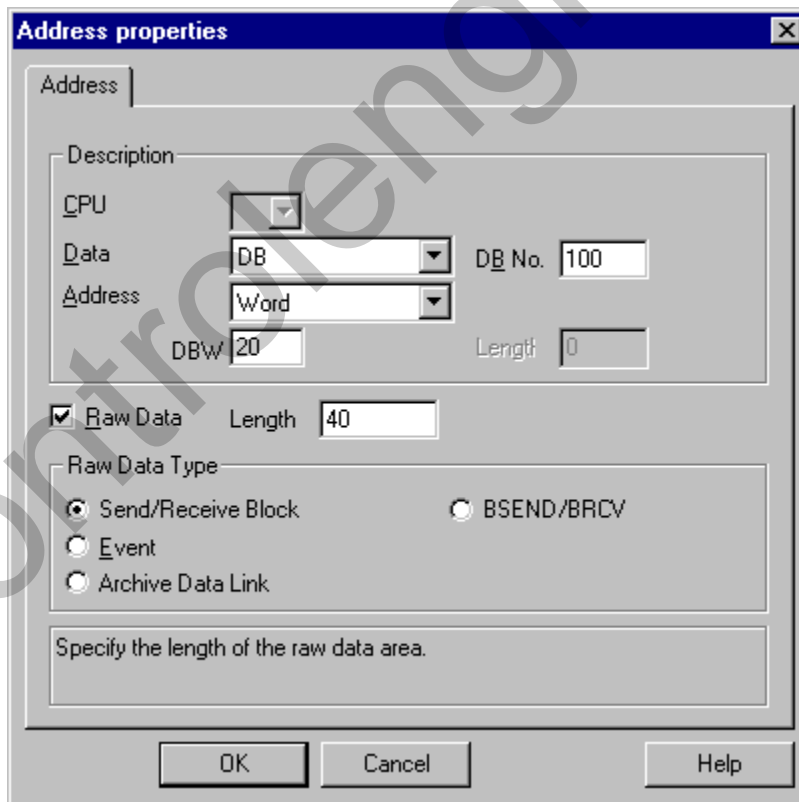

### Reading a Raw Data Tag as a Byte Array

The process of reading a raw data tag as a Byte array is the same as reading an 'ordinary' process tag. The corresponding data block is requested from the PLC and passed on to the user, once the data have been received. A transmission of this type is always initiated by WinCC. Sporadic or event-driven data reception initiated by the PLC is not possible by means of this raw data tag.

### Writing a Raw Data Tag as a Byte Array

The process of writing a raw data tag as a Byte array is the same as writing an 'ordinary' process tag. After the data block has been transmitted and a positive acknowledgement has been received from the PLC, the data block is transferred to the data manager image. Since this represents a tag modification, all applications that have requested to modify these tags are continued with the value just written.

#### 4.5.4.3 Raw Data Tag for S7 Communication with BSEND/BRCV Functions

This type of raw data tag enables you to use the functions BSEND/BRCV of the S7 communication. These functions are currently only available for the S7-400 (not for the S7-300). The BSEND/BRCV functions enable you to exchange data blocks having a length of up to 16 Kilobytes with the PLC via S7 DOS. The partner sending data always initiates the data transfer, which allows the realization of sporadic or event-driven data block transfers using the BSEND/BRCV functions.

The BSEND/BRCV functionality is not supported by the SAPI S7.

---

#### Note

If the data block of a write job has been transferred to the PLC, a subsequent write job will be rejected with an error message if the previous write job has not been completely deleted from the receive buffer.

If such an error message is displayed, write jobs with a  $R\_ID > 0x80000000$  will be placed in a connection-specific waiting queue and attempts are made for approx. 6 seconds to repeat the write job. The chronological coordination of the transfer lies with the user and must be observed for write jobs with short intervals.

---

### Configuring a BSEND/BRCV Connection

The BSEND/BRCV functions can only be used via a permanent connection. To configure a permanent connection, a connection resource (Hexa: 10 ... DF) must be specified. This connection resource will be assigned by STEP7 when the connection is configured within the PLC. On the PLC side, the connection must be configured as a passive connection end point.

Example of a connection configuration for an H1 connection:

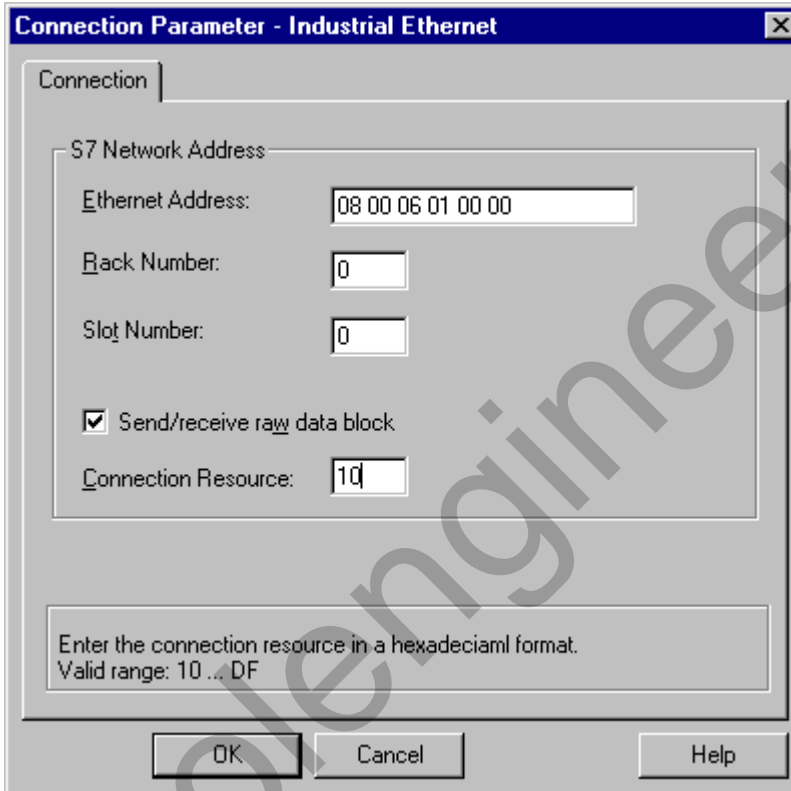

Connection Parameter - Industrial Ethernet

Connection

S7 Network Address

Ethernet Address: 08 00 06 01 00 00

Rack Number: 0

Slot Number: 0

Send/receive raw data block

Connection Resource: 10

Enter the connection resource in a hexadecimal format.  
Valid range: 10 ... DF

OK Cancel Help

Via a permanent connection it is also possible to process 'ordinary' read and write requests. If very large data areas are transferred, the data blocks will be transferred in multiple PDUs. For performance reasons, it is therefore recommended to create a dedicated connection for the BSEND/BRCV functions.

#### 4.5.4.4 Raw Data Tags for BSEND/BRCV Functions

The raw data tags for transferring BSEND/BRCV data blocks are configured as raw data of the 'BSEND/BRCV' type with an 'R\_ID'. The data length results implicitly from the sent/received data amount.

Example of a configuration of a BSEND/BRCV raw data tag:

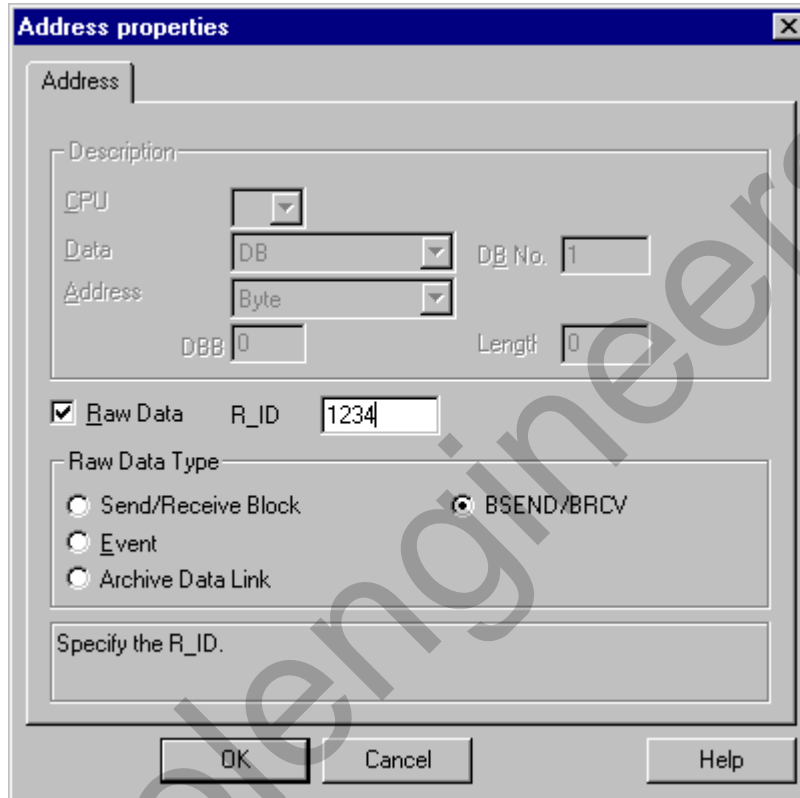

The screenshot shows the 'Address properties' dialog box. The 'Address' tab is active. In the 'Description' section, the following values are set: CPU (dropdown), Data (DB), DB No. (1), Address (Byte), DBB (0), and Length (0). The 'Raw Data' checkbox is checked, and the 'R\_ID' field contains the value '1234'. Under 'Raw Data Type', the 'BSEND/BRCV' radio button is selected. At the bottom, there are 'OK', 'Cancel', and 'Help' buttons.

For the BSEND/BRCV functionality, a 32 Bit long R\_ID must be specified in hexadecimal format. The R\_ID serves for distinguishing multiple data block transfers which are processed via a single connection. The send and receive calls to the subordinate communications sub-system (S7DOS) are always indicated in reference to the R\_ID. A raw data tag, therefore, is always assigned to a unique R\_ID. For resource reasons, the number of BSEND/BRCV raw data tags should be kept small.

#### Receiving a BSEND/BRCV Raw Data Tag

BSEND/BRCV raw data are sporadically sent to the communications driver, which is initiated by the PLC. An explicit reading of S7 raw data tags is therefore not possible.

The BSEND/BRCV functionality contains no synchronization functions. If, in the start-up stage, no user has logged on to receive the data, the data blocks sent by the PLC will be discarded. The user has to take care of the synchronization himself, e.g. enable the sending direction to the PLC by setting a flag in a data word.

### Sending a BSEND/BRCV Raw Data Tag

The process of sending a BSEND/BRCV raw data tag is the same as writing an ‘ordinary’ process tag. After the data block has been transmitted and a positive acknowledgement has been received from the PLC, the data block is transferred to the data manager image.

### 4.5.5 Data Exchange with S7 Function Blocks (AR\_SEND)

In order to transfer process data into a WinCC measured value archive via the function block SFB 37 "AR\_SEND" integrated in the S7 CPU, the data must first be converted to a WinCC-specific format. In this case, one "AR\_SEND" block can supply one or multiple archive tags with data.

Such a data telegram can consist of one or multiple data blocks, where each data block contains two areas:

- The header contains information pertaining to the cycle, the process values and possibly a time stamp.
- The user data area contains the actual process values. The size of the user data area is limited to a maximum of 16000 bytes.

**Note**

In the data block representations, each line represents two BYTES. Process values, depending on the data type, can be one or multiple BYTES long.

Header Type				Header Type	
Year		Month		Time Stamp	
Day		Hours			
Minutes		Seconds			
1/10 s	1/100 s	1/1000 s	Day of Week	Header	
Cycle				Cycle-information	
Unit (Type)		Unit (Area)		Archive ID	
AR_SEND-Subnumber				Information	
Data Type of Process Values				Process Values	
Number of following Process Values				Process Values	
First Process Value				User Data Area	
Second Process Value					
Last Process Value					

## Header Type

The header type defines the information contained in the header.

Header Type	Description
0	Header without time stamp and without "AR_SEND" subnummer
1	Header with time stamp and without "AR_SEND" subnummer
8	Header without time stamp and with "AR_SEND" subnummer
9	Header with time stamp and with "AR_SEND" subnummer

## Time Stamp

The time stamp contains the date and time in the SIMATIC S7-BCD format. The indication of the weekday is not evaluated by WinCC.

## Cycle

Cycle, in which the process values are read, in time units.

## Unit (Type)

No.	Description
1	The process values are read equidistantly.
2	Each process value contains a time stamp.
3	Each process value contains a time difference in time units.

## Unit (Range)

Indicates the size of the time unit used for unit (type) = 3.

No.	Description
1	Reserved
2	Reserved
3	Milliseconds
4	Seconds
5	Minutes
6	Hours
7	Days

## AR-SEND Subnummer (AR\_ID Subnummer)

Establishes the assignment between the PLC user data and the WinCC archive tags. The subnummer is only of relevance for the header types 8 or 9. Valid values for the subnummer are in the range of 1 - 0FFF (hex). Die AR\_SEND subnummer replaces all previous archive information.

### Data Type of the Process Data

The process values are stored directly in the S7 format.

No.	S7 Data Type	WinCC Data Type
0	BYTE	BYTE
1	WORD	WORD
2	INT	SWORD
3	DWORD	DWORD
4	DINT	SDWORD
5	REAL	FLOAT

### Number of the transferred Process Values

Depending on the unit (type) entry, a certain number of process values can be transferred.

Unit (Type)	Relevance for the Process Values
1	Equidistant reading of the process values: The maximum size of the user data area is 16000 bytes. This permits the transfer of 8000 process values of the WORD/INT data type, or 4000 values of the DWORD/DINT/REAL data type. A time stamp must be specified in the header.
2	Process values with time stamp: Each element in the user data area consists of a time stamp (8 bytes) and a value. This permits the transfer of 1600 process values of the WORD/INT data type, or 1333 values of the DWORD/DINT/REAL data type. A time stamp specified in the header will not be evaluated.
3	Process values with time difference: Each element in the user data area consists of a time difference (4 bytes) and a value. This permits the transfer of 2666 process values of the WORD/INT data type, or 2000 values of the DWORD/DINT/REAL data type. A time stamp must be specified in the header.
4	Process value contains "AR_SEND" subnumber ("AR-SEND" with multiple tags - optimized) Each process value consists of a word with the "AR_SEND" subnumber (value range: 1 - 0x0FFF) and a value. The time stamp entered in the header applies as the date/time stamp for the process value. Therefore, the user data area consists of an array of process values with preceding "AR_SEND" subnumber. Because of the data block limitation to 16000 bytes, 3992 process values of the WORD/INT data type or 2660 process values of the DWORD/DINT/REAL data type can be transferred. A time stamp in the header is required.

#### 4.5.5.1 Configuration of "AR\_ID" and "AR\_SEND" Subnumber

The "Process Controlled Tag Properties" dialog box contains a dialog box for the conversion DLL, in which the "AR\_ID" and "AR\_SEND" subnumber ("AR\_ID" subnumber) is entered.

Archive tags can also be configured without "AR\_SEND" subnumber, by leaving the "Subnumber" check-box unmarked. All archive tags configured in WinCC V4.02 or lower, do not have an "AR\_SEND" subnumber.

##### How to configure the "AR\_ID" and "AR\_SEND" Subnumber:

1. In Tag Logging, select a process value archive. In the data window, open the pop-up menu of the process value archive and select "New Process Controlled Tag".
2. Display the "Process Controlled Tag Properties" dialog box by clicking on "Properties" from the pop-up menu.
3. The conversion DLL field should contain the entry "nrms7pmc.dll". Click on the "Options" button next to the field.

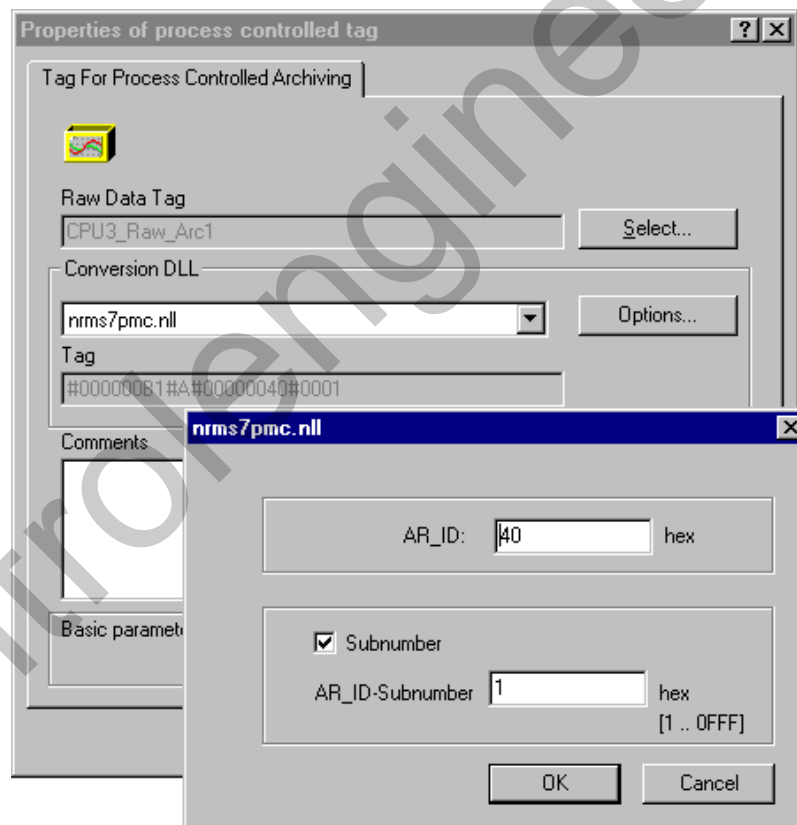

4. In the following dialog box, the "AR\_ID" and the "AR\_ID" subnumber can be entered in hexadecimal format, or be edited.  
If the archive tag contains no subnumber, deactivate the "Subnumber" check-box.



#### 4.5.5.2 Data Exchange with "AR\_SEND" for an Archive Tag

The data area to be transferred consists of a data block.  
 As the "AR\_SEND" subnumber, the number zero is assumed.  
 The archive tag name in WinCC contains no "AR\_SEND" subnumber.

Example of a Data Area Structure

**AR\_SEND-User Data**  
 AR\_ID = 0x40

Header Type = 0 or 1			
Year		Month	
Day		Hours	
Minutes		Seconds	
1/10 s	1/100 s	1/1000 s	Day of Week
Cycle			
Unit (Type)		Unit (Area)	
AR_SEND-Subnumber = 0			
Data Type of Process Values			
Number of following Process Values = i			
Process Value 1			
Process Value 2			
...			
Process Value i			

**Process Value Archive WinCC**

Archive Tag Name #00000123#A#00000040
Process Values 1 to i



#### 4.5.5.3 Data Exchange with "AR\_SEND" for multiple Archive Tags

This model allows you to supply one or multiple archive tags with process values. Therefore, the data area to be transferred can consist of one or multiple data blocks. The date/time stamp for the individual value of an archive tag is accepted from the data area or based on it and then transferred to the WinCC measured value archive, depending on the specified unit (type and area).

- For each "AR\_SEND" subnumber, a data block must be established in the data area.
- Header Type = 8 or 9, i.e. with/without time stamp and with "AR\_SEND" subnumber
- "AR\_SEND" subnumber = 0 is invalid for the header types 8 or 9.

## Example of a Data Area Structure

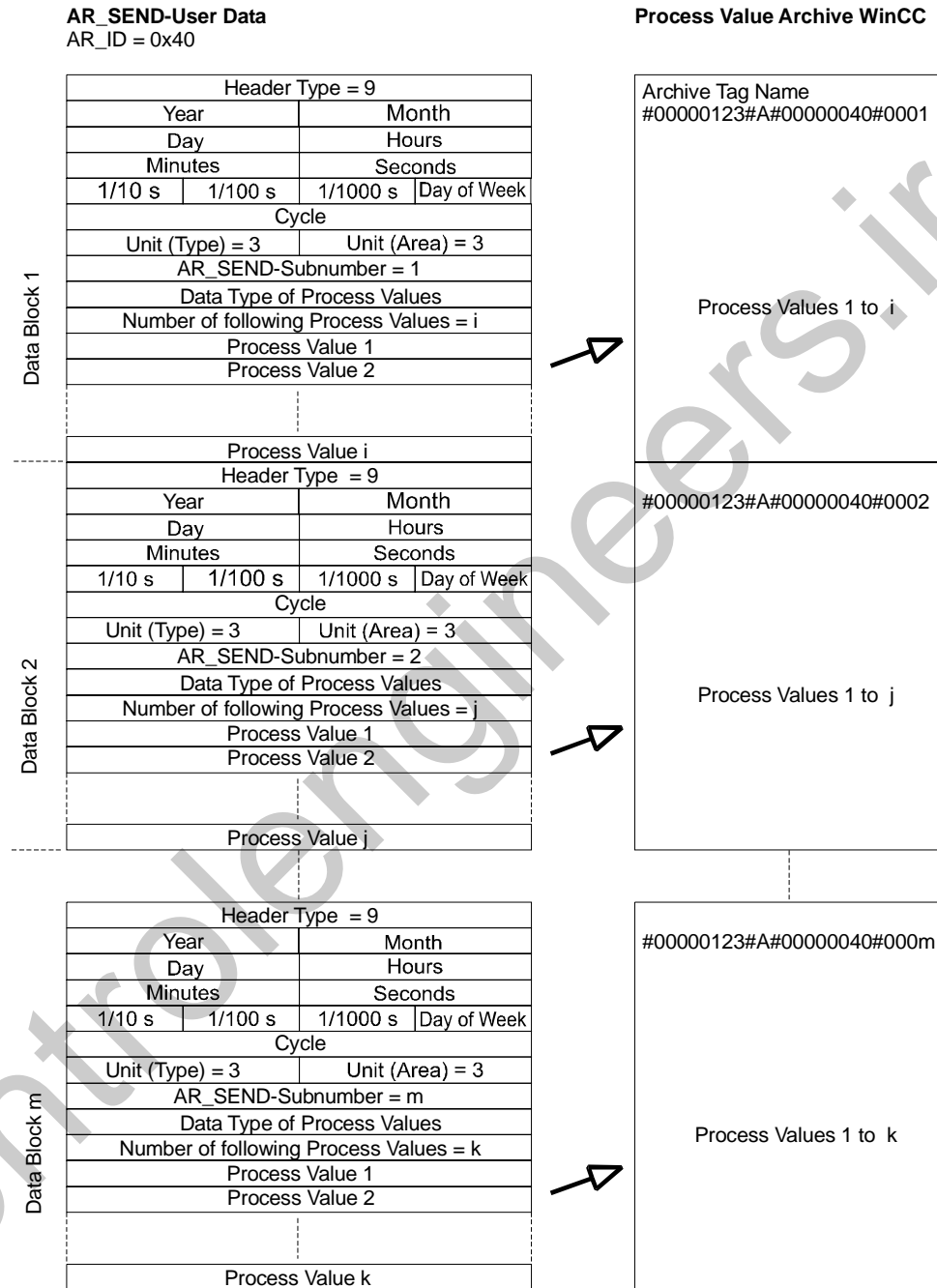
**Note**

The "AR\_SEND" subnumbers specified in the data blocks must all be configured in WinCC. WinCC stops the interpretation of the user data as soon as a non-configured "AR\_SEND" subnumber is recognized.

The data blocks must always start at word boundaries, i.e. for the BYTE data type and unit (type) = 1 (process values with equidistant time intervals), an even number of bytes must be specified.

#### 4.5.5.4 Data Exchange with "AR\_SEND" for multiple Archive Tags - Optimized

For applications in which, at one point in time, the current values of as many archive tags ("AR\_SEND" subnumber) as possible are to be supplied with a process value each, the following data block structure applies. In this case, the user data only consists of one data block, and each process value of the "AR\_SEND" subnumber and following value. In this data block, the data type and date/time stamp is the same for all process values of the archive tags.

- Header Type = 1; i.e. with time stamp and without "AR\_SEND" subnumber
- Unit (Type) = 4; i.e. process value contains "AR\_SEND" subnumber
- Unit (Area) = 0; i.e. time stamp in header applies to all process values, no relative times exist

Example of a Data Area Structure

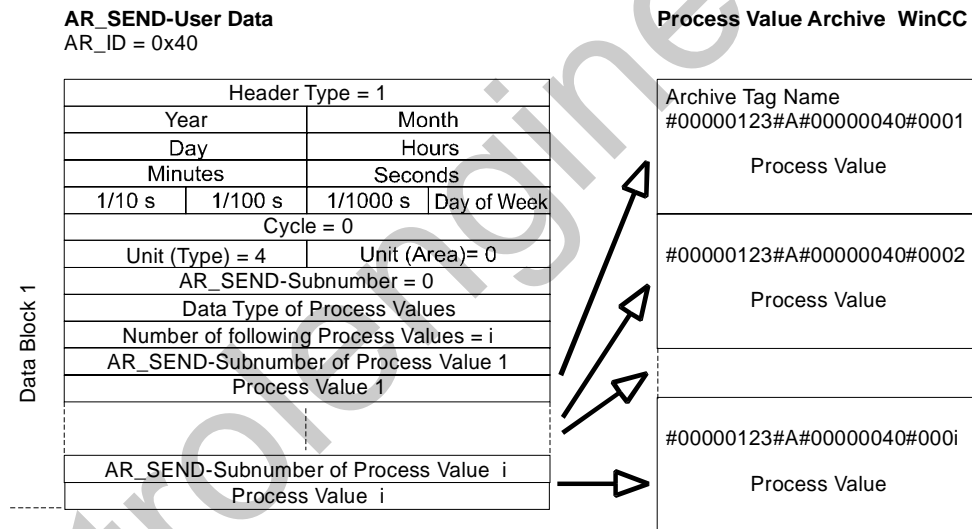

**Note**

If a process value contains an "AR\_SEND" subnumber for which no WinCC archive tag exists, a WinCC diagnosis log entry will be made. The remaining process values continue to be processed.

## 4.5.6 Connection Parameters

### 4.5.6.1 S7 MPI Channel Unit

The S7-300 and S7-400 PLCs either use their internal MPI interface or the CP 342-5 (SIMATIC S7-300)/CP 443-5 (SIMATIC S7-400) card.

If WinCC has been installed on a PG 760/PC RI45, the internal MPI interface can be used, otherwise an MPI card must be installed. As an alternative, the CP 5511 (PCMCIA card) can be used as well.

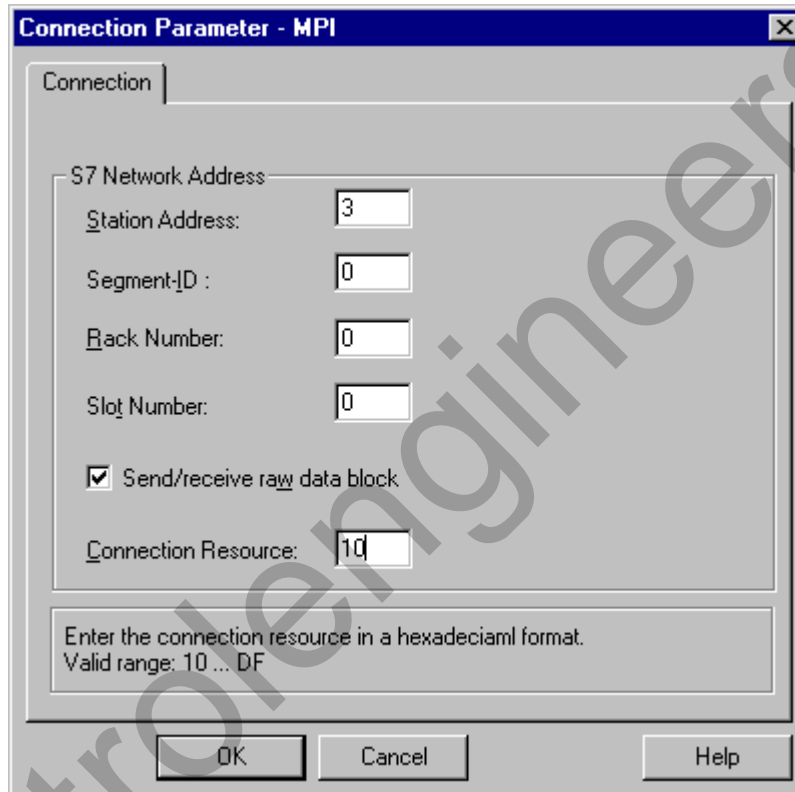

Field	Description
Station Address	Station address of the SIMATIC S7 on the bus. Value Range: 0 - 126
Segment ID	This field is currently not supported and must remain set at "0".
Rack Number	Rack number of the CPU to be addressed. Value Range: 0 - 7
Slot Number	Number of the CPU slot in the rack. Value Range: 0 - 18
Send/Receive Raw Data Block	Is activated, if BSEND/BRCV data blocks are to be transferred via the connection. Specify the correct slot number!
Connection Resource	This field becomes active, if the "Send/Receive Raw Data Block" check-box has been activated. Value Range (hex): 10 - DF

---

**Note**

If an S7-300 or 400 with an external communication processor is used, the rack/slot number of the CPU must be specified.

If an incorrect rack or slot number is specified, the communication-connection will not be established!

If an S7-300 is used, the rack/slot number = 0 must be specified for connections carried out via the internal MPI interface of the CPU.

---

**How to configure the Communication Parameters:**

1. Select the channel unit and open the "Channel Unit Properties" dialog box via the pop-up menu.
2. In the "Connections" tab, click on the "Properties" button to open the "Connection Properties" dialog box.
3. In the "General Information" tab, click on the "Properties" button.
4. Enter the station address of the SIMATIC S7 on the bus in the "Station Address" field.
5. The "Segment ID" field is currently not supported.  
The value must remain set at "0".
6. In the "Rack Number" field, enter the number of the rack in which the CPU to be addressed has been inserted.
7. In the "Slot Number" field, enter the slot number of the CPU.
8. If you have activated the "Send/Receive Raw Data Block" check-box, the connection resource (hexadecimal) and correct slot number must be specified in addition.

#### 4.5.6.2 SINEC PROFIBUS Channel Unit

The S7-300 PLC uses a CP 342-5 module. The S7-400 PLC uses a CP 443-5 module.

The WinCC system uses the CP 5412/A2 communication card.

A second CP 5412/A2 can be addressed via the PROFIBUS II channel. Each CP 5412 can support 59 connections to S7-300 and 16 connections to S7-400 PLCs.

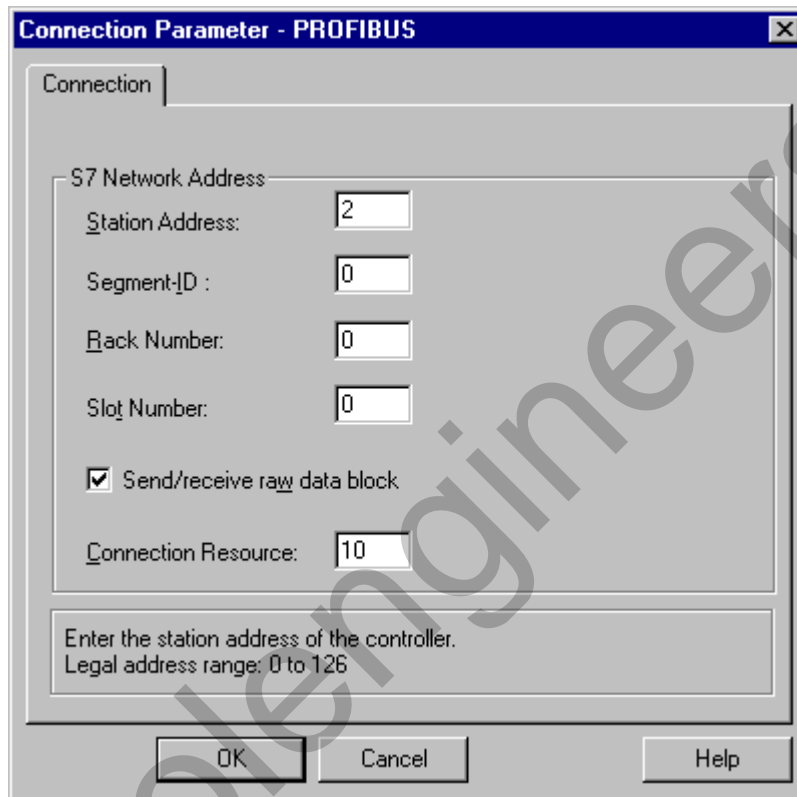

Field	Description
Station Address	Station address of the SIMATIC S7 on the bus. Value Range: 0 - 126
Segment ID	This field is currently not supported and must remain set at "0".
Rack Number	Rack number of the CPU to be addressed. Value Range: 0 - 7
Slot Number	Number of the CPU slot in the rack. Value Range: 0 - 18
Send/Receive Raw Data Block	Is activated, if BSEND/BRCV data blocks are to be transferred via the connection. Specify the correct slot number!
Connection Resource	This field becomes active, if the "Send/Receive Raw Data Block" check-box has been activated. Value Range (hex): 10 - DF

---

**Note**

If an S7-300 or 400 with an external communication processor is used, the rack/slot number of the CPU must be specified.

If an incorrect rack or slot number is specified, the communication-connection will not be established!

---

**How to configure the Communication Parameters:**

1. Select the channel unit and open the "Channel Unit Properties" dialog box via the pop-up menu.
2. In the "Connections" tab, click on the "Properties" button to open the "Connection Properties" dialog box.
3. In the "General Information" tab, click on the "Properties" button.
4. Enter the station address of the SIMATIC S7 on the bus in the "Station Address" field.
5. The "Segment ID" field is currently not supported.  
The value must remain set at "0".
6. In the "Rack Number" field, enter the number of the rack in which the CPU to be addressed has been inserted.
7. In the "Slot Number" field, enter the slot number of the CPU.
8. If you have activated the "Send/Receive Raw Data Block" check-box, the connection resource (hexadecimal) and correct slot number must be specified in addition.

### 4.5.6.3 SINEC Industrial Ethernet Channel Unit

The process connection via Industrial Ethernet is possible to the S7-300 PLC using the CP 343-1 card or to the S7-400 PLC using the CP 443-1 card, but not to the S7-200. Since the communication takes place via the ISO transport protocol, the SEND/RECEIVE interface of the CP 343-1/443-1 is used in the S7.

In the WinCC system, the CP 1413 communication card can support 30 connections. A second CP 1413 can be addressed via the "Industrial Ethernet (II)" channel, which allows a maximum of 60 connections.

Since the communication takes place via the ISO transport protocol, it is not necessary to configure the logical connection in the local database.

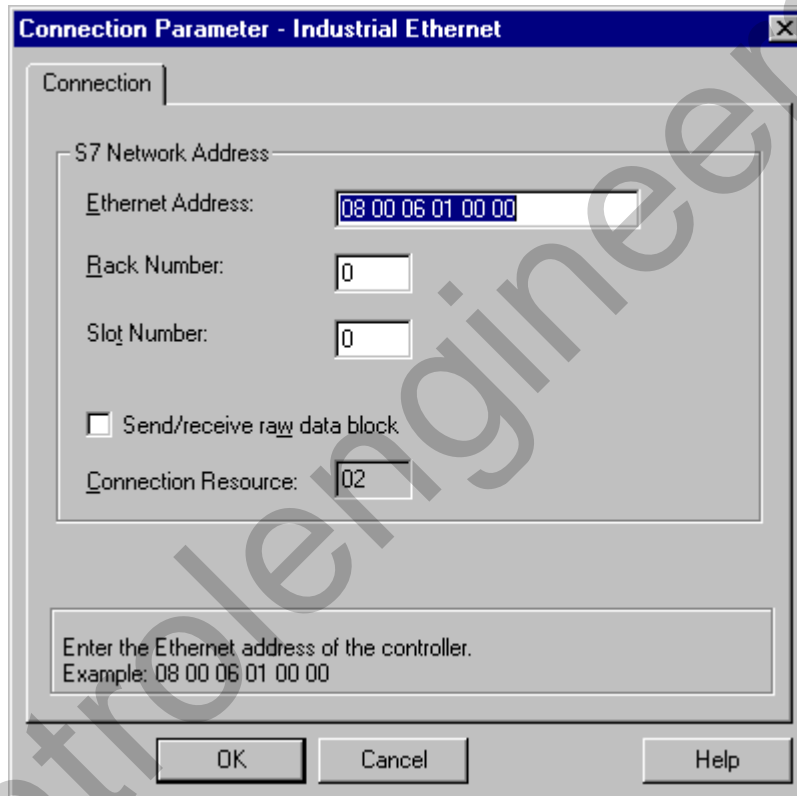
 The screenshot shows a dialog box titled 'Connection Parameter - Industrial Ethernet'. It has a 'Connection' tab selected. The 'S7 Network Address' section contains the following fields:
 

- Ethernet Address:** A text box containing the hexadecimal value '08 00 06 01 00 00'.
- Rack Number:** A spin box set to '0'.
- Slot Number:** A spin box set to '0'.
- Send/receive raw data block:** An unchecked checkbox.
- Connection Resource:** A spin box set to '02'.

 Below these fields is a text area with the instruction: 'Enter the Ethernet address of the controller. Example: 08 00 06 01 00 00'. At the bottom of the dialog are three buttons: 'OK', 'Cancel', and 'Help'.

Field	Description
Ethernet Address	Ethernet address of the SIMATIC S7 on the Industrial Ethernet bus.
Rack Number	Rack number of the CPU to be addressed. Value Range: 0 - 7
Slot Number	Number of the CPU slot in the rack. Value Range: 0 - 18
Send/Receive Raw Data Block	Is activated, if BSEND/BRCV data blocks are to be transferred via the connection. Specify the correct slot number!
Connection Resource	This field becomes active, if the "Send/Receive Raw Data Block" check-box has been activated. Value Range (hex): 10 - DF



---

**Note**

During the configuration of the CP 443-1, do not specify any jobs for the connection to the WinCC system.

If an S7-300 or 400 with an external communication processor is used, the rack/slot number of the CPU must be specified.

If an incorrect rack or slot number is specified, the communication-connection will not be established!

---

**How to configure the Communication Parameters:**

1. Select the channel unit and open the "Channel Unit Properties" dialog box via the pop-up menu.
2. In the "Connections" tab, click on the "Properties" button to open the "Connection Properties" dialog box.
3. In the "General Information" tab, click on the "Properties" button.
4. In the "Ethernet Address" field, enter the ethernet address of the SIMATIC S7 on the Industrial Ethernet bus.
5. The "Segment ID" field is currently not supported.  
The value must remain set at "0".
6. In the "Rack Number" field, enter the number of the rack in which the CPU to be addressed has been inserted.
7. In the "Slot Number" field, enter the slot number of the CPU.
8. If you have activated the "Send/Receive Raw Data Block" check-box, the connection resource (hexadecimal) and correct slot number must be specified in addition.

#### 4.5.6.4 Named Connections Channel Unit

This channel unit is used to set up a symbolic connection that has been configured in Step7. These symbolic connections, for example, are required for a highly available communication to the S7-400 PLC in conjunction with the redundancy in H/F systems. This allows WinCC to address redundant and non-redundant connections via a symbolic connection.

On the S7 side, the symbolic connection names are configured via the NETPRO application. This application also stores the connection names, connection parameters and application names in a database (\*.XDB). The database is placed automatically in the corresponding WinCC project folder by the AS/OS Engineering Tool "Mapper", but it can also be placed outside of this folder (if the "Mapper" is not used).

Only one XDB file can be valid for a WinCC computer.

To activate the database in WinCC, follow one of these steps:

- If the XDB file is located outside of the project folder (because the "Mapper" has not been used), the path and name of the XDB file must be specified in the "Step7 Configuration" tab of the "Setting the PG/PC Interface" application (Control Panel) before WinCC is started.  
After the start of WinCC, the XDB file from the project-external folder is used, provided that no other database exists within the project folder. This behavior is advantageous, if multiple projects access the same, centrally located database.
- If the "Mapper" has been used, the XDB file is automatically copied into the WinCC project folder by it. After starting WinCC and opening the project, the data is read by the S7 channel and entered into the Windows registry database.

Afterwards, the connection can be configured in WinCC: In the "Connection Parameter - Named Connections" dialog box, one of the symbolic connection names from the "Connection Name" drop-down list is assigned to a selected application name.

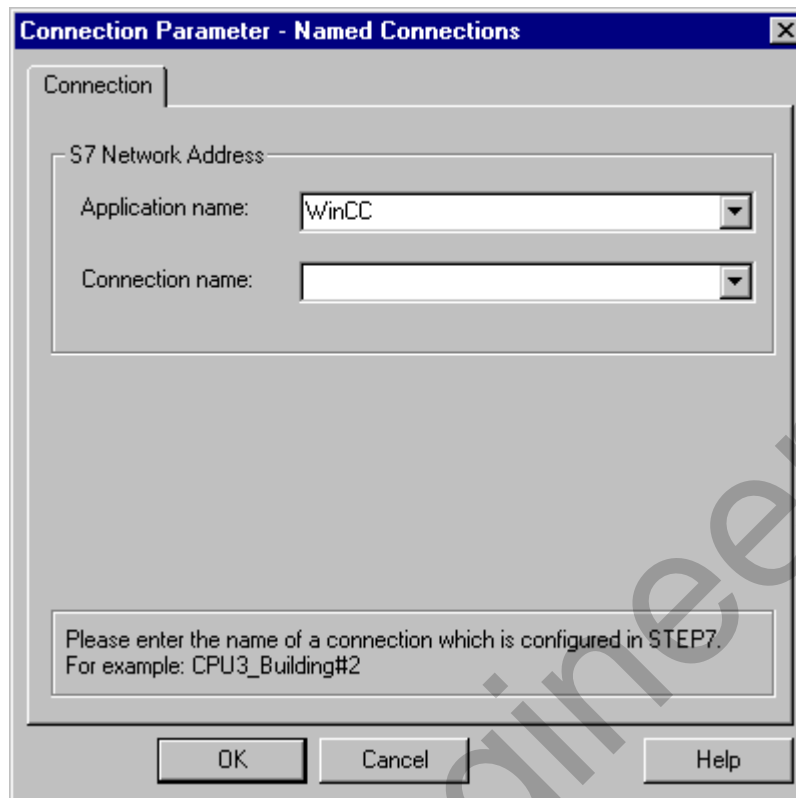

Field	Description
Application Name	Entry field for the application name that has been configured in Step7. Preset: "WinCC"
Connection Name	Entry field for the connection name that has been configured in Step7.

**Note**

To allow a transfer of the project to another computer, the application and connection names can also be entered by hand, instead of selecting them from the list. Ensure the correct spelling of the name (as configured on the S7), since no check of the name is performed in CS mode.

#### 4.5.6.5 SINEC Slot PLC Channel Unit

A process driver connection via the SINEC Slot PLC channel unit serves for communication with the built-in PLC card.

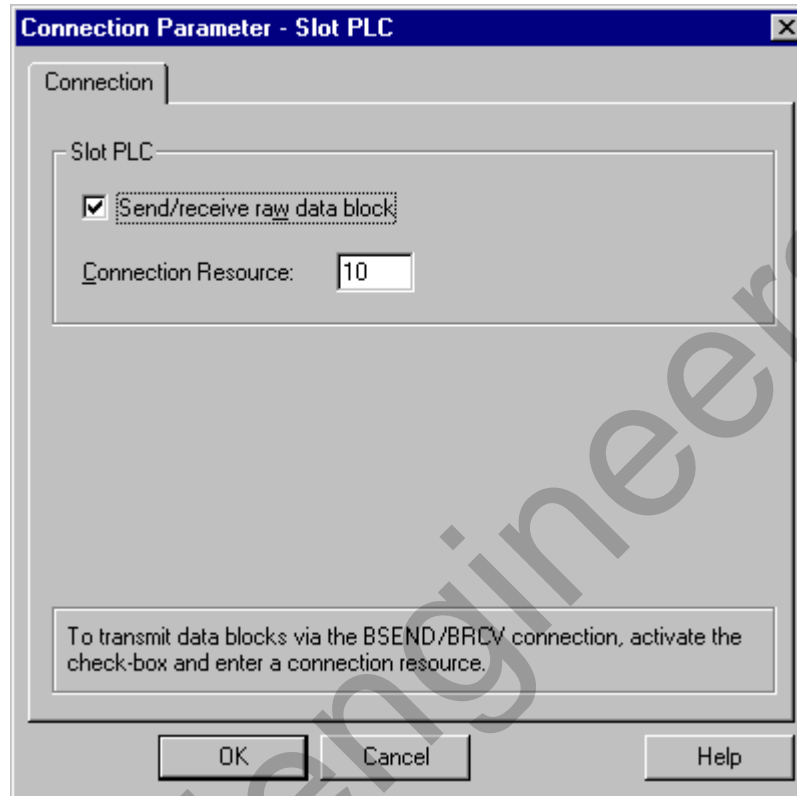

Field	Description
Send/Receive Raw Data Block	Is activated, if BSEND/BRCV data blocks are to be transferred via the connection. Specify the correct slot number!
Connection Resource	This field becomes active, if the "Send/Receive Raw Data Block" check-box has been activated. Value Range (hex): 10 - DF

#### How to configure the Communication Parameters:

1. Select the channel unit and open the "Channel Unit Properties" dialog box via the pop-up menu.
2. In the "Connections" tab, click on the "Properties" button if a connection is displayed in the table, otherwise click on "New". The "Connection Properties" dialog box will be displayed.
3. In the "General Information" tab, click on the "Properties" button.
4. If you have activated the "Send/Receive Raw Data Block" check-box, the connection resource (hexadecimal) must be specified in addition.

#### 4.5.6.6 SINEC-TCP/IP Channel Unit

The process connection via the SINEC-TCP/IP channel unit supports the communication via networks using the TCP/IP protocol.

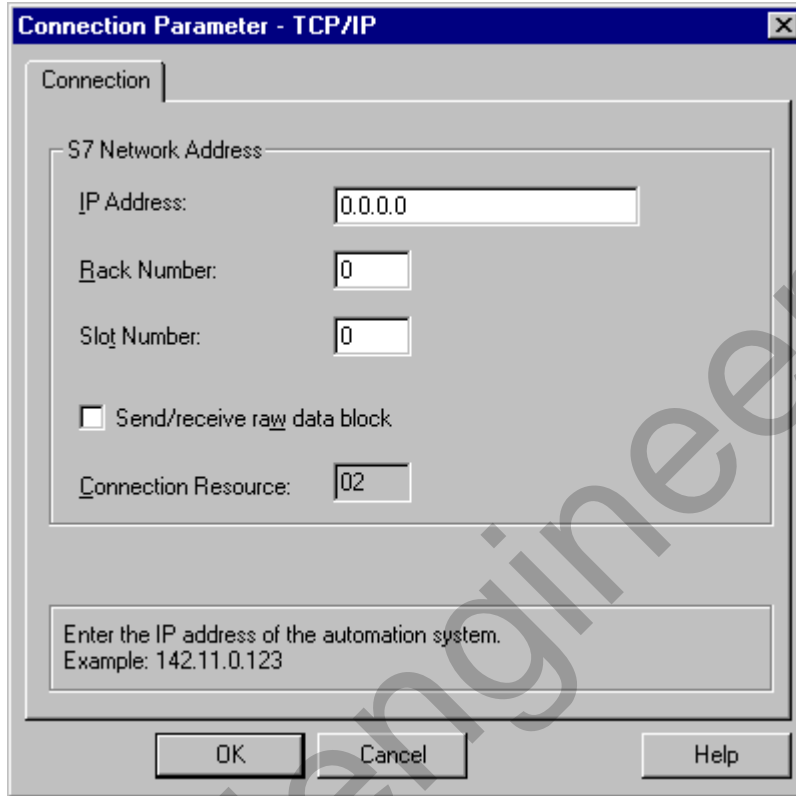

Field	Description
IP Address	Internet protocol address of the SIMATIC S7 on the TCP/IP bus.
Rack Number	Rack number of the CPU to be addressed. Value Range: 0 - 7
Slot Number	Number of the CPU slot in the rack. Value Range: 0 - 18
Send/Receive Raw Data Block	Is activated, if BSEND/BRCV data blocks are to be transferred via the connection. Specify the correct slot number!
Connection Resource	This field becomes active, if the "Send/Receive Raw Data Block" check-box has been activated. Value Range (hex): 10 - DF

#### Note

If an S7-300 or 400 with an external communication processor is used, the rack/slot number of the CPU must be specified.

If an incorrect rack or slot number is specified, the communication-connection will not be established!

### How to configure the Communication Parameters:

1. Select the channel unit and open the "Channel Unit Properties" dialog box via the pop-up menu.
2. In the "Connections" tab, click on the "Properties" button if a connection is displayed in the table, otherwise click on "New". The "Connection Properties" dialog box will be displayed.
3. In the "General Information" tab, click on the "Properties" button.
4. In the "IP Address" field, enter the Internet protocol address of the SIMATIC S7 on the TCP/IP bus.
5. In the "Rack Number" field, enter the number of the rack in which the CPU to be addressed has been inserted.
6. In the "Slot Number" field, enter the slot number of the CPU.
7. If you have activated the "Send/Receive Raw Data Block" check-box, the connection resource (hexadecimal) and correct slot number must be specified in addition.

## 4.5.7 Software Redundancy

Within WinCC, the software redundancy feature makes it possible to monitor critical sections of a plant by using a redundant connection to several PLCs.

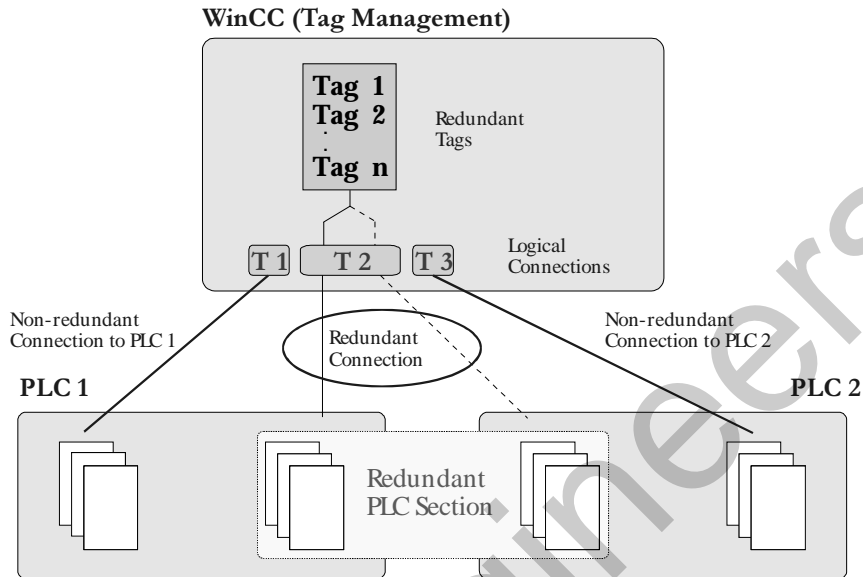

Software redundancy considerably improves reliability when critical plant sections are to be monitored. For example, a redundant connection to two PLCs means that one PLC takes over if the other PLC fails. Using software redundancy does not mean that you can only establish redundant connections to the PLCs configured. It is still possible to connect any PLC in a non-redundant layout. The switchover between redundant PLCs is performed automatically in the event of a malfunction. However, a manual switchover is also possible by specifying a tag (@ForceConnectionState).

---

### Note

Establishing a redundant connection requires two PLCs.

---

### Setting up software redundancy:

In order to use software redundancy under WinCC, the following settings are required in the WinCC Explorer:

1. The computer properties must be set to the following values:

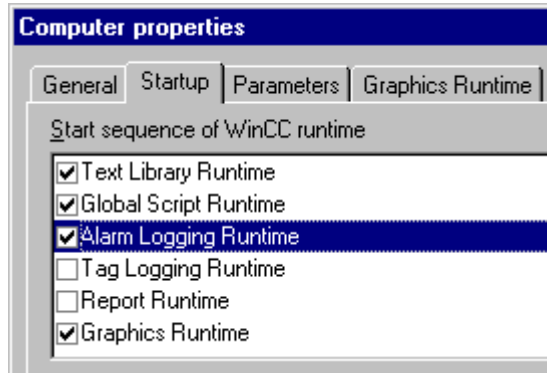

2. Within the Alarm Logging system, the "short-term archive" must be activated:

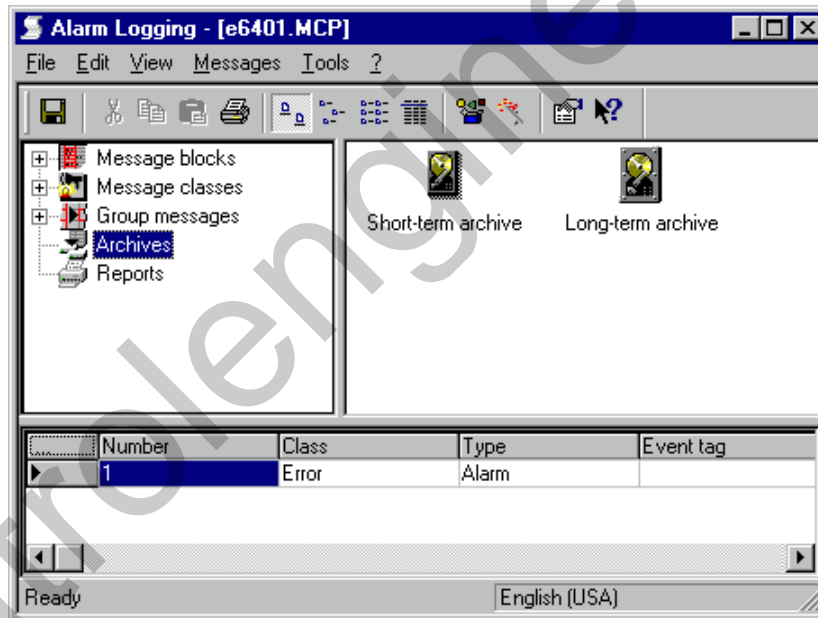





3. Within the Alarm Logging, the system messages must be retrieved; select the "Options" and "WinCC System Messages" menu items for this purpose. In the "WinCC system messages" dialog box, activate the "Create New System Messages Only" option and press the "Create" button. This procedure retrieves the system messages associated with software redundancy.

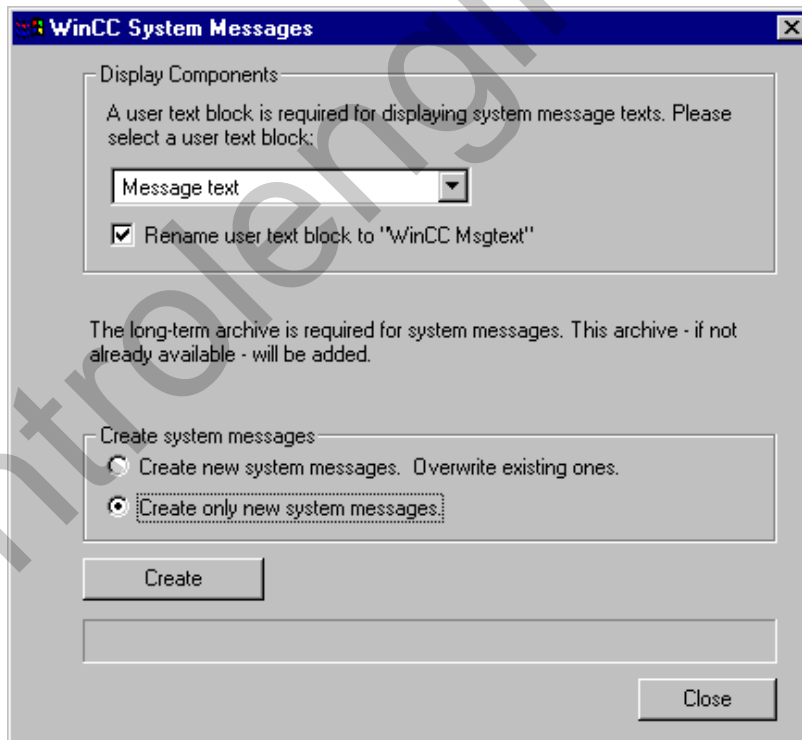

4. By means of the "DynWizEdit.exe" program, integrate the Dynamic Wizard for software redundancy into the WinCC system (Graphics Designer). This integration procedure requires the following steps: In the Windows Explorer, start the "C:\Siemens\WinCC\bin\DynWizEdit.exe" program. Select the "German" language in the toolbar. Retrieve the "C:\Siemens\WinCC\wscripts\wscripts.enu\Software\_Redundancy.wnf" script by selecting the "Dynamic Wizard" and "Retrieve Wizard Script" menu items. The compilation progress is shown in the output window. After the compilation has been completed successfully, the new entry "Establish Redundant Connection" appears in the "Dynamic Wizard" window.

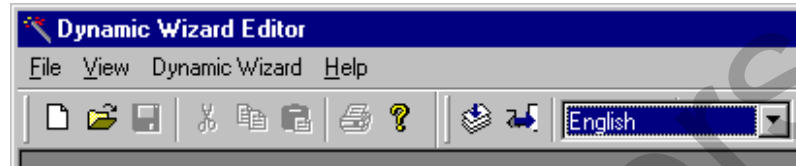

5. Integrate the "SIMATIC S7 PROTOCOL SUITE" communications driver within the tag management.
6. Within the required bus type (e.g. MPI), create a logical connection in the "SIMATIC S7 PROTOCOL SUITE" communications driver. Give an expressive name to this connection.
7. Open an existing picture in the Graphics Designer. Within the Dynamic-Wizard (in the "System Functions" tab), start the "Establish Redundant Connection" program by double-clicking.

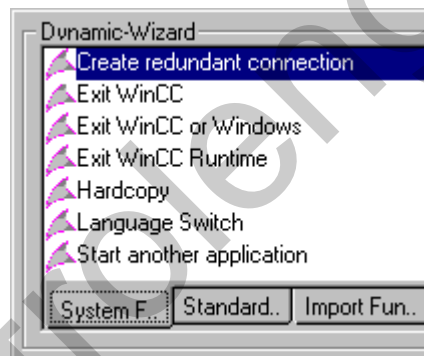

8. Press the "Continue" button in the welcome screen.

9. Select the main connection in the "Set Options" dialog box. Then press the "Continue" button.

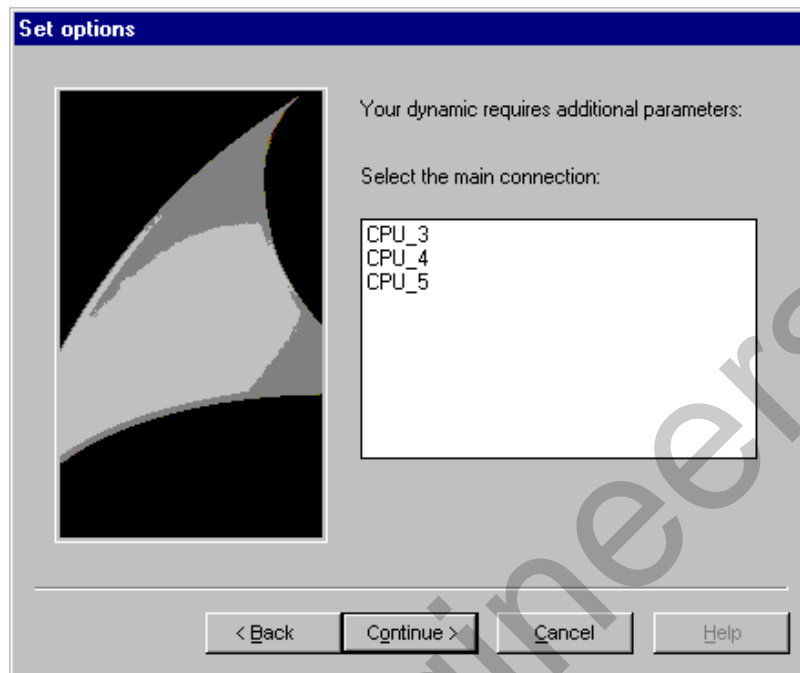

10. Edit the settings for the back-up connection in the "Set Options" dialog box. Then press the "Continue" button. The "Automatic Switchover" check box must be active (default setting).

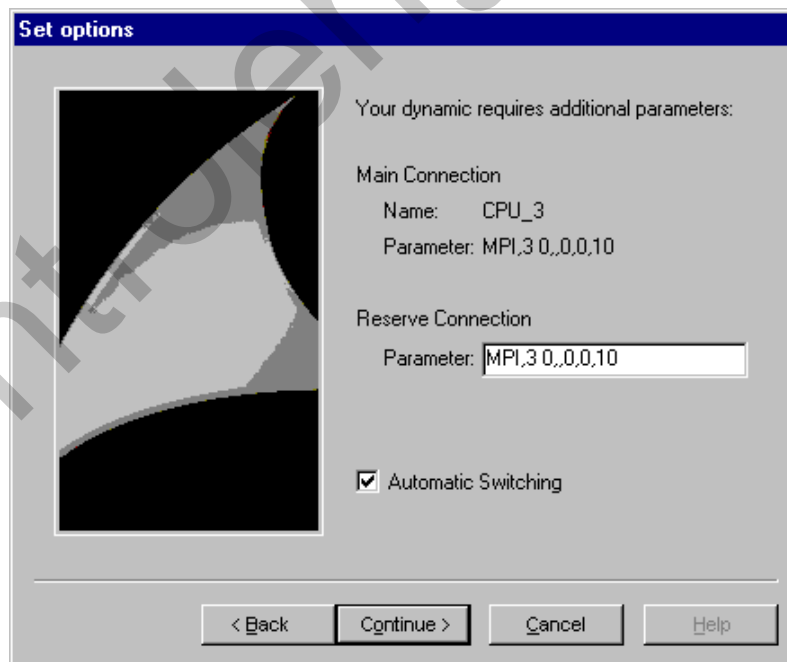

The settings for the back-up connection (S7 network address) can be found in the "Connection" tab. Access this tab via the connection properties dialog box for the connection.

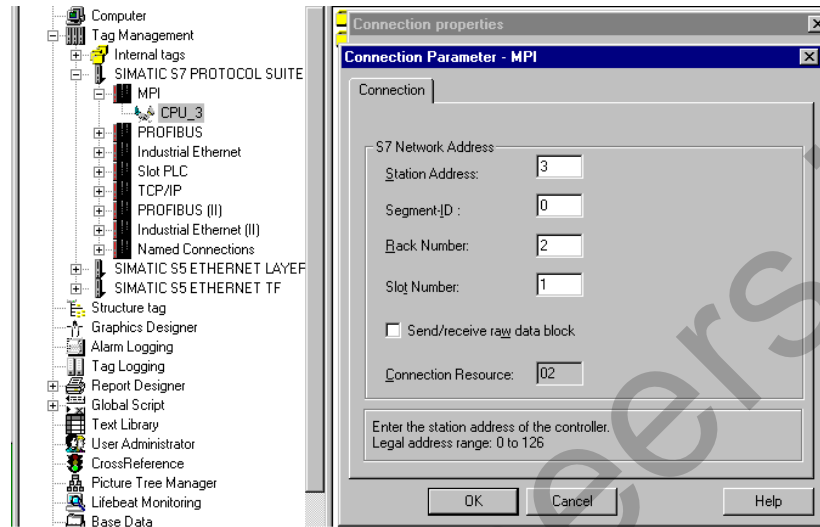

- The settings you specified are displayed in the final "Finished" dialog box. By pressing the "Finish" button, connection-specific internal tags are created in a tag group. This tag group is stored within the tag management under "SIMATIC S7 PROTOCOL SUITE" and the associated channel unit.

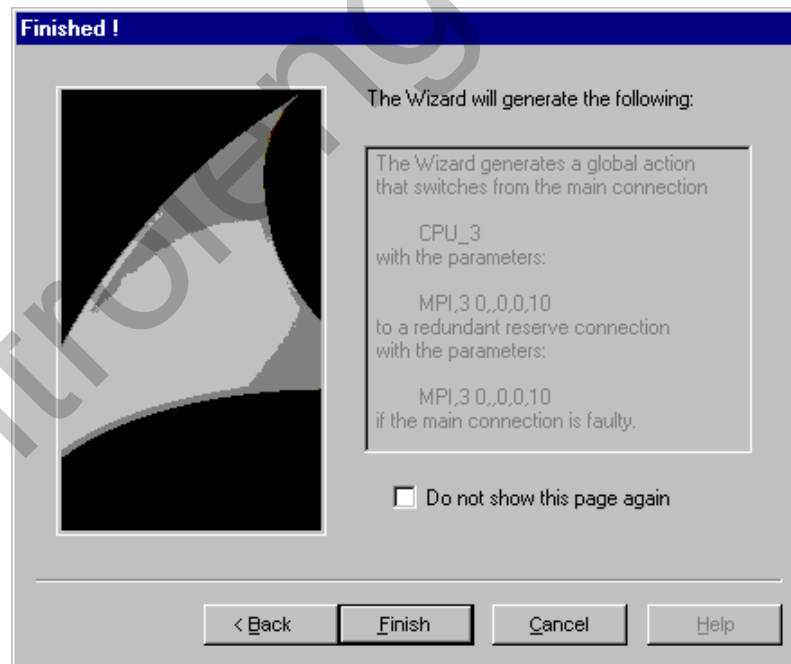

#### Note

By pressing the "Back" button, you can go back one step and make any necessary changes.

#### 4.5.7.1 Connection-specific Internal Tags

Connection control is accomplished by means of connection-specific internal tags. The connection-specific internal tags are created by a wizard. The name of a connection-specific internal tag is composed of the name of the associated connection and an identifier. The connection name is provided with a '@' prefix to identify it as a system tag. Example: "@connection name@identifier". All connection-specific internal tags are assembled to form a "@connection name" tag group.

##### Note

Only if the associated connection is ready for operation does the WinCC data manager permit access to connection-specific tags. However, it is possible to have read and write access to connection-specific internal tags independently of the connection status.

The following system tags are available for SIMATIC S7 Protocol Suite software redundancy:

@ConnectionState	
<i>Meaning:</i>	connection status
<i>Type:</i>	DWORD
<i>Access:</i>	read
<i>Default:</i>	0 = "faulty"
<p>The current connection status can be determined by means of the 'ConnectionState' tag.</p> <p>0 = connection faulty            1 = connection ready for operation            2 = connection redundant (only with redundancy in H-systems)</p>	

@ConnectionError	
<i>Meaning:</i>	error cause
<i>Type:</i>	DWORD
<i>Access:</i>	read
<i>Default:</i>	0 = "no error"
<p>The tag contains an error cause describing the reason why the connection was interrupted. Default = 0, i.e. connection not yet established or without error. When establishing a connection, the tag is loaded with 0 (no error) again. The error code is interpreted in a channel-specific manner. The S7 channel stores the S7 DOS error code here.</p> <p>0 = no error            &lt;&gt; 0 = S7 DOS error code</p>	

**@ConnectionErrorString**

*Meaning:* error cause as string  
*Type:* TEXT8 [128]  
*Access:* read  
*Default:* "" = "no error"

The tag contains the error cause in the format of a string describing the reason why the connection was interrupted. The string is put out in the language currently selected. Default = "", i.e. connection not yet established or without error. The following texts are entered in the S7 channel in English, without regard to the selected language.

"No Error" = No error  
 "Error hhhh" = hhhh error occurred  
 (hhhh = S7 DOS hexadecimal error code)

**@ConnectionErrorCount**

*Meaning:* communication error counter  
*Type:* DWORD  
*Access:* read  
*Default:* 0 = "no error"

The value of this tag is incremented by 1 each time a connection is interrupted.

In the event of an overflow the count starts again with 0.

**@ConnectionEstablishMode**

*Meaning:* connect mode  
*Type:* DWORD  
*Access:* write  
*Default:* 1 = "automatic"

This tag enables you to specify a connection to be established automatically. The S7 channel then attempts to reestablish a failed connection at intervals of approx. 4 seconds. If a value = 0 is entered in this tag, the connection will not be reestablished automatically at intervals of 4 seconds, but remains interrupted.

Writing the @ConnectionEstablishMode tag takes the following effect:

0 = manual connecting mode  
 -> deactivate automatic connecting  
 <> 0 = automatic connect mode  
 -> activate automatic connecting

**@ForceConnectionState**

*Meaning:* preferred connection status

*Type:* DOWRD

*Access:* write

*Default:* 1 = "established"

This tag can be used to notify the channel of the preferred connection status. Usually this tag has the value 1, i.e. the channel attempts to establish the connection (at regular intervals of approx. 4 seconds, if applicable). If the value 0 is written to this tag, the channel interrupts the connection.

Writing to this tag takes the following effect:

0 = preferred connection status: connection interrupted  
 -> if connection established  
 -> cause connection to be interrupted  
 1 = preferred connection status: connection established  
 -> if connection interrupted  
 -> cause connection to be established

**@ForceConnectionAddress**

*Meaning:* selecting the connection address

*Type:* DWORD

*Access:* write

*Default:* 0 = "configured"

This tag specifies which of the connection addresses is to be used for establishing the connection.

Writing to this tag takes the following effect:

0 = connection via configured connection parameters  
 -> if @ForceConnectionAddress previously 1  
 -> cause connection to be interrupted  
 1 = connection via alternative connection parameters  
 -> if @ForceConnectionAddress previously 0  
 -> cause connection to be interrupted  
 -> If connect mode is set to "automatic", the connection is automatically established with the corresponding address.

#### @AlternateConnectionAddress

*Meaning:* Alternative connection address  
*Type:* TEXT8 [255]  
*Access:* write  
*Default:* "... " = "configured"

The alternative connection address string can be entered in this tag. This is the same string as the one which is displayed as connection parameter in the WinCC Explorer. The string is channel-specific. On system start-up (runtime), the configured address is entered here as default for the S7 channel. If an address has not been configured yet, the text "Illegal Address" is entered for the S7 channel.

Example of an address specified for an S7 PLC with station address 3 via MPI:  
 "MPI,3 0,,0,0,02"

Writing to this tag takes the following effect:

- > If the address is changed by the write process, the "Connection via alternative connection parameters" setting causes the connection to be interrupted.
- > If the "automatic" connect mode has been set, the connection is established automatically, using the address just previously written.



## 4.6 SIMATIC TI505 Serial Communication Driver

This communication driver is used for the serial connection to the SIMATIC TI505 PLC.

### Channel Units

This communication driver has a channel unit that makes it possible to operate a COM port for serial connection.

The following application is available:

- Channel Unit SIMATIC TI505 Unit #1 for serial communication by means of either the TBP protocol or the NITP protocol.

---

### Note

It is possible to use one channel unit to operate more than one logical connection (by means of different COM ports).

---

### 4.6.1 Data Type of Tags

You define the tags necessary for a logical connection. WinCC enables you to access the following data types:

- Binary tag
- Unsigned 8-bit value (supported only by VMS addressing)
- Signed 8-bit value (supported only by VMS addressing)
- Unsigned 16-bit value
- Signed 16-bit value
- Unsigned 32-bit value
- Signed 32-bit value
- 32-bit IEEE 754 floating-point number

## 4.6.2 Address of Tags

You enter the tag address according to the address structure of SIMATIC TI505.

### How to Enter the Tag Address:

1. Select the tag and use the pop-up menu to open the "Properties" dialog box.
2. In the "General Information" tab, select the desired data type (for example, signed 16-bit value).
3. Click on the "Select" button. The "Address Properties" dialog window opens.

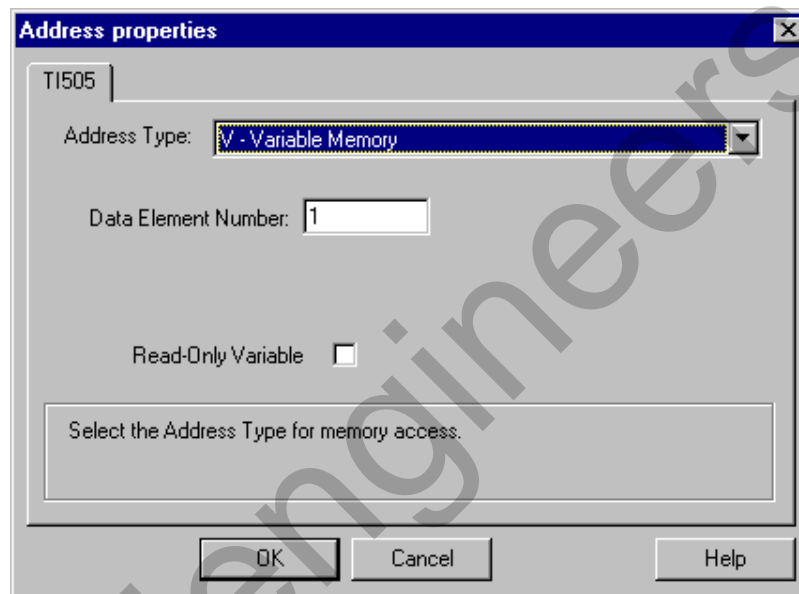

4. In the "Address Type" box, select the location of the tag in the PLC. Depending on the address type that you select, you must supply additional information (for example, in the "Data Element" box for the "V - Variable Memory" address type).
5. If you select the "Read-Only Tag" check box, you can specify that the WinCC system cannot write to the tag.

---

### Note

For a description of the address types, consult the technical documentation for SIMATIC TI505.

---

### 4.6.3 Connection Parameters

The process driver connection by means of serial connection is possible with the SIMATIC TI505 PLC. In this PLC, the serial interface on the CPU module is used.

No additional communication module is needed in the WinCC system. Communication can take place by means of one of the standard COM ports available in the system.

#### How to Configure the Communication Parameters:

1. Select the connection and use the pop-up menu to open the "Properties" dialog box.
2. Select the "Communications" tab.

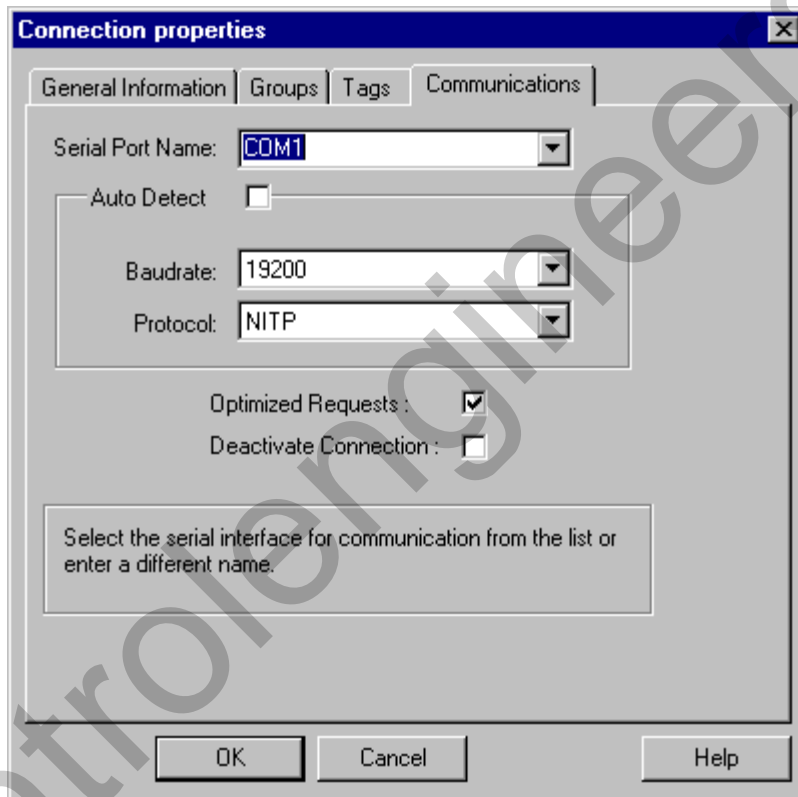

3. In the "Serial Port Name" box, select the communication interface (for example, COM1, COM2, or a configured port) for the serial connection.
4. Select the "Detect Automatically" box if the channel unit should detect automatically the data transmission speed and the protocol used by the controller.

or

In the boxes "Baud Rate" and "Protocol," set the data transmission speed and protocol used.

5. By selecting the "Optimized Requests" check box, you can optimize the data transmission to be able to transmit several tags with one request.
6. If you select the "Deactivate Connection" box, the logical connection is deactivated. For example, this is a good idea during system startup if you want to interrupt a connection temporarily.

## 4.7 SIMATIC TI505 Ethernet Layer 4 Communication Driver

This communication driver is used for the connection to such PLCs as the SIMATIC TI505 by means of the ISO transport protocol.

### Channel Units

This channel DLL has two channel units that make it possible to operate a maximum of two CP 1413's. The functionality of the channel units is identical. They differ only in their logical device names.

You can change the logical device name by means of the system parameters of the channel unit. You can also set the parameters for the ISO transport protocol here.

The following applications are possible:

- Channel Unit TI505 Ethernet (CP 1413-1) for the communication modules for SIMATIC Industrial Ethernet (for example, CP 1413).
- Channel Unit TI505 Ethernet (CP 1413-2) for the communication modules for SIMATIC Industrial Ethernet (for example, CP 1413).

### 4.7.1 Data Type of Tags

You define the tags necessary for a logical connection. WinCC enables you to access the following data types:

- Binary tag
- Unsigned 8-bit value (supported only by VMS addressing)
- Signed 8-bit value (supported only by VMS addressing)
- Unsigned 16-bit value
- Signed 16-bit value
- Unsigned 32-bit value
- Signed 32-bit value
- 32-bit IEEE 754 floating-point number

## 4.7.2 Address of Tags

You enter the tag address according to the address structure of SIMATIC TI505.

### How to Enter the Tag Address:

1. Select the tag and use the pop-up menu to open the "Properties" dialog box.
2. In the "General Information" tab, select the desired data type (for example, signed 16-bit value).
3. Click on the "Select" button. The "Address Properties" dialog window opens.
4. Select the "TI505" tab.

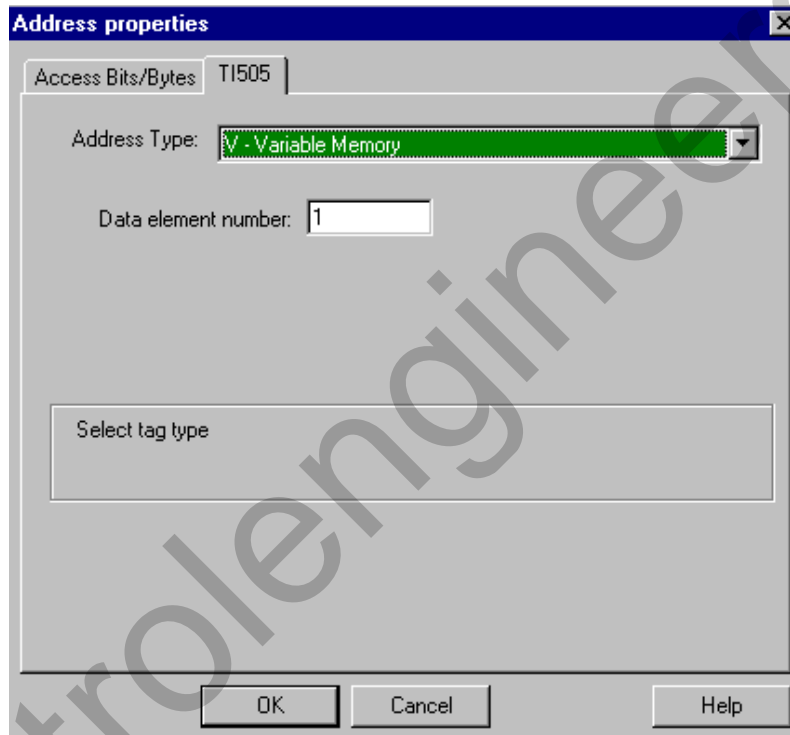

5. In the "Address Type" box, select the location of the tag in the PLC. Depending on the address type that you select, you must supply additional information (for example, in the "Data Element" box for the "V - Variable Memory" address type).
6. If you select the "Read-Only Tag" check box, you can specify that the WinCC system cannot write to the tag.

---

### Note

For a description of the address types, consult the technical documentation for SIMATIC TI505.

---

Access to the memory locations of a PLC can often take place only by byte or word. If binary or 8-Bit tags are used, the “Address Properties” dialog will contain an additional tab, through which individual bits, in the PLC’s memory locations, can be changed. For that reason, every write instruction reads the addressed memory location from the PLC and changes the corresponding bits/bytes. Afterwards, the data is written back into the PLC.

---

#### Note

Changes to the read data, made by the PLC, will be overwritten during the write back.

Depending on the tag type, access, to the memory locations of a PLC, is carried out either by bit or by byte.

---

#### Setting the by Bit Access:

1. Right mouse button click on the desired tag to open its pop-up menu, and select “Properties”.
2. Open the “General Information” tab and select the “Binary Tag” data type.
3. Click on the “Select” button to open the “Address Properties” dialog.

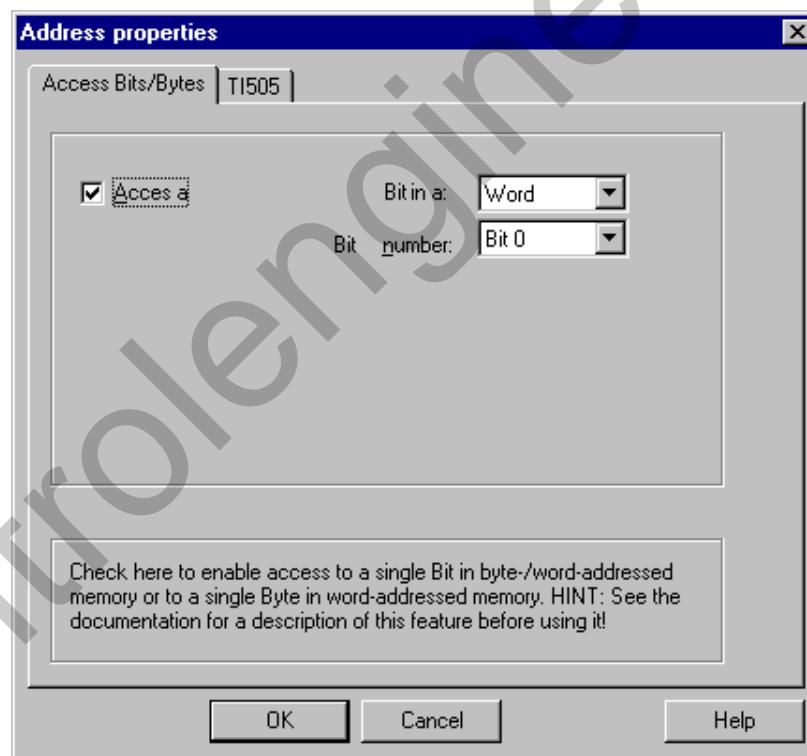

4. Via the checkbox, the “By Bit” accessing method can be selected.
5. Select the addressing method of the PLC memory locations from the list box.
6. Select the number of the bit to be changed from the list box.

---

#### Note

In the S5 PLC, markers, inputs, and outputs can be addressed by byte, and data blocks (DB, DX) can be addressed by word.

---

### Setting the by Byte Access

1. Right mouse button click on the desired tag to open its pop-up menu, and select “Properties”.
2. Open the “General Information” tab and select the “Unsigned 8-Bit Value” or “Signed 8-Bit Value” data type.
3. Click on the “Select” button to open the “Address Properties” dialog.

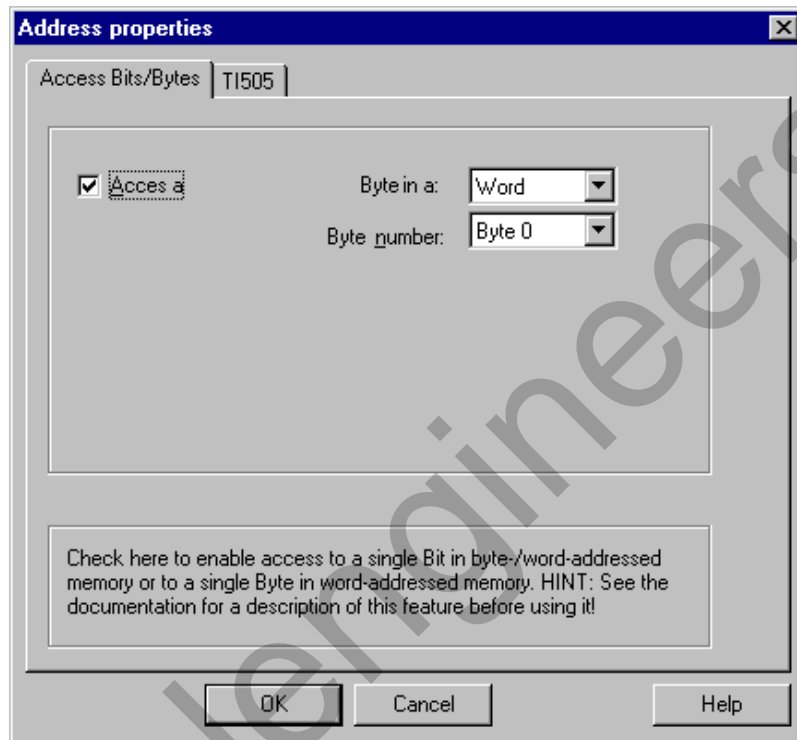

4. Via the checkbox, the “By Byte” accessing method can be selected.
5. Select the addressing method of the PLC memory locations from the list box.
6. Select the number of the bit to be changed from the list box.

### 4.7.3 System Parameters

The process driver connection by means of Industrial Ethernet is possible with the SIMATIC TI505 PLCs. These PLCs use the CP 1434 TF communication module. Communication takes place by means of the ISO transport protocol.

The WinCC system uses the CP 1413 communication module. Because communication takes place by means of the ISO transport protocol, it is not necessary to configure the logical connection in the local database.

#### How to Configure the System Parameters:

1. Select the channel unit and use the pop-up menu to open the "System Parameters" dialog box.
2. Select the "Device Names" tab.

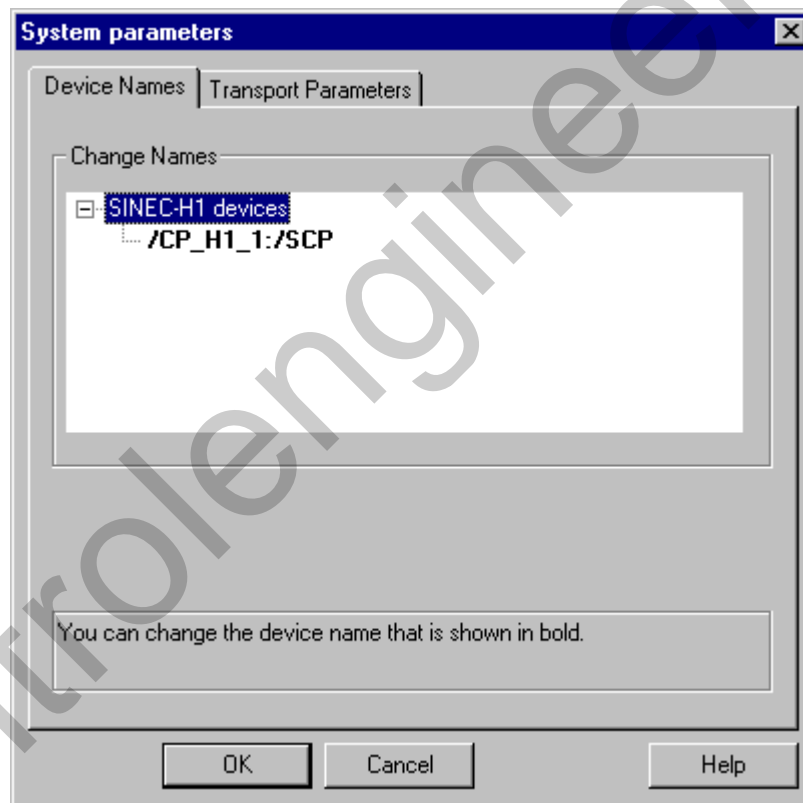

3. Select the device name displayed in bold type and click in the name box to change the device name.

---

#### Note

The device name is specified when the hardware driver is installed. Only if you assigned a different name then (which, however, is not a good idea) do you have to change the device name here also.

---



4. Select the "Transport Parameters" tab.

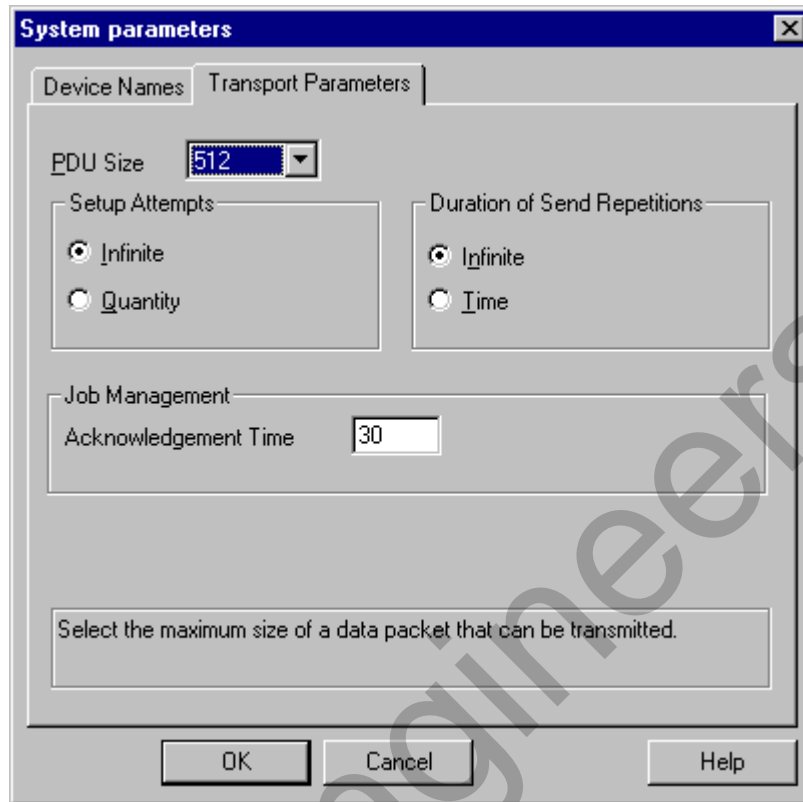

5. Set the value in the "PDU Size" box to the value that was also configured on the CP 1434 TF.
6. In the "Setup Attempts" box, specify how often an attempt should be made to set up a connection.
7. In the "Duration of Send Repetitions" area, select "Infinite."
8. In the "Acknowledgment Time" box, enter the value 30 so that you are informed after no more than 30 seconds by means of the tag status that the remote PLC did not answer within this time (for example, PLC is in the STOP mode).

#### 4.7.4 Connection Parameters

For a logical connection, WinCC sets up one connection each for reading (READ) and writing (WRITE) in the transport layer. The logical connection is not designated as set up until both of these connections have been established.

##### How to Configure the Communication Parameters:

1. Select the connection and use the pop-up menu to open the "Properties" dialog box.
2. Select the "Connection" tab.

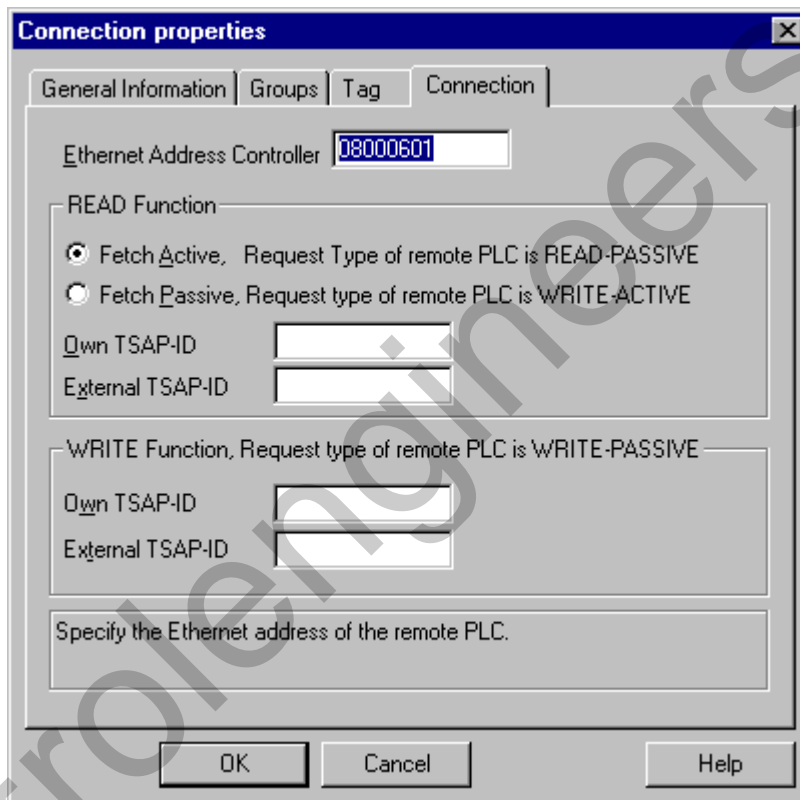
 The screenshot shows the 'Connection properties' dialog box with the 'Connection' tab selected. The 'Ethernet Address Controller' field contains the value '08000601'. Under the 'READ Function' section, the 'Fetch Active' radio button is selected. Below this are fields for 'Own TSAP-ID' and 'External TSAP-ID'. A similar section exists for the 'WRITE Function'. At the bottom, there is a text box labeled 'Specify the Ethernet address of the remote PLC.' and buttons for 'OK', 'Cancel', and 'Help'.

3. In the "Ethernet Address Controller" box, enter the station address of the SIMATIC TI505 on the Industrial Ethernet bus.
4. Specify the parameters for the READ function in the WinCC system. They depend on the request used in the SIMATIC TI505.

WinCC Side	SIMATIC TI505 Side
FETCH Active (Request "READ Active")	READ Passive (Request "READ Passive")
FETCH Passive (Request "WRITE Passive")	WRITE Active (Request "WRITE Active")

5. In the "Own TSAP-ID" box, enter the value that was configured for the CP 1434 TF as "TSAP" under the heading of "Remote Parameters."
6. In the "External TSAP-ID" box, enter the value that was configured for the CP 1434 TF as "TSAP" under the heading of "Local Parameters."
7. Enter the appropriate parameters for "Own TSAP-ID" and "External TSAP-ID" for the WRITE function.

WinCC Side	SIMATIC TI505 Side
Request "WRITE Active"	Request "WRITE Passive"

## 4.8 Windows DDE Communication Driver

This communication driver is used for connecting to applications by means of the DDE interface (Dynamic Data Exchange).

### Channel Unit

This communication channel has a channel unit that makes it possible to operate the interface.

The following application is available:

- Channel unit DDE for communication by means of the DDE interface of Windows.

### 4.8.1 Data Type of Tags

You define the tags necessary for a logical connection. WinCC enables you to access the following data types:

- Binary tag
- Unsigned 8-bit value
- Signed 8-bit value
- Unsigned 16-bit value
- Signed 16-bit value
- Unsigned 32-bit value
- Signed 32-bit value
- Text tag 8-bit character set
- Raw data type

## 4.8.2 Address of Tags

You enter the tag address according to the address structure of the DDE server application.

### How to Enter the Tag Address:

1. Select the tag and use the pop-up menu to open the "Properties" dialog box.
2. In the "General Information" tab, select the desired data type (for example, signed 8-bit value).
3. Click on the "Select" button. The "Address Properties" dialog window opens.

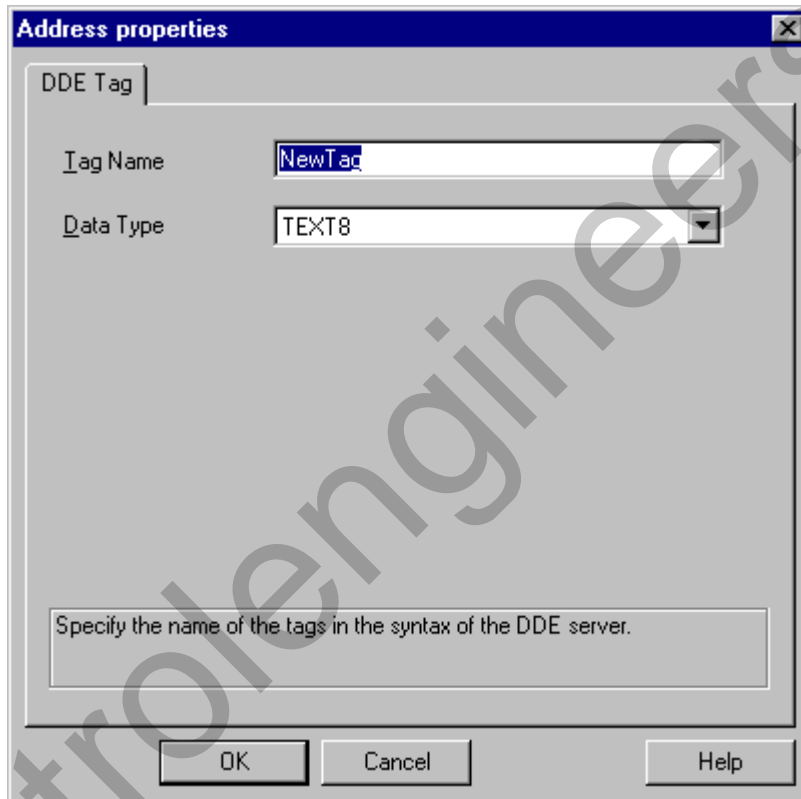

4. In the "Tag Name" box, enter the name of the tag in the DDE server (for example, with Excel for the cell in the third line and the second column "l3c2"). Letters of the alphabet must always be written in lower case.
5. In the "Data Type" box, also specify the data type in the DDE server (for example, "WORD" for an unsigned 16-bit value).

### Note

Although the data are generally transmitted in text format ("CF\_TEXT") over the DDE channel, it is absolutely necessary to specify matching data types for the DDE client and the DDE server.

### 4.8.3 Connection Parameters

Data access by means of a DDE channel is possible both locally and remotely. The DDE client sets up a DDE connection to the DDE server and then transmits in Windows standardized DDE commands to access the tags.

No additional communication module is needed in the WinCC system. Communication takes place locally by means of a DDE channel in the operating system. If the DDE server is remote, the network function of Windows is employed. In this case, the program "Netdde.exe" and the network adapter of Windows are used.

#### How to Configure the Communication Parameters:

1. Select the connection and use the pop-up menu to open the "Properties" dialog box.
2. Select the "DDE Connection" tab.

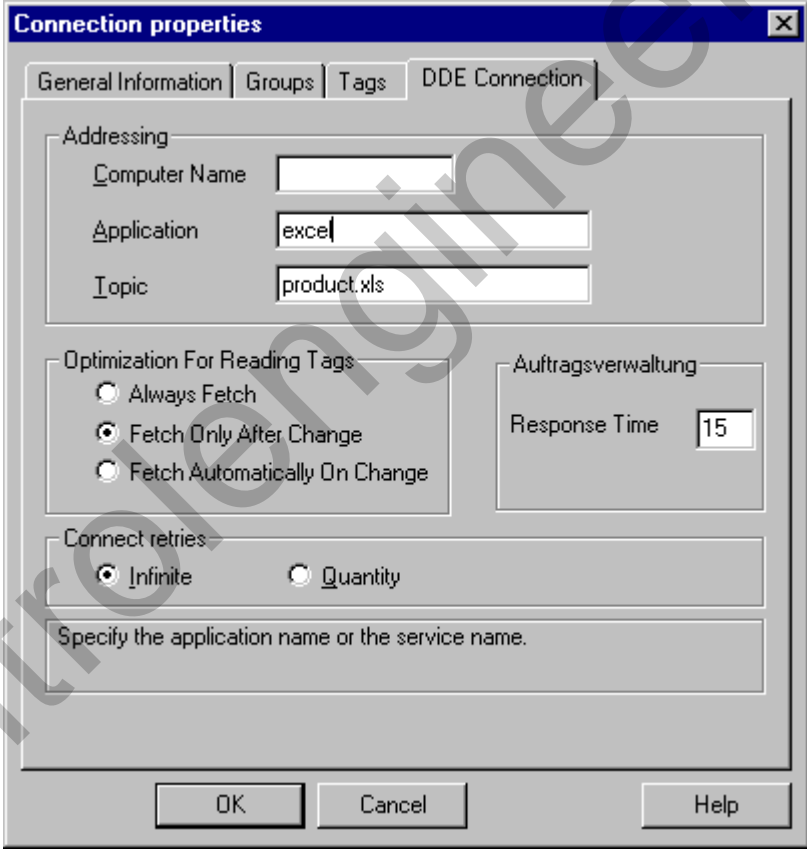
 The screenshot shows the "Connection properties" dialog box with the "DDE Connection" tab selected. The "Addressing" section contains three text boxes: "Computer Name" (empty), "Application" (containing "excel"), and "Topic" (containing "product.xls"). The "Optimization For Reading Tags" section has three radio buttons: "Always Fetch" (unselected), "Fetch Only After Change" (selected), and "Fetch Automatically On Change" (unselected). The "Auftragsverwaltung" section has a "Response Time" spinner box set to "15". The "Connect retries" section has two radio buttons: "Infinite" (selected) and "Quantity" (unselected). At the bottom, there is a text box labeled "Specify the application name or the service name." and three buttons: "OK", "Cancel", and "Help".

3. If the DDE server is not located on your computer, use the "Computer Name" box to enter the name of the computer from which the data are to be requested by means of the DDE connection.
4. In the "Application" box, enter the name of the server application (in our example, "excel" for the table calculation program Excel).
5. In the "Topic" box, specify the file being processed by the application (for example, "product.xls table").

6. In the "Procedure for Reading Tags" area, specify the criteria for reading the tags. The following assignment applies:

WinCC Side	DDE Function
Always fetch	REQUEST/POKE COLD
Fetch only after change	ADVISE/POKE HOT
Fetch automatically upon change	ADVISE/POKE WARM

7. In the "Response Time" box, you should enter a value greater than 0.
8. In the "Connection Setup Attempts" area, you should select the "Infinite" box. In this case, an attempt will be made to set up the connection until the connection setup is successful.

---

**Note**

The DDE server application and the file specified in the "Topic" box must be started in the ONLINE mode during setup of the DDE connection.

If you have questions concerning the function of the Windows DDE interface and assigning parameters to the DDE interface for external applications, consult the appropriate documentation from Microsoft and from the manufacturer of the external application.

---

## 4.9 WinCC "Channel Diagnosis"

The WinCC "Channel Diagnosis" provides the WinCC user with a summary over the states of the active connections. The "Channel Diagnosis" is both an interface for displaying state and diagnostic information of the channel units as well as an operator interface for the configuration of the diagnostic display:

- For the user, who wants to display information about the communication state (state/statistics display in the process screen).
- For analyzing and correcting errors (text output in a log file).
- For supporting the hotline in isolating communication problems (text output in "trace" files).

The diagnosis module can be inserted into a process screen as an ActiveX Control or be started as an independent application via the WinNT "Start" menu.

The following files are used to store the diagnostic information:

### Log File

For each configured WinCC channel, the "Channel Diagnosis" will automatically create a log file with the name <Kanal Name>.log. Important information and errors are stored there. The text information is identical for all channels. The file creation and text output to that file is not configurable.

The log file contains start/end messages, version information, information about communication errors, etc.

Each file entry receives a time and date stamp followed by the flag name and is immediately written to the hard disk, to reduce loss of information in the event of a power failure.

Example of a log entry:

```
1999-04-01 12:00:24,524 INFO S7 channel DLL started!
1999-04-01 12:00:26,096 ERROR Illegal tag address "nCPU3_1"!
1999-04-01 12:00:27,428 INFO S7DOS release: @(#)TIS-Block Library DLL Version
C5.0.17.3-REL5,0,17,47,3-BASIS
1999-04-01 12:00:27,428 INFO S7DOS version: V5.0 / 0
1999-04-01 12:00:27,428 INFO S7CHN version: V5.0 / Mar 1 1999 / 22:36:40
1999-04-01 12:00:27,428 INFO S7 channel unit "Industrial Ethernet" activated!
1999-04-01 12:00:27,468 ERROR Can not connect to "CPU_4": Error code 0xFFDF
42C2!
1999-04-01 12:00:27,538 INFO S7 channel unit "MPI" activated!
```

### Trace File

The creation and text output into a trace file of the name <Kanal Name>.trc is configurable. If the trace output is activated, a message is displayed notifying you that the runtime connection has been affected.

Each entry into the trace file receives a time stamp followed by the flag name.

If the "Trace" function has been activated, all log outputs will also be written into the trace file.



Example of a trace file entry:

```

09:21:54,134 0000016f STARTUP Trace starting at : 1999-04-01 09:21:54,124 Local Time
09:21:54,134 0000016f STARTUP | TraceFileName :
C:\Siemens\WinCC\Diagnose\SIMATIC_S7_PROTOCOL_SUITE.TRC
09:21:54,134 0000016f STARTUP | TraceFileCount : 1
09:21:54,134 0000016f STARTUP | TraceFileSize : 1400000
09:21:54,134 0000016f STARTUP | TraceFlags : f8000000
09:21:54,134 0000016f INFO S7 channel DLL started!
09:21:54,134 0000016f INFO 0x0 S7 channel DLL started! -----
09:21:56,007 0000016f INFO S7DOS release: @(#)TIS-Block Library DLL Version
C5.0.17.3-REL5,0,17,47,3-BASIS
09:21:56,007 0000016f INFO S7DOS version: V5.0 / 0
09:21:56,007 0000016f INFO S7CHN version: V5.0 / Mar 1 1999 / 22:36:40
09:21:56,007 0000016f INFO 0x0 S7CHN version: V5.0 / Mar 1 1999 / 22:36:40
09:21:56,007 0000016f INFO S7 channel unit "Industrial Ethernet" activated!
09:21:56,007 0000016f INFO 0x0 0200 S7 channel unit "Industrial Ethernet" activated!
09:21:56,017 0000016f INFO 0x0 0201 Connection state : CS_CONIN
09:21:56,017 0000018a INFO 0x0 0201 Connection state : CS_NOINI
09:21:56,017 0000018a ERROR Cannot connect to "CPU_4": Error code 0xFFDF 42C2!
09:29:39,283 0000016f INFO S7 channel unit "Industrial Ethernet" deactivated!
09:29:39,283 0000016f INFO 0x0 0200 S7 channel unit "Industrial Ethernet"
deactivated!
  
```

---

#### Note

The outputs into the trace and log files are exclusively made in English.  
Both files are stored in the "Diagnosis" folder of the WinCC folder structure.  
The current counter values are not output to these files.

---

## 4.9.1 Structure

The WinCC "Channel Diagnosis" contains two tabs: one for displaying the connection states and another one for the configuration.

### 4.9.1.1 "Channels/Connections" Tab

In runtime, this tab displays the connection states of the channel unit and their configured connections:

- Left side: In a tree display, the channel units, their connections and their corresponding states symbolized by icons.
- Right side: Counters and values of the selected channel/connection.

---

#### Note

In the configuration mode, there is no display of the configured channels and connections.  
The type and number of displayed counters is channel-specific.  
Only channels supporting the diagnosis function are listed.

---

### Display if a Channel has been selected

For illustrative purposes, the tab of the "SIMATIC S7 Protocol Suite" channel is shown.

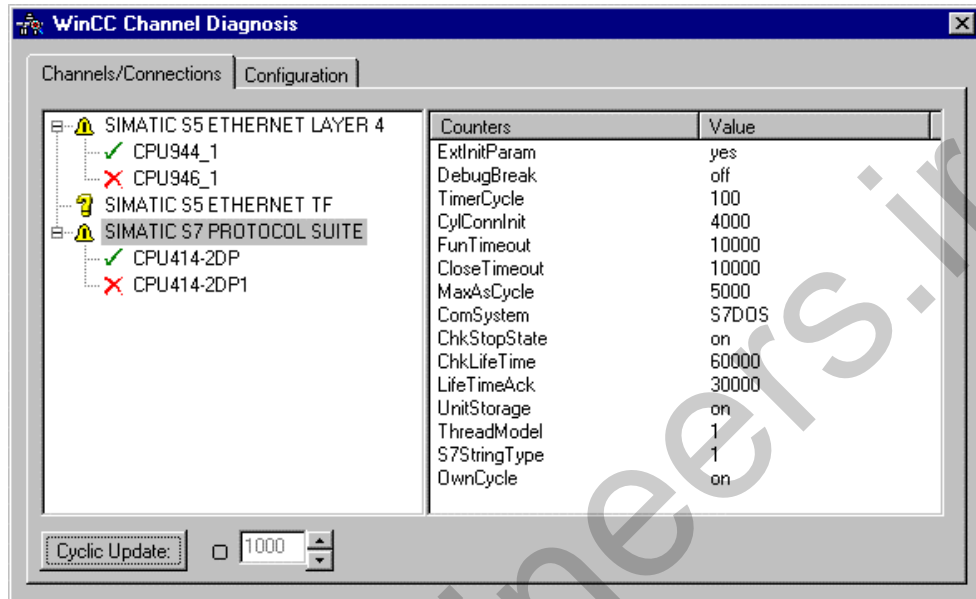

Field/Icon	Description
✓	State Display: Channel is operational without restrictions.
⚠	State Display: Channel is operational with restrictions, e.g. one of the channel connections has errors.
?	State Display: No information regarding the channel state can be provided.
✗	State Display: Channel or all connections of the channel have errors.
"Counter" and "Value" Columns	Contain channel-internal information, which will not be described here.
"Cyclic Update"	Activates the cyclic update of the display. The update cycle is set in the field next to it.
Numerical Entry Field	The update cycle in milliseconds is set in here.

**Display if a Connection has been selected**

For illustrative purposes, the tab of a selected connection of the "SIMATIC S7 Protocol Suite" channel is shown.

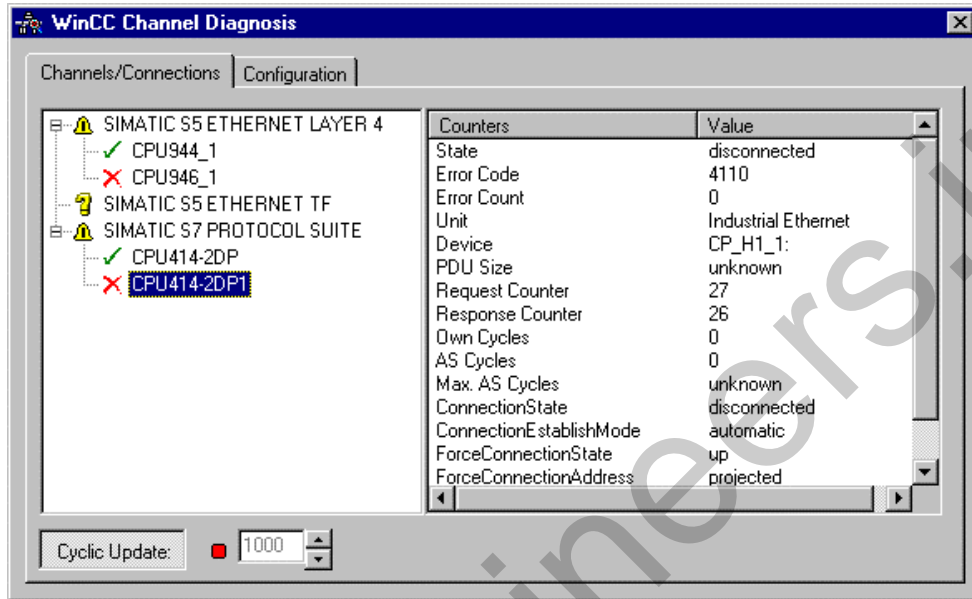

Field/Icon	Description
✓	State Display: Connection is operational without restrictions.
⚠	State Display: Connection is operational with restrictions.
?	State Display: No information regarding the connection state can be provided.
✗	State Display: Connection error.
"Counter" and "Value" Columns	Error-sensitive help information is available for the "Error Code" entry, which can be accessed via the pop-up menu. The other lines contain channel-internal information, which will not be described here.
"Cyclic Update"	Activates the cyclic update of the display. The update cycle is set in the field next to it.
Numerical Entry Field	The update cycle in milliseconds is set in here.

### 4.9.1.2 "Configuration" Tab

This tab displays the channel-specific flags and the settings pertaining to the trace files of a selected channel.

For illustrative purposes, the tab of the "SIMATIC S7 Protocol Suite" channel is shown.

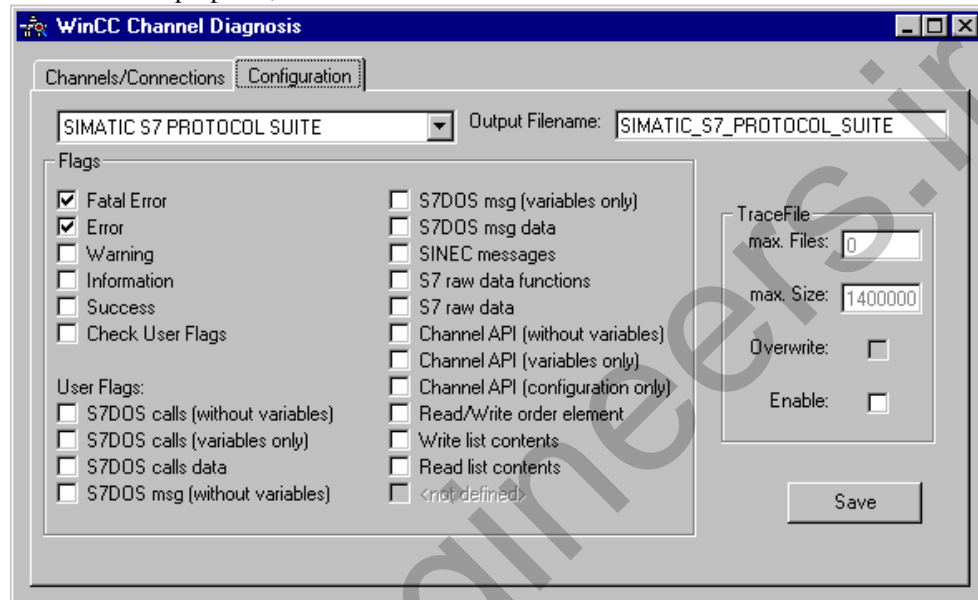

Field/Area	Description
Drop-Down List	Select a configured channel from this list - the tab will display its current settings, which can then be edited.
Output File Name	Name of the log/trace file. This entry is optional. If no entry is made, the name of the channel unit is used.
"Flags" Area	The flags, which initiate the entries into the trace file, are defined here. The standard flags "Fatal Error", "Error", "Warning", "Information", "Success" and "Check User Flags" are always displayed. The user flags are enabled by the "Check User Flags" standard flag. User flags are only configurable/displayed, if they are supported by the channel.
max. Files	Specifies the maximum number of trace files.
max. Size	Specifies the maximum size of the individual trace files. Maximum Size: 1.4 Mbytes (floppy disk capacity)
Overwrite	If set, existing trace files of the channel are overwritten once they reach the maximum size (older data is overwritten first).
Enable	Activates the trace function and makes the other fields of the "Trace File" area active. Entries made in the "Trace File" area only become effective after restarting runtime.
"Save" Button	Saves the settings made.

controlengineers.ir

# Index

## 3

- 3964R 4-3
  - Bit-wise access 4-5
  - Byte-wise access 4-5
  - Data types 4-3
  - Tag addresses 4-4

## A

- Allen Bradley Serial DF1 4-1
- Applicom Multi Protocol Interface 4-1
- AR\_SEND 4-44
  - for a tag 4-48
  - for multiple tags 4-48
  - optimized 4-50
  - Subnumbers 4-47
- AS511 4-9
  - Byte-wise access 4-11, 4-12
  - Data types 4-9
  - S5-AS511 4-9
  - Tag addresses 4-10

## B

- Bit-wise Access
  - 3964R 4-5
  - AS511 4-11
  - S5 Ethernet Layer 4 4-20
  - TI Ethernet Layer 4 4-77
- Byte-wise Access
  - 3964R 4-5
  - AS511 4-12
  - S5 Ethernet Layer 4 4-21
  - TI Ethernet Layer 4 4-77

## C

- Channel Diagnosis 4-87
  - Configuration 4-91
- Channel Unit 3-1, 3-2
  - Connection parameter 4-7, 4-14
  - DDE 4-83, 4-85
  - Industrial Ethernet 4-32, 4-55
  - MPI 4-32, 4-51
  - Named connections 4-57
  - Named Connections 4-32
  - PROFIBUS 4-32, 4-53

- S5 Application 4-30
- S5 application (CP 1413-x) 4-25
- S5-AS511 4-9, 4-14
- S5-RK512 4-3, 4-7
- S5-Transport 4-23
- S5-Transport (CP 1413-x) 4-15
- Slot PLC 4-32
- Slot-PLC 4-59
- System parameter 3-2
- TCP/IP 4-32, 4-60
- TI 505 Unit #1 4-74
- TI Ethernet Layer 4 (CP 1413-x) 4-81
- TI505 Unit #1 4-72
- TI-Ethernet (CP 1413-x) 4-75
- Channels 1-1
- Communication 1-1
  - Prerequisites 2-1
- Communication Driver 3-1, 3-2
- Communications Parameter 3-2
- Connection 3-2
  - Status of the connection 3-2
- Connection Parameter
  - 3964R 4-7
  - AS511 4-14
  - Industrial Ethernet 4-55
  - MPI 4-51
  - PROFIBUS 4-53
  - S5 Ethernet Layer 4 4-23
  - S5 Ethernet TF 4-30
  - Slot-PLC 4-59
  - TCP/IP 4-60
  - TI Ethernet Layer 4 4-81
  - TI Serial 4-74
  - Windows DDE 4-85
- CP 1413 4-16, 4-55, 4-79
- CP 1430 TF 4-16, 4-26
- CP 1434 TF 4-79
- CP 342-5 4-51, 4-53
- CP 343-1 4-55
- CP 443-1 4-55
- CP 443-5 4-51, 4-53
- CP 5412/A2 4-53
- CP 5511 4-51
- CP\_H1\_1 4-34
- CP\_H1\_2 4-34
- CP\_L2\_1 4-34
- CP\_L2\_2 4-34
- CP1413 4-26
- CP-TCPIP 4-34

**D**

Data Types  
  3964R 4-3  
  AS511 4-9  
  S5 Ethernet Layer 4 4-18  
  S5 Ethernet TF 4-27  
  S7 Protocol Suite 4-36  
  TI Ethernet Layer 4 4-75  
  TI Serial 4-72  
  Windows DDE 4-83  
DDE 4-85  
  Windows DDE 4-1  
Device Name 4-34  
Diagnostics 4-87  
Driver Connections 3-1

**E**

Ethernet Layer 4 4-15  
Ethernet TF 4-25

**H**

H/F Systems 4-57

**I**

Industrial Ethernet 4-25  
  Connection parameter 4-55

**L**

Layer 4  
  Byte-wise access 4-20, 4-21  
  Connection parameter 4-23  
  Data types 4-18  
  System parameter 4-16  
  Tag addresses 4-18, 4-19  
  Transport parameter 4-16  
Logbook File 4-87  
Logical Connection 3-2  
  Status of the connection 3-2  
Logical Device Name 4-34

**M**

ModBus Serial 4-1  
MPI 4-34  
  Connection parameter 4-51  
  System Parameter 4-34

**N**

Named Connections  
  Connection parameter 4-57

**P**

Process Communication 2-1  
Process Tag 3-3  
PROFIBUS  
  Connection parameter 4-53  
PROFIBUS FMS 4-1  
Programmers Port AS511 4-9

**S**

S5 Application (CP 1413-x) 4-30  
S5-AS511 4-14  
S5-RK512 4-3, 4-7  
S5-Transport (CP1413-x) 4-23  
S7 Protocol Suite  
  AR\_ID 4-47  
  AR\_SEND 4-44, 4-48, 4-50  
  AR\_SEND Subnumbers 4-47  
  BRCV 4-41, 4-43  
  BSEND 4-41, 4-43  
  Connection parameter 4-51, 4-53, 4-55,  
  4-57, 4-59, 4-60  
  Data types 4-36  
  Logical device name 4-34  
  Raw data tag 4-39, 4-40, 4-41, 4-43  
  Software redundancy 4-62, 4-68  
  System Parameter 4-33, 4-34  
  Tag addresses 4-37  
S7-300 4-37, 4-40  
S7-400 4-37, 4-40  
S7-5412 4-37, 4-40  
Serial 3964R 4-3  
SIMATIC  
  S5 4-3, 4-9  
  S5 Ethernet Layer 4 4-1, 4-15  
  S5 Ethernet TF 4-1, 4-25  
  S5 Programmers Port AS511 4-1, 4-9  
  S5 Serial 3964R 4-1, 4-3  
  S5-115U/H 4-15, 4-25  
  S5-135U 4-15, 4-25  
  S5-155U/H 4-15  
  S7 Protocol Suite 4-1, 4-32  
  S7-300 4-32  
  S7-400 4-32  
  TI Ethernet Layer 4 4-1, 4-75  
  TI Serial 4-1, 4-72  
  TI505 4-72, 4-75

SIPART DR 4-1  
Slot-PLC 4-34  
    Connection parameter 4-59  
Software Redundancy 4-62, 4-68  
Status  
    Channel 4-88  
    Connection 4-88  
Status of the Connection 3-2  
System Parameter 3-2  
    S5 Ethernet Layer 4 4-16  
    S5 Ethernet TF 4-26  
    S7 Protocol Suite 4-33, 4-34  
    TI Ethernet Layer 4 4-79

## T

Tag 3-3  
Tag Addresses  
    3964R 4-4  
    AS511 4-10  
    S5 Ethernet Layer 4 4-18, 4-19  
    S5 Ethernet TF 4-28  
    S7 Protocol Suite 4-37  
    TI Ethernet Layer 4 4-76  
    TI Serial 4-73  
    Windows DDE 4-84  
Tag Group 3-2  
TCP/IP  
    Connection parameter 4-60  
TF  
    Connection parameter 4-30  
    Data types 4-27  
    System parameter 4-26  
    Tag addresses 4-28  
    TF protocol 4-25  
TI 505 Unit #1 4-74  
TI Ethernet Layer 4  
    Byte-wise access 4-77  
    Connection parameter 4-81  
    Data types 4-75  
    System parameter 4-79  
    Tag addresses 4-76  
    Transport parameter 4-79  
TI Ethernet Layer 4 (CP 1413-x) 4-81  
TI Serial  
    Connection parameter 4-74  
    Data types 4-72  
    Tag addresses 4-73  
Trace-File 4-87  
Transport Parameter  
    S5 Ethernet Layer 4 4-16  
    TI Ethernet Layer 4 4-79  
TTY-Interface 4-9, 4-14

## W

Windows DDE 4-1, 4-83  
    Connection parameter 4-85  
    Data types 4-83  
    Tag Addresses 4-84



controlengineers.ir

## SIMATIC HMI

## WinCC

Manual  
Volume 1 / 2

### Volume 1

Preface	1
System Overview	2
Authorization	3
WinCC Explorer	4
Channels	5
Report Designer	6
User Administrator	7

### Volume 2

Graphics Designer	8
Alarm Logging	9
Tag Logging	10
Text Library	11
Global Script	12
Cross Reference	13

This manual is part of the documentation package with the order number: 6AV6392-1XA05-0AB0

Edition August 1999

WinCC®, SIMATIC®, SIMATIC NET®, SINEC® and STEP® are Siemens registered trademarks.

All other product and system names in this manual are (registered) trademarks of their respective owners and must be treated accordingly.

(The reproduction, transmission or use of this document or its contents is not permitted without express written authority. Offenders will be liable for damages. All rights, including rights created by patent grant or registration of a utility model or design, are reserved.)

(We have checked the contents of this manual for agreement with the hardware and software described. Since deviations cannot be precluded entirely, we cannot guarantee full agreement. However, the data in this manual are reviewed regularly and any necessary corrections included in subsequent editions. Suggestions for improvement are welcomed.)

© Siemens AG 1994 - 1999 All rights reserved

Technical data subject to change

C79000-G8276-C159

Printed in the Federal Republic of Germany

Siemens Aktiengesellschaft

# Table of Contents

<b>1</b>	<b>General Information.....</b>	<b>1-1</b>
<b>2</b>	<b>Reports .....</b>	<b>2-1</b>
2.1	Reports in Page Layout.....	2-2
2.1.1	Page Layout Structure.....	2-2
2.1.2	Cover Sheet.....	2-3
2.1.3	Contents of Report .....	2-4
2.1.4	Final Page .....	2-4
2.1.5	Printable Area.....	2-5
2.1.6	Body of the Page.....	2-6
2.1.7	Static Part of the Report.....	2-6
2.1.8	Dynamic Part of the Report.....	2-7
2.2	Reports in Line Layout .....	2-8
2.2.1	Line Layout Structure .....	2-8
2.2.2	Page Size in the Line Layout.....	2-9
2.2.3	Header in the Line Layout .....	2-10
2.2.4	Table in the Line Layout.....	2-10
2.2.5	Footer in the Line Layout.....	2-11
2.3	Output of the Reports .....	2-12
2.3.1	LAYOUTS in the Report Designer.....	2-13
2.3.2	Print Jobs in the Report Designer .....	2-16
2.3.3	"Properties" Dialog for Print Jobs.....	2-19
2.3.4	Deleting an Existing Print Job in the Report Designer .....	2-23
2.4	System Layouts and Print Jobs of WinCC .....	2-24
2.4.1	System Layouts for the Project Documentation .....	2-25
2.4.2	System Layouts for On-Line Reporting .....	2-26
2.4.3	Print Jobs in the Release .....	2-26
<b>3</b>	<b>Editors .....</b>	<b>3-1</b>
3.1	Editor for Page Layouts.....	3-1
3.1.1	General Information about the Editor .....	3-2
3.1.2	Color Palette.....	3-2
3.1.2.1	Assigning a Standard Color.....	3-3
3.1.2.2	Assigning a User-Defined Color .....	3-3
3.1.3	Object Palette .....	3-3
3.1.4	Static objects .....	3-4
3.1.5	Dynamic objects .....	3-5
3.1.6	System objects .....	3-6
3.1.6.1	Drawing an Object.....	3-6
3.1.6.2	Selecting an Object .....	3-7
3.1.6.3	Changing Object Properties .....	3-8
3.1.6.4	Moving an Object with the Mouse .....	3-9
3.1.6.5	Sizing an Object with the Mouse .....	3-9
3.1.6.6	Changing the Start Angle/End Angle with the Mouse .....	3-10
3.1.7	Style Palette .....	3-10
3.1.7.1	Changing the Line Style .....	3-11
3.1.7.2	Changing the Line Weight.....	3-11

3.1.7.3	Changing the Fill Pattern .....	3-12
3.1.8	Alignment Palette .....	3-12
3.1.9	Zoom Palette .....	3-13
3.1.10	Menu Bar .....	3-14
3.1.11	File Menu .....	3-15
3.1.12	Edit Menu .....	3-15
3.1.13	View Menu .....	3-16
3.1.14	Insert Menu .....	3-17
3.1.15	Arrange Menu .....	3-17
3.1.16	Options Menu .....	3-18
3.1.17	Window Menu .....	3-20
3.1.18	Standard Palette .....	3-20
3.1.19	Text Palette .....	3-22
3.1.20	Status Bar .....	3-22
3.1.21	Object Properties .....	3-23
3.1.21.1	Changing Attributes .....	3-25
3.2	Editor for Line Layouts .....	3-34
3.2.1	Menu Bar .....	3-34
3.2.2	Standard Palette .....	3-35
3.2.3	Status Bar .....	3-35
<b>4</b>	<b>Connecting Report Layouts with the Applications .....</b>	<b>4-1</b>
4.1	Selecting the Data for Project Documentation .....	4-1
4.1.1	Selecting Message Data for the Report Output in the Alarm Logging Configuration System .....	4-1
4.1.1.1	Selecting Single Messages in the Alarm Logging Configuration System .....	4-2
4.1.2	Selecting Data for the Report Output in the WinCC Explorer .....	4-3
4.1.2.1	Selecting a Computer in the WinCC Explorer .....	4-3
4.1.2.2	Selecting Tags in the WinCC Explorer .....	4-4
4.1.3	Selecting Data for the Report Output in Global Scripts .....	4-7
4.1.3.1	Selecting Actions and Functions .....	4-8
4.1.4	Selecting Archive Data for the Report Output in Graphics Designer .....	4-9
4.1.4.1	Selecting Picture Data and Objekt Data in the Graphics Designer .....	4-10
4.1.4.2	Selecting Statistical Data on the Picture in the Graphics Designer .....	4-11
4.1.4.3	Selecting attributes of a picture in the Graphics Designer .....	4-12
4.1.4.4	Selecting Scripts for the Output in Graphics Designer .....	4-13
4.1.5	Selecting Archive Data for the Report Output in the Tag Logging Configuration System .....	4-14
4.1.5.1	Selecting Archives for the Report Output in the Tag Logging Configuration System .....	4-15
4.1.5.2	Setting Archive Tags for the Report Output in the Tag Logging Configuration System .....	4-18
4.1.6	Selecting the Text Library Data for the Report Generation .....	4-20
4.1.6.1	Selecting the Text Library Languages .....	4-20
4.1.7	Defining Objects for the Project Document in Alarm Logging Runtime .....	4-22
4.1.8	Defining Objects for the Project Document in Tag Logging Runtime .....	4-26
4.2	Object Types and Their Properties .....	4-32

# 1 General Information

The Report Designer is a part of the WinCC basic package that provides functions for the "creation" and "output of reports."

In this description, the term "creating" means creating the report layout and the term "output" means printing out the reports. During the output, the configured wildcards are filled (provided) with the appropriate data dynamically.

The following two editors are available for creating reports:

- Editor for Page Layout
- Editor for Line Layout

You can find more about the terms page and line layout in the "Reports in Page Layout" and "Reports in Line Layout" chapters.

The following selection dialogs are available for defining the data (configuration) to be output in the reports. The dialogs are arranged according to their applications:

- Scripts in the Graphics Designer
- Alarm Logging CS
- Alarm Logging Runtime
- WinCC Explorer
- Global Scripts
- Graphics Designer
- Tag Logging CS
- Tag Logging RunTime
- Text Library
- User Administrator

Use the dynamic objects of the Report Designer for the data output. These dynamic objects must be connected to the appropriate applications.

The selection of data for the output is application-dependent and is executed either when the layout is created, when the print job is created, or when the printout is started directly. Not all of the applications offer all three possibilities for data selection.

During the report output, the dynamic objects are provided the current values.

Static and system objects are available for arranging the reports visually.

For the report output, you must set the time for the output, and the output medium. The system offers the following selection possibilities:

- Print start by user
- At a preselected time
- Cyclic output
- Output to the screen
- Output to a preselected printer
- Output to a file
- Output to a page area

---

**Note:**

You can make direct use of the system layouts supplied with the product, or you can copy them and then customize them to meet your requirements. All system files begin with a @ character.

---

The "Simatic Manager" S7 programming tool allows you to integrate WinCC objects into the S7 environment. For additional information refer to the S7 documentation.

## 2 Reports

In WinCC, you use reports for documenting your configured data (project documentation) and for reporting online data (sampling, batch, and alarm reports, to name just a few). The corresponding application has to be activated at runtime to output online data.

The structure and configuration of these reports is mostly identical. The most significant difference is in the connection of the data with the dynamic objects in the report layout and in the print output startup.

The Report Designer differentiates among reports according to their layout and their data contents.

- Layout division by:
  - Page layout
  - Line layout

In page layout, the Report Designer provides you with the static, dynamic, and system objects for the visual structure.

If you follow the rules for validity (with a connection to **exactly** one application per page layout, multiple dynamic objects in the layout are allowed), reports can be nested. This way, you can document a complete WinCC project by means of one report and the corresponding print job.

- For the project documentation:
  - Data from the Graphics Designer
  - Data from Alarm Logging
  - Data from the WinCC Explorer
  - Data from Global Scripts
  - Data from Tag Logging
  - Text Library
  - User Administrator
- The following are available for on-line reporting:
  - Message sequence report
  - Message archive report
  - Archive report

---

### Note:

When you save the page layout, the editor checks to see if the report fulfills the validity rules for embedding in other layouts. You can find the result of the test in the "Context" attribute of the layout.

---



## 2.1 Reports in Page Layout

### 2.1.1 Page Layout Structure

Page-oriented reports are divided according to different pages and print areas. They can contain static, dynamic, and system objects.

- Page division:
  - Cover Sheet
  - Contents of Report
  - Final Page
- Print area division:
  - Printable area
  - Body of the page

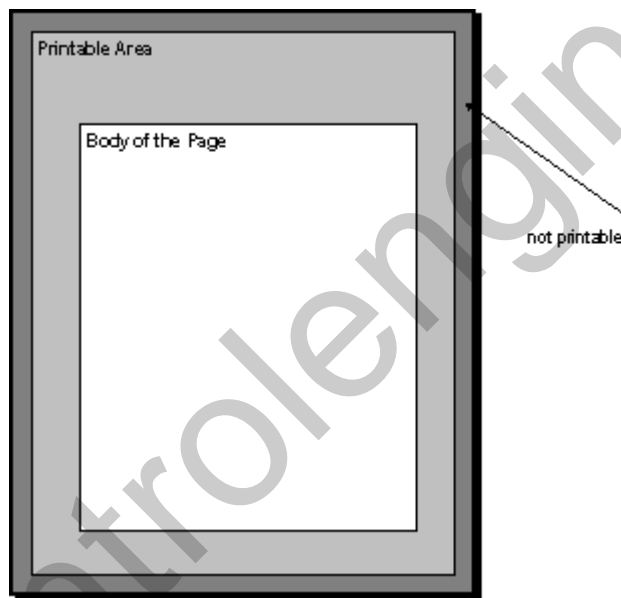

Report Designer supports both print areas. You can set the margins for the printable area and for the body of the report page for each page layout.

- Page layout objects are:
  - Static objects
  - Dynamic objects
  - System objects

These objects are described in more detail in the "Object Types and Their Properties" chapter.

Report Designer provides two layers for placing the objects. Both layers are within the printable area.

- The layers for arranging objects in the layout are:
  - Static part of the report (static objects, system objects)
  - Dynamic part of the report (static objects, dynamic objects)

---

**Note:**

After you start the editor, you are located in the dynamic part of the page layout.

---

## 2.1.2 Cover Sheet

You can create an individual cover sheet for each page layout. However, creation and output of a cover sheet is optional. The system presets the output of the cover sheet as a default.

Click on "Properties" in the "View" menu or on the "Properties" button in the standard palette. In the "Object Properties" window that opens, under the option "Miscellaneous" in the object "Layout" , you can change this default setting by means of the attribute "Cover Sheet".

The cover sheet has a static and a dynamic part (configuration layer).

**Important:**

- If you use dynamic objects in the cover sheet, it is possible that only parts of these data are included when the report is output. This is the case when the data of dynamic objects do not fit on the cover sheet. The cover sheet always has only one page - **no page break!**

---

**Note:**

You can insert dynamic objects only in the dynamic part of the cover sheet. System objects are inserted only in the static part.

---

### 2.1.3 Contents of Report

Create the structure and the contents of the report for the output in this part of the page layout. There are static, dynamic, and system objects available for defining the contents of the report.

The contents of the report section has a static and a dynamic part (configuration layer).

The dynamic part for the contents of the report is divided among the individual pages during output if necessary, since the number or amount of data is not known until the time for output.

**Important:**

- While you are defining the page layout, you cannot foresee with absolute certainty among how many pages the dynamic part is divided. The size of the dynamic tables and text boxes is determined by the data that are present when the output occurs.

---

**Note:**

The static part can contain static and system objects. The dynamic part can contain static and dynamic objects.

---

### 2.1.4 Final Page

You can create a final page for each individual page layout. However, creation and output of a final page is optional. As a default, the system does not preset the output of the final page.

Click on "Properties" in the "View" menu or on the "Properties" button on the standard palette. In the "Object Properties" window that opens, under the option "Miscellaneous" in the object "Layout", you can change this default setting by means of the attribute "Cover Sheet".

The final page has a static and a dynamic part (configuration layer).

---

**Note:**

If you use dynamic objects in the final page, it is possible that only parts of these data are included when the report is output. This is the case when the data of dynamic objects do not fit on the final page. The final page always has only one page - **no page break!**

The static part can contain static and system objects. The dynamic part can contain static and dynamic objects.

---

## 2.1.5 Printable Area

Common printers cannot print the entire surface of a page but, due to the technology used, leave page margins unprinted. It therefore makes sense for you to set the borders of the printable area for the page layout.

Another reason to set the printable area is so that you can maintain a border for a notebook.

### How to Set the Printable Area:

1. Click the left mouse button on the active window in the report.
2. Click the right mouse button to open the pop-up menu.
3. Click on "Properties..." to open the "Properties" dialog window.
4. In the subject tree, select the subject "Geometry". The corresponding attributes are displayed in the right half of the window.
5. Double click on the name of the appropriate attribute (**Left, Top, Right, or Bottom print margin**) or on the displayed value in the "Static" column. The input dialog box opens.

or

Click the right mouse button on the value that is displayed in the "Static" column. The pop-up menu opens. Select the "Edit" menu item to open the input dialog box, for example:

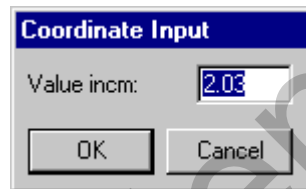

6. Enter the new value for the attribute.

## 2.1.6 Body of the Page

It makes sense to leave margins available in the printable area for headers and footers or for a company logo and to use only a part of the printable area for the output of the report data. This area that is defined within the printable area is known as the "Body of the Page".

### How to Set the Body of the Page:

1. Click the left mouse button on the active window in the layout.
2. Click the right mouse button to open the pop-up menu.
3. Click on "Properties..." to open the "Properties" dialog window.
4. Select the "Geometry" subject in the subject tree. The corresponding attributes are displayed in the right half of the window.
5. Double click on the name of the appropriate attribute (**Left, Top, Right, or Bottom dynamic margin**) or on the displayed value in the "Static" column. The input dialog box opens.

or

Click the right mouse button on the value that is displayed in the "Static" column. The pop-up menu opens. Select the "Edit" menu item to open the input dialog box, for example:

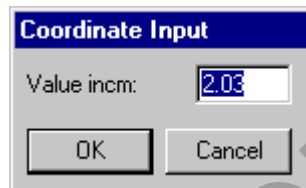

6. Enter the new value for the attribute.

## 2.1.7 Static Part of the Report

The static part (configuration layer) of a page in the page layout stretches over the entire printable area of the page. You can define the static part for the cover sheet, the contents of the report, and the final page individually.

All of the subsequent pages in the contents of the report repeat the same static part.

---

### Note:

You can insert only static objects and system objects in the static part of a report.

---

### 2.1.8 Dynamic Part of the Report

The dynamic part (configuration layer) covers the page area defined by the body of the page in the page layout.

You can define the dynamic part for the cover sheet, the contents of the report, and the final page individually. The dynamic part of the cover sheet and the final page must fit on one page each or it will be cut off.

The dynamic part for the contents of the report is continued over the individual subsequent pages in the contents of the report during output.

While you are defining the page layout, you cannot foresee with absolute certainty the number of pages among with the dynamic part will be divided. The size of the dynamic tables and text boxes is determined by data that are not present until the output occurs. -

**You cannot make a statement about the number of pages!**

---

**Note:**

You can insert only static objects and dynamic objects in the dynamic part of a report.

---

## 2.2 Reports in Line Layout

### 2.2.1 Line Layout Structure

In practice, line-by-line printing is used for current and synchronous documentation. To meet this requirement, WinCC offers line-by-line printing on an appropriate matrix printer. Output to this matrix printer is carried out exclusively by means of a local, parallel interface on the computer.

The necessity of printing the messages to a file is not foreseen.

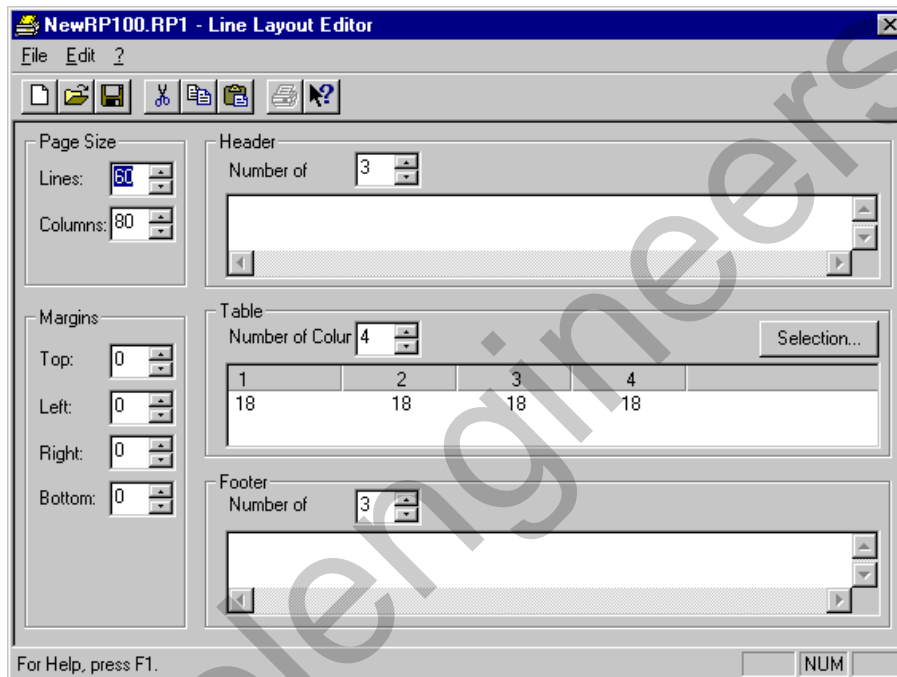

You can define the structure of the line layout separately for every layout. You can set up the line layout in the following ways:

- Defining the Pages:
  - Setting the page size and
  - Setting the page margins
- Setting the Page Contents:
  - Header
  - Contents of the report
  - Footer

The configuration and output of headers and footers are optional.

---

#### Note:

The line layout can only report messages from the message sequence report. These messages are set in Alarm Logging.

---

## 2.2.2 Page Size in the Line Layout

For every line layout, you can define the page size and the page margins any way you want within the allotted ranges.

The following ranges apply for the line layout:

- **Lines:**  
The value for the number of lines must be between 1 and 400.
- **Columns:**  
The value for the number of columns must be between 20 and 400.
- **Margins:**  
The value for the page margins (top, left, right, and bottom) must be between 0 and 30.

### How to Set the Page Size:

1. In the page size area, click on the "Lines" box and enter a valid value (1 to 400).
  2. In the page size area, click on the "Columns" box and enter a valid value (20 to 400).
- or
- Use the spin box to select the desired value.

### How to Set the Page Margins:

1. In the page margins area, click on the "Top" box and enter a valid value (1 to 30).
  2. In the page margins area, click on the "Left" box and enter a valid value (1 to 30).
  3. In the page margins area, click on the "Right" box and enter a valid value (1 to 30).
  4. In the page margins area, click on the "Bottom" box and enter a valid value (1 to 30).
- or
- Use the spin box to select the desired value.

### Printer Settings:

The number of columns (= characters per line) set in the "Paper Size" field of a "Line Printer Layout" must be supported by the printer specified. If the number of columns is greater than can be supported by the selected printer, then a smaller font or character width must be set at the printer, since a carryover of a column text into a new line would disturb the column formatting.

The font and character width settings are specific to the printer used. For additional information, please refer to the printer manual.

---

### Note:

If the proper font is not set as the default font on the printer, then this font must be set again after the printer is reset or turned off/on.

---



### 2.2.3 Header in the Line Layout

For each line layout, you can define an individual header.  
The number of headers can be between 0 and 10. The contents can be any given text.

#### How to Set the Number of Headers:

1. In the header area, click on the "Number of Lines" box.
2. Enter a valid value (0 to 10).

or

Use the spin box to select the desired value.

#### How to Set the Contents of the Header:

1. In the "Header" area, click on the edit box.
2. Enter the text for the header.

---

#### Note:

The number of headers output corresponds exactly to the number of lines that you set.

---

### 2.2.4 Table in the Line Layout

For each line layout, you can define a table for the output of the messages and measurement values.

Define the number and the contents of the individual columns by means of the "Selection" button. The number of columns can be between 1 and 40 and is dependent on the number of selected message blocks.

#### How to Set the Contents and the Number of the Columns:

1. In the table, click on the "Selection" button. The dialog for selecting the message blocks opens.

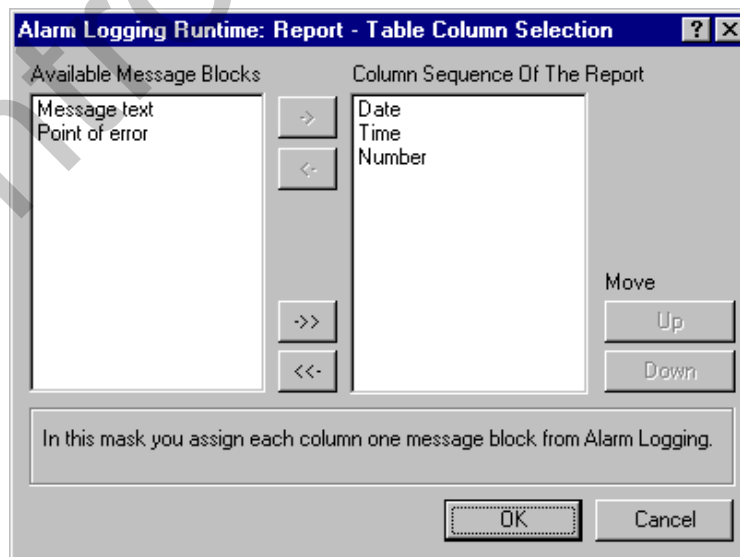

2. Select the desired message blocks from the list of available message blocks and transfer them individually or in groups to the Column Sequence of the Report window using the appropriate buttons in the dialog.

---

**Note:**

Message blocks that were already transferred to the current column sequence list are missing from the list of available message blocks.

The number of columns in the table is adjusted automatically.

---

## 2.2.5 Footer in the Line Layout

For each line layout, you can define an individual footer.

The number of footers can be between 0 and 10. The contents can be any given text.

**How to Set the Number of Footers:**

1. In the footer area, click on the "Number of Lines" box.
2. Enter a valid value (0 to 10).

or

Use the spin box to select the desired value.

**How to Set the Contents of the Footer:**

1. In the "Footer" area, click on the edit box.
2. Enter the text for the footer.

---

**Note:**

The number of footers output corresponds exactly to the number of lines that you set.

---

## 2.3 Output of the Reports

You can output the print layout (page and line layout) you created in Report Designer for the reports by means of the Print Job editor in the WinCC Explorer.

You can find an extensive description of the editors for the print output in the "Editors for Print Jobs" chapter.

There are different output media available for the output.

WinCC offers an integrated report system with which you can create reports about user data, current and archived process values, current and archived messages, and your own system documentation.

### The Report Designer Offers the Following Features:

- Convenient and simple user interface with tool and graphic palettes
- Support of different reporting methods
- Support of the output media supported by Windows
- Page-by-page display of reports that are already archived
- Support of the OLE 2.0 interface
- A 32-bit application that can run under Windows NT
- Standard system layouts and print jobs
- Its own on-line help for Layout and for Line printer layout

---

### Note:

In the data window in the WinCC Explorer, the system layouts and system print jobs of the Report Designer are identified by the "@" symbol.

The system layouts and system print jobs can be edited.

---

### 2.3.1 Layouts in the Report Designer

The Report Designer enables you to release a report when certain events occur. You can create the layout of this report yourself. You can assign the layout you create to a print job.

#### The Following Report Layouts Are Available:

- Page Layout
- Line Layout



This picture shows you the structure of the "Report Designer" in the project navigation window.

#### Creating a Layout

The following steps are necessary for creating a new "Layout" or "Line printer layout".

##### How to Create a New Layout:

1. In the project navigation window, select the "Report Designer" editor and open its pop-up menu.
2. The pop-up menu contains the following functions: "New layout", "New line printer layout", "New print job", "Find..." and "Properties".
3. In the pop-up menu, click on the "New layout" or "New line printer layout" function.
4. In the data window, the file "NewRPLnn.RPL" is loaded under the "Layout" project component  
or  
The file "NewRP1nn.RP1" is loaded under the "Line printer layout" project component. The files are sequentially numbered "nn" (number range between 0 and 99).
6. You can then open the new layout by double-clicking on it. This action starts the Report Designer with the selected layout and you can edit the layout.

## Opening a Layout

The following steps are necessary for opening an existing "Layout" or "Line printer layout".

### How to Open an Existing Layout:

1. In the Project Navigation Window, click on the "Report Designer" editor.
2. Double-click on the "Report Designer" editor to view the installed "Layout," "Line printer layout," and "Print job" sub-items.
3. Click on the "Layout" or "Line printer layout" sub-item. The data window then displays all of the available layouts.
4. In the data window, select the desired layout and click the right mouse button.
5. In the pop-up menu that appears, select the "Open layout" or "Open line printer layout" menu item.
6. This selection starts the "Report Designer" with the selected layout. You can edit the layout.

## Renaming a Layout

The following steps are necessary for renaming an existing "Layout" or "Line printer layout".

### How To Rename an Existing Layout:

1. In the Project Navigation Window, click on the "Report Designer" editor.
2. Double-click on the "Report Designer" editor to view the installed "Layout," "Line printer layout," and "Print job" sub-items.
3. Click on the "Layout" or "Line printer layout" sub-item. The data window then displays all of the available layouts.
4. In the data window, select the desired layout and click the right mouse button.
5. In the pop-up menu that appears, select the "Rename layout" or "Rename line printer layout" menu item.
6. This selection opens the "New Name:" dialog.
7. Change the name of the selected layout and use the "OK" button. The new name is then applied to the selected layout.

## Deleting a Layout

The following steps are necessary for deleting an existing "Layout" or "Line printer layout".

### How to Delete an Existing Layout:

1. In the Project Navigation Window, click on the "Report Designer" editor.
2. Double-click on the "Report Designer" project component to view the installed "Layout," "Line printer layout," and "Print Job" sub-items.
3. Click on the "Layout" or "Line printer layout" sub-item. The data window then displays all of the available layouts.
4. In the data window, select the desired layout and click the right mouse button.

5. In the pop-up menu that appears, select the "Delete layout" or "Delete line printer layout" menu item.
6. The selected layout is then deleted.

---

**Note:**

When you select the "Delete Layout" or "Delete Line Layout" menu item, the selected layout is deleted immediately.

---

### Layout Properties

The following steps are necessary for viewing the properties of an existing "Layout" or "Line printer layout".

#### How to View the Properties of a Layout:

1. In the Project Navigation Window, click on the "Report Designer" editor.
2. Double-click on the "Report Designer" editor to view the installed "Layout," "Line printer layout," and "Print job" sub-items.
3. Click on the "Layout" or "Line printer layout" sub-item. The data window then displays all of the available layouts.
4. In the data window, select the desired layout and click the right mouse button.
5. In the pop-up menu that then appears, select the "Properties" menu item.
6. This selection opens a dialog with the data about when the layout was created and when the last change was made. You can also see a page preview of the selected layout. Use the "OK" button to close the dialog box.

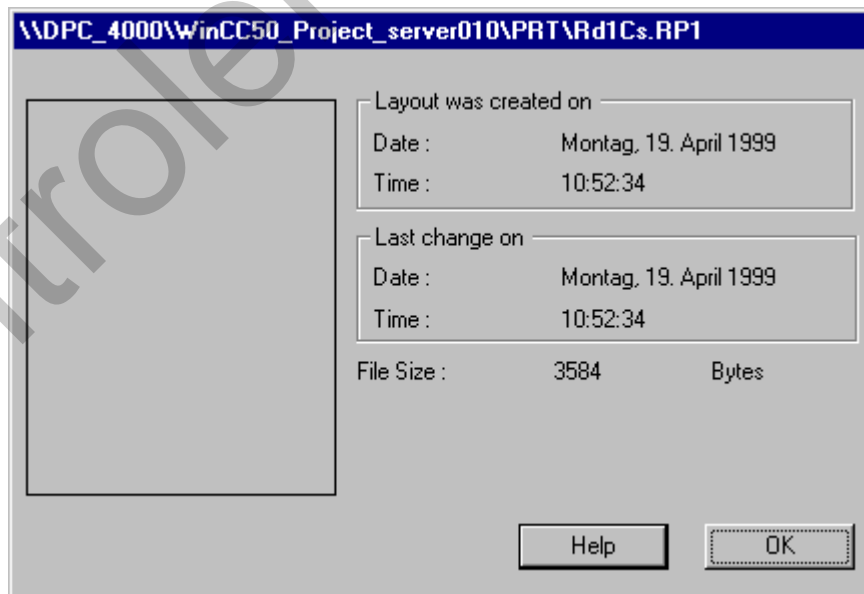

### 2.3.2 Print Jobs in the Report Designer

The Report Designer enables you to output print jobs with a specific layout. You can create the layout for this report yourself.

You can select and process print jobs in the project navigation window under the node "Report Designer".



**Note:**

When you have created a print job, the "Parameter" column in the data window identifies the output location of the report by means of the abbreviations (F), (F,P) or (P). (F) means output to a file and (P) means output to a printer. If (F,P) is displayed, the output goes to a file and to a printer.

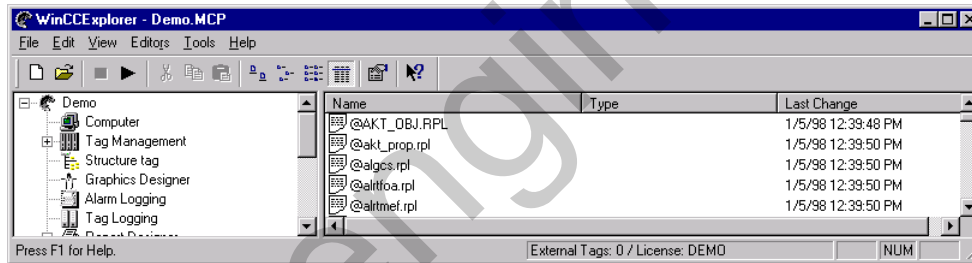

In this example, the print job is output to a file and a printer.

#### Creating a Print Job

The following steps are necessary for creating a new print job.

**How to Create a New Print Job:**

1. In the Project Navigation Window, click on the "Report Designer" editor.
2. Double-click on the "Report Designer" editor to view the installed "Layout," "Line printer layout," and "Print job" sub-items.
3. Click the right mouse button on the "Print Job" sub-item.
4. In the pop-up menu that then appears, select the "New print job" menu item.
5. This selection opens the "Properties" dialog box where you can create a new print job.

## Previewing a Print Job

The following steps are necessary for activating a print preview of a print job.

### How to Activate a Print Preview of a Print Job:

1. In the Project Navigation Window, click on the "Report Designer" editor.
2. Double-click on the "Report Designer" project component to view the installed "Layout," "Line printer layout," and "Print Job" sub-items.
3. Click on the "Print Job" sub-item to view a list in the data window of all of the available print jobs.
4. In the data window, select the desired print job and click the right mouse button.
5. In the pop-up menu that appears, select the "Preview print job" menu item.
6. This selection opens a dialog box. The name of the selected layout is displayed in the title bar of the dialog box. A preview of the print job is also displayed in this box. Use the "Print" button to print the selected print job immediately. Use the "Close" button to end the print preview. Use the other buttons to zoom the preview or select another page.

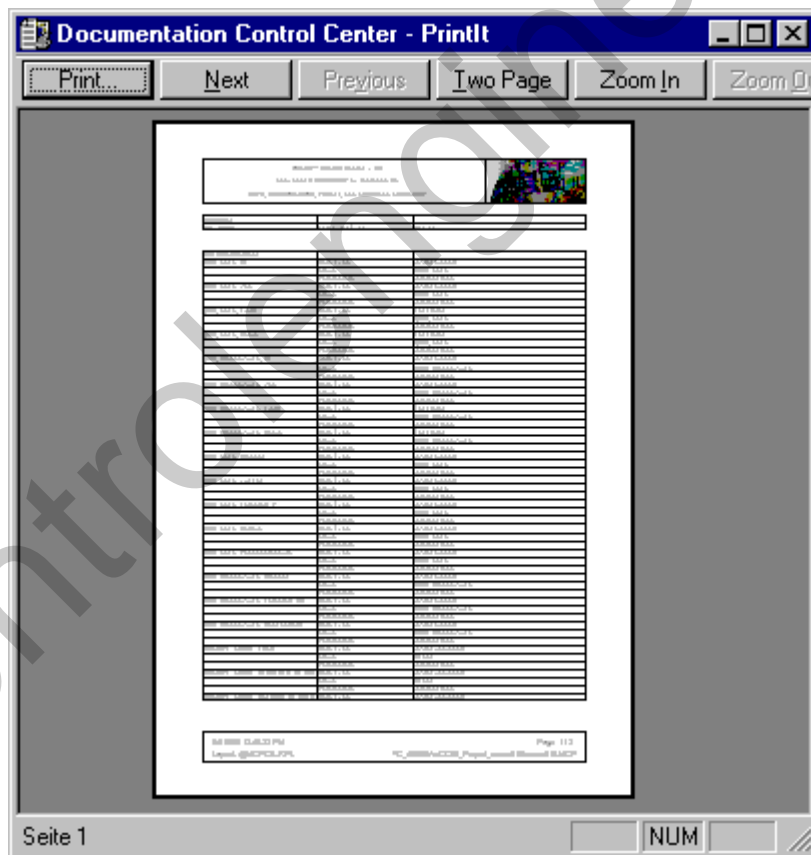

This example shows you the print data preview.



## Printing a Print Job

The following steps are necessary for printing out a print job.

### How to Print a Print Job:

1. In the Project Navigation Window, click on the "Report Designer" editor.
2. Double-click on the "Report Designer" project component to view the installed "Layout," "Line printer layout," and "Print Job" sub-items.
3. Click on the "Print Job" sub-item to view a list in the data window of all of the available print jobs.
4. In the data window, select the desired print job and click the right mouse button.
5. In the pop-up menu that then appears, select the "Print the print job" menu item.
6. The selected print job is printed.

---

### Note:

Use the "Documentation WinCC Explorer" dialog to cancel the current print job or to view the current status of the print job. If you want to interrupt the current print job, use the "Cancel" button.

---

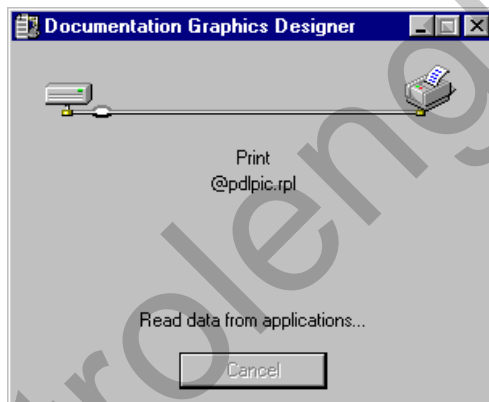

## Print Job Properties

The following steps are necessary for editing the properties of an existing print job.

### How to Edit the Properties of a Print Job:

1. In the Project Navigation Window, click on the "Report Designer" editor.
2. Double-click on the "Report Designer" editor to view the installed "Layout," "Line printer layout," and "Print job" sub-items.
3. Click on the "Print Job" sub-item to view a list in the data window of all of the available print jobs.
4. In the data window, select the desired print job and click the right mouse button.
5. In the pop-up menu that then appears, select the "Properties" menu item.
6. This selection opens the "Properties" dialog box. Use this dialog box to edit all of the settings that affect the selected print job.

### 2.3.3 "Properties" Dialog for Print Jobs

In the WinCC Explorer, each configured print job has a "Properties" dialog box. You can use this dialog box to assign special settings to each print job. The box contains the following three tabs:

Tab	Contents
Print Job	You can enter general data about the print job in this tab.
Selection	You can enter data about the page range and the time range of the print data in this tab.
Printer Setup	Use this tab to set the output unit for the print job. You can also send the print job to a file.

#### "Print Job" Tab

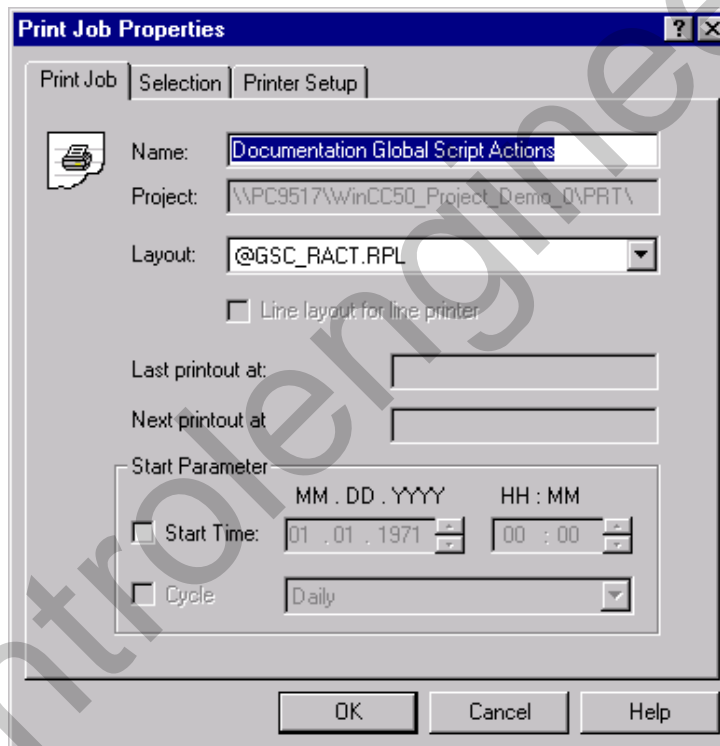

This example shows you the "Print Job" tab.

Box Name	Meaning
Name	Enter the name of the print job here. The name must be unique within a project and must conform to Windows conventions.
Project	The project name with a complete path for the print job is displayed here. You cannot edit this box.
Layout	Assign a report layout to the print job here. The layout must be available already. If you have not entered a layout in this area and if you attempt to open one of the other tabs, the "PRTRTAPI" dialog box appears. This dialog box notifies you that you are working with a system print job to which a layout must be assigned.
Line layout for line printer	Use this selection button to send all of the reports as line layouts to a line printer. You must input a previously configured line layout (<Filename>.RP1) in the "Layout" box. All of the values in the "Start Parameter" area are displayed in gray and are therefore not available. In the tab, the icon changes accordingly. <b>Note:</b> This check box is enabled only for the system print job "@Report Alarm Logging RT Message sequence".
Last printout at	The date of the last printout of this print job is displayed here. You cannot edit this box; it only describes a status.
Next printout at	The date of the next printout of this print job is displayed here. You cannot edit this box; it only describes a status.
Start Parameter: Start Time	Set the start time and date of the print job.
Start Parameter: Cycle	You can set the cyclic startup of the print job here. Before doing so, you must set the starting time and the date of the print job. The following options are available to you as the cyclic range: <NONE> Hourly Daily Weekly Monthly
Start Parameter: Event	Set startup of the print job dependent on an event.

**Note:**



You see this icon in the WinCC Explorer data window when you activate "Start Time".



You see this icon in the WinCC Explorer data window when you activate "Start Time" and "Cycle".

### "Selection" Tab

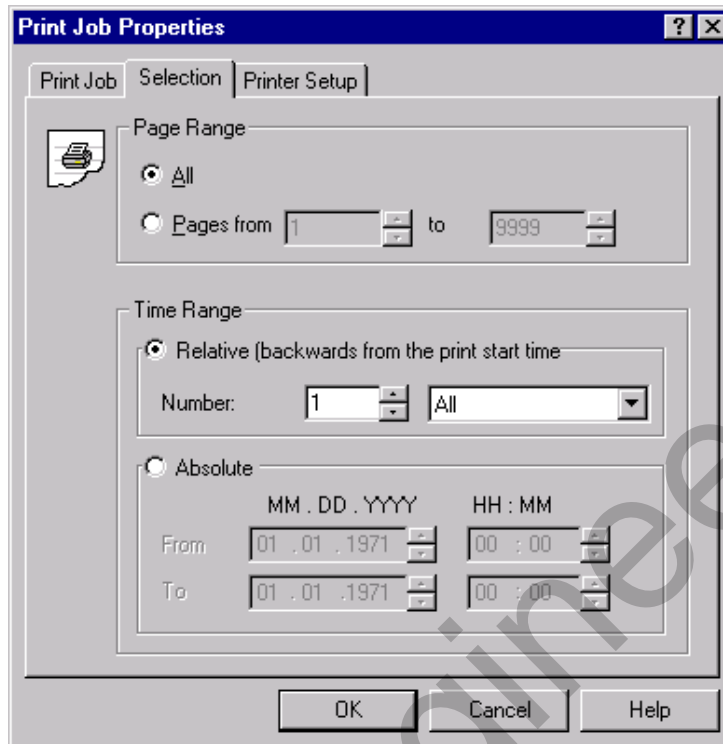

This example shows you the "Selection" tab.

Box Name	Meaning
Page Range All	All of the pages of the print job are printed.
Pages from nnn to nnn	Set the print job to print out individual pages or a page range.
Time Range Relative (back from start time)	Use this option button to define a relative time range going back from the start time. The following possibilities are available for a relative time range:
	All
	Years
	Months
	Weeks
	Minute
	Days
	Hour
Number	Here you can set the size of the time range. Numerical values between 1 and 100 are possible.
Time Range Absolute	Click on this option button to define an absolute time range going back from the print start time.
From nnn To nnn	Set the time range and date for the print job.

**"Printer Setup" Tab**

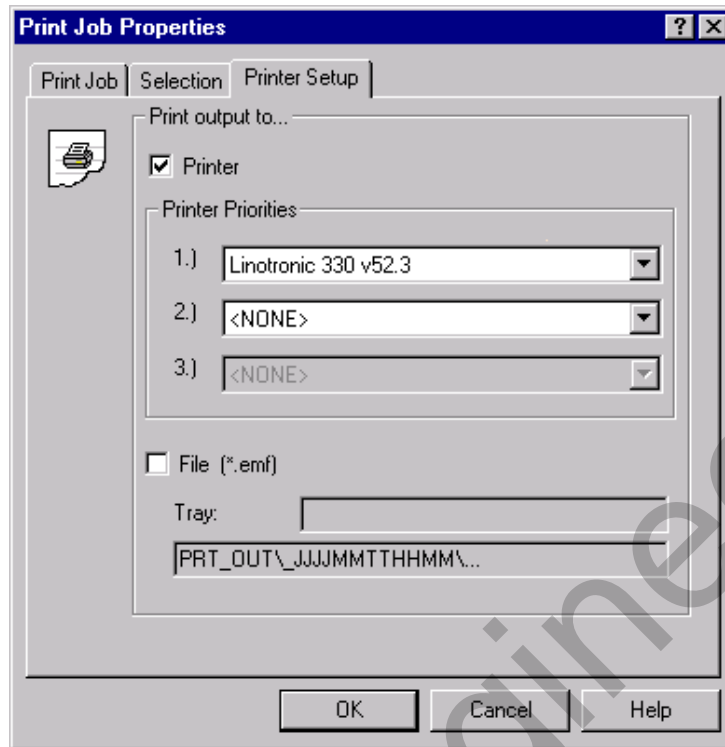

This example shows you the "Printer Setup" tab.

Box Name	Meaning
Print output to...	
Printer	When you click on this check box to activate it, the "Printer Priorities" boxes are enabled and you can set the printer you want to use.
Printer Priorities	
1.)	Enter the first printer here. The system always attempts to access this printer. If this printer is not ready, the second printer provided is activated.
	Note: If you activated the "Line layout for line printer" check box in the "Print Job" tab, you can enter the desired parallel interface in this box (for example, LPT1). Boxes 2 and 3 within the printer priorities are deactivated.
2.)	Enter the second printer here. The system always attempts to access this printer if the first printer is not ready. If this printer is not ready either, the third printer provided is activated.
3.)	Enter the third printer here. The system always attempts to access this printer if the first and second printers are not ready.

Box Name	Meaning
File (*.emf)	If you click on this check box to activate it, the print jobs which occur are sent to a file. In the "Tray" box, enter the name of the path to which the file is to be stored. The name of the path is made up of the following components: of the project path (e.g. "C:\VFSWinCC\PRT\") and <Tray> + <YYYYMMDDHHMM> (YYYY = Year, MM = Month, DD = Day, HH = Hour, MM = Minute).

**Note:**

If you assign, for example, "Pdata" in the "Tray" box, WinCC will set up the following path structure within the project directory for the print job.

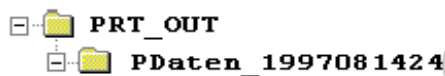

You would find one or more files named "Page<nnn>.emf" (<nnn> being sequential numbers) in this folder. If you do not make any entries in the "Archive" box, WinCC loads the path <YYYYMMDDHHMM>. You cannot enter a back slash (\) in the "Tray" box to set additional sub-paths.

If the printer malfunctions during a cyclic report, WinCC might halt.

Remedy: Deactivate the setting "Store Print Jobs in Clipboard" in Windows (e.g. in "Win95\Control Panel\Printer\Details\Connection Settings").

### 2.3.4 Deleting an Existing Print Job in the Report Designer

The following steps are necessary for deleting a new print job.

1. In the Project Navigation Window, click on the "Report Designer" editor.
2. Double-click on the "Report Designer" editor to view the installed "Layout," "Line printer layout," and "Print job" sub-items.
3. Click on the "Print Job" sub-item to view a list in the data window of all of the available print jobs.
4. In the data window, select the desired print job and click the right mouse button.
5. In the pop-up menu that then appears, select the "Delete print job" menu item.
6. This selection opens a dialog box. This box contains the name of the selected print job and asks if you want to delete it. Use the "Yes" button to delete the selected print job.

## 2.4 System Layouts and Print Jobs of WinCC

The release of WinCC includes system layouts and system print jobs. You can use these system layouts to create reports immediately and without changing them. You can also use these system files as templates to create your own layouts and print jobs.

The release includes page layouts for the following tasks:

- Project documentation of configured data and
- Creating reports with data from run time

The "Name" column contains a list of the print jobs. The "Parameters" column contains the corresponding system layouts.

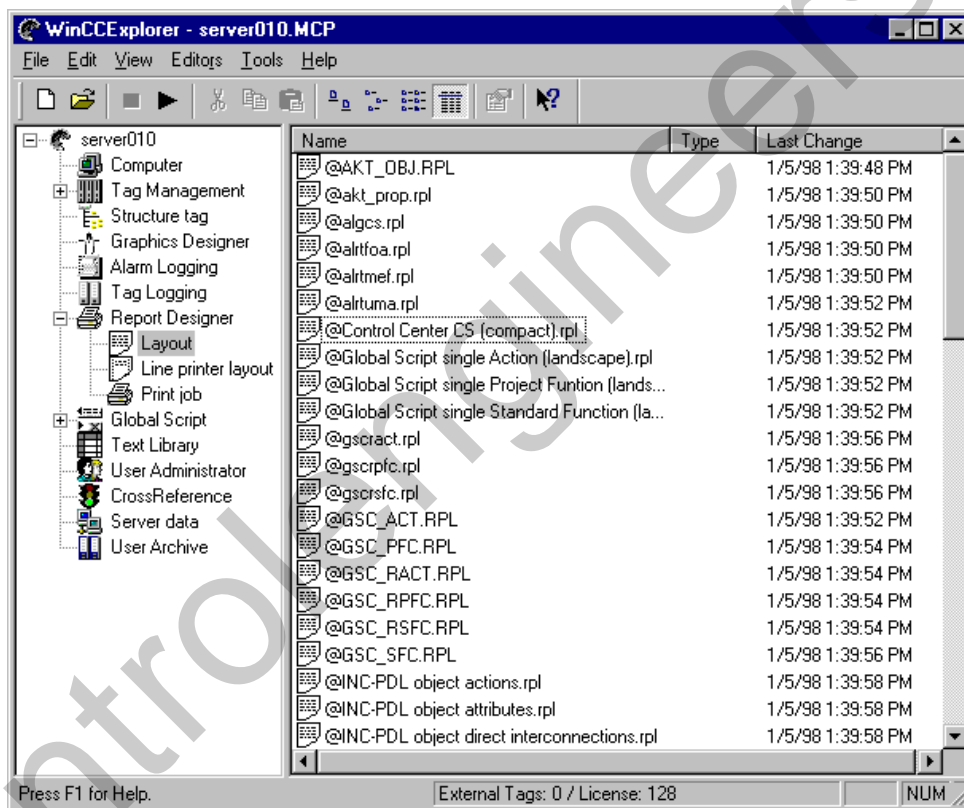

The system files are in the WinCC directory in the "..\WinCC\syslay" folder and are copied to the "..\<Projectname>\Prt" folder of the appropriate project directory when a new project is loaded.

### Note:

These system layouts and system print jobs are loaded for every newly loaded project.

When the report output is started by the applications (for example, project documentation in the Graphics Designer) these system jobs are used. For this reason, you cannot delete or rename the system layouts or the system print jobs.

## 2.4.1 System Layouts for the Project Documentation

WinCC provides you with a number of system layouts that are rigidly linked to print jobs and are used for project documentation.

Name of the print job	Name of the layout
@Documentation Alarm Logging	@AlgCS.RPL (P)
@Documentation Control Center	@MCPCS.RPL (P)
@Documentation Global Script Actions	@GSC_RACT:RPL (P)
@Documentation Global Script Projekt function	@GSC_RPFC.RPL (P)
@Documentation Global Script Standard function	@GSC_RSFC.RPL (P)
@Documentation Graphics Designer	@pdlpic.RPL (P)
@Documentation Lifebeat Monitoring	@LBMCS.RPL (P)
@Documentation Picture Tree Manager	@PTMCS.RPL (P)
@Documentation Signal Collection	@SCollect.RPL (P)
@Documentation Storage	@storcfg.RPL (P)
@Documentation Tag Logging	@TlgCS.RPL (P)
@Documentation Text Library	@Textlibrary.RPL (P)
@Documentation User Administrator	@UACS.RPL (P)
@Internal Global Script Actions	@gsc_act.RPL (P)
@Internal Global Script Project-function	@gsc_pfc.RPL (P)
@Internal Global Script Standard-function	@gsc_sfc.RPL (P)
@Internal Graphics Designer Actions at the object	@akt_obj.RPL (P)
@Internal Graphics Designer Actions at the property	@akt_prop.RPL (P)

You can start the project documentation in the WinCC Explorer by starting the appropriate print job or by starting the project documentation directly in the application.

---

### Note:

For the project documentation, you can create your own page layout and call it up in the system print job. This gives you the opportunity to format the project documentation in any way you want.

---



## 2.4.2 System Layouts for On-Line Reporting

WinCC provides you with a number of system layouts that are rigidly linked to print jobs and are used for reporting runtime data.

Name of the print job	Name of the layout
@Protokoll Tag Logging RT Tabellen	@tlrftab.rpl
@Protokoll Tag Logging RT Kurven	@tlrtkur.rpl
@Protokoll Storage RT Datenträger	@StorCRT.RPL
@Protokoll Storage RT	@StorART.RPL
@Protokoll Alarm Logging RT Umlaufarchiv	@altruma.rpl
@Protokoll Alarm Logging RT Meldefolge	@alrtmef.rpl
@Protokoll Alarm Logging RT Folgearchiv	@alrtfoa.rpl

### Note

The system print jobs included in the release of WinCC may not be deleted or renamed. These system print jobs are connected to the applications permanently.

## 2.4.3 Print Jobs in the Release

WinCC provides you with a number of system layouts that are rigidly linked to print jobs and are used for outputting the reports.

Name of the print job	Name of the layout
@Report Alarm Logging RT Message sequence	@AIRtMeF.RPL (P)
@Report Alarm Logging RT Sequence archive	@ALRtFoA.RPL (P)
@Report Alarm Logging RT Revolving archive	@ALRtUmA.RPL (P)
@Report Tag Logging RT Curves	@TIRtKur.RPL (P)
@Report Tag Logging RT Tables	@TIRtTab.RPL (P)
@Documentation Alarm Logging	@AlgCS.RPL (P)
@Documentation Tag Logging	@TlgCS.RPL (P)
@internal Global Script Actions	@gsc_act.RPL (P)
@internal Global Script Standart-function	@gsc_sfc.RPL (P)
@internal Global Script Project-function	@gsc_pfc.RPL (P)
@internal Graphics Designer Actions at the property	@akt_prop.RPL (P)
@internal Graphics Designer Actions at the object	@akt_obj.RPL (P)
@Documentation Graphics Designer	@pdlpic.RPL (P)
@Documentation Control Center	@MCPCS.RPL (P)
@Documentation Global Script Actions	@GSC_RACT.RPL (P)
@Documentation Storage	@storcfg.RPL (P)

Name of the print job	Name of the layout
@Documentation Global Script Standart function	@GSC_RSFC.RPL (P)
@Documentation Global Script Project function	@GSC_RPFC.RPL (P)
@Documentation User Administration	@UACS.RPL (P)
@Documentation Text Library	@Textlibrary.RPL (P)
@Documentation Picture Tree Manager	@PTMCS.RPL (P)
@Documentation Lifebeat Monitoring	@LBMCS.RPL (P)
@Report Storage RT	@StorART.RPL (P)
@Report Storage RT Data Carrier	@StorCRT.RPL (P)
@Documentation Signal Collection	@SCollect.RPL (P)

Column	Meaning
Name	Name of the print job
Type	Type of the print job
Parameter	Name of the print job and in () the output medium specification
F	Output to a file
P	Output to a printer
F,P	Output to a file and a printer

**Note:**

The system print jobs included in the release of WinCC may not be deleted or renamed. These system print jobs are connected to the applications permanently.

controlengineers.ir

## 3 Editors

Report Designer offers you three high capacity editors for the definition and output of the reports.

You can find the following editors in the WinCC Explorer:



- For the creation of reports:
  - An editor for page layouts
  - An editor for line layouts
- For the output of reports:
  - An editor for print jobs

### 3.1 Editor for Page Layouts

The structure and control of the editor is, whenever its requirements allow, the same as that of the Graphics Designer. For you as the user, this represents further simplification in your use of WinCC.

The editor for page layouts contains the following items:

- Palettes for creating and editing objects:
  - Color Palette
  - Object Palette
  - Style Palette
  - Alignment Palette
  - Zoom Palette
- Bars for operating the editor:
  - Menu Bar
  - Standard Palette
  - Font Palette
  - Status Bar
- Boxes for setting and changing the object properties:
  - Properties

For the optical setup of the page layout, the editor provides you static objects and system objects. It also provides dynamic objects for setting up the data output.

### 3.1.1 General Information about the Editor

#### Changing the Palette Size

In order to have a better overview of the entries in the palettes, especially those in the object and style palettes, you can change the size of the palettes.

##### How to Change the Size of the Palettes:

1. Click on the palette border, hold down the left mouse button, and drag the palette into the workspace.

The palette receives a blue title bar with the "Close" icon.

2. Drag the palette to the desired size as you do with other Windows objects.
3. While holding down the left mouse button, move the palette to wherever you want it on the screen.

### 3.1.2 Color Palette

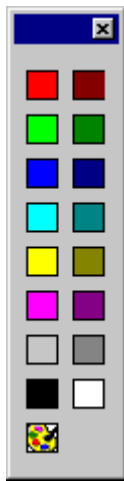

Through the color palette, you can assign one of the 16 standard colors, a basic color, or a color you define yourself to the selected objects by using the mouse.

For example, a mouse click within the color palette changes any of the following colors:

- The fill color for area objects (for example, rectangles)
- The background color for text objects.

---

**Note:**

The color palette does not affect line objects.

---

### 3.1.2.1 Assigning a Standard Color

**How to Assign a Standard Color to an Object:**

1. Click on the object.
2. Click on one of the 16 standard colors in the color palette.

### 3.1.2.2 Assigning a User-Defined Color

**How to Assign a Color You Define Yourself to an Object:**

1. Click on the object.
2. Click on the  icon in the color palette.
3. Click on the color you want in the "Basic Colors" or the user-defined colors.

or

Click on the "Define Color" button to create another color combination.

### 3.1.3 Object Palette

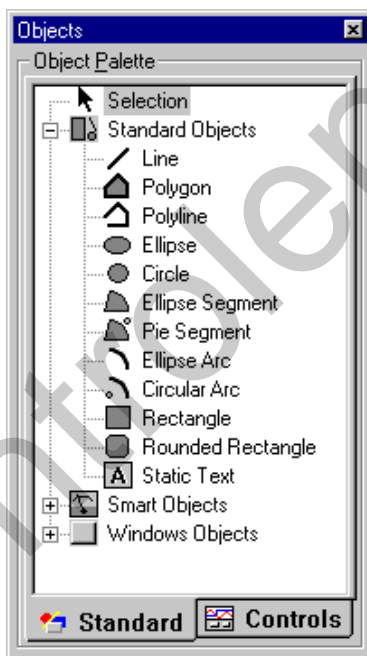















Use the object palette to select an object to be inserted in the page layout of the report. The objects available in the editor for page layouts are arranged by the following subject areas:

- Static objects such as polygon, ellipse, and rectangle
- Dynamic objects such as dynamic table and dynamic text
- System objects such as date/time and page number

### 3.1.4 Static objects

#### Static objects

You can insert static objects both in the static part and in the dynamic part of the report page layout. Static objects are used merely for the visual design of a report.

Object	Description
	Line
	Polygon
	Polyline
	Ellipse
	Circle
	Ellipse Segment
	Pie Segment
	Ellipse Arc
	Circular Arc
	Rectangle
	Rounded Rectangle
	Static Text
	OLE Object The editor for page layouts of Report Designer features the option of including OLE elements in a report.
	Static Metafile With the "Static Metafile" object type, you can insert the graphics files in the static section of a layout. The graphics files must be available in *.emf (enhanced meta file) format.





### 3.1.5 Dynamic objects

You can insert dynamic objects only in the dynamic section of a page layout. You use dynamic objects to set the data types (trends and tables) which you want to read out to the report.

In creating the page layout, you have to link the dynamic objects to the corresponding applications.

The data are taken for output of the report at the time of output from the linked application.





You set the appearance and position of the object at the time you create the page layout. However, the size of the object (downward expansion) depends on the data which are not extracted from the data object of the linked application until the report is printed. All the following dynamic objects are moved downwards accordingly.

Object	Description
	<p>Dynamic Metafile</p> <p>With the "Dynamic Metafile" object type, you can insert graphics from other applications - for example, trends from Tag Logging - in the dynamic section of the report page layout.</p>
	<p>Inserting a Dynamic Table</p> <p>With the "Dynamic Table" object type, you can insert data from other applications - for example, tables from Tag Logging and archives from Alarm Logging - in the dynamic section of the report page layout.</p>
	<p>Dynamic Text</p> <p>With the "Dynamic Text" object type, you can insert text from other applications - for example, tags or connections - in the dynamic section of the report page layout.</p>
	<p>Inserting an Inserted Layout</p> <p>With the "Inserted Layout" object type, you can insert an existing page layout in another page layout. This enables nesting of the reports.</p>
	<p>Inserting a Tag</p> <p>With the "Tag" object type, you can read out the tag name in the configuration system (CS) or the tag value during runtime. Tag values can be read out only if the project has been activated, of course.</p>



### 3.1.6 System objects

You can insert system objects only in the static section of a page layout. The requisite details for formatting system objects are described at Attribute Format. If you do not wish to set a format, a default format is used for all system objects at the time the report is output.

Object	Description
	<p>Date/Time</p> <p>With the "Date/Time" system object, you insert a token value for the date and time and for the time of printing the report in the page layout. The system date and the system time are inserted during printing.</p>
	<p>Page Number</p> <p>With the "Page Number" system object, you insert a token value for the current page number of the report in the page layout.</p>
	<p>Project Name</p> <p>With the "Project Name" system object, you insert a token value for the project name in the report page layout.</p>
	<p>Layout Name</p> <p>With the "Layout Name" system object, you insert a token value for the layout name in the report page layout.</p>

#### 3.1.6.1 Drawing an Object

##### Before you begin

All objects are drawn with the previously set object properties. You can change all of these presettings (see "Changing Object Properties").

##### How to Draw an Object:

1. Select the desired object by using the mouse in the object palette.
2. Move the mouse to the workspace. The mouse pointer changes to a mouse pointer with an attached object icon.
3. Drag the mouse pointer while pressing the mouse button until the object reaches the desired size.

or

Click on the workspace. The object is then displayed in a size that is predefined by the system.

### How to Insert a Polygon or a Polyline:

1. Select the "Polygon" or "Polyline" icon in the object palette.
2. Move the mouse to the workspace. The mouse pointer changes to a mouse pointer with an attached object icon.
3. Click the left mouse button on the desired starting point.
4. Click the left mouse button on each additional corner you want for the polygon.
5. **End** the polygon or polyline by **double clicking** the left mouse button or clicking the right mouse button. The polygon is closed while the polyline is not.

---

#### Note:

The area on which you end the creation of the polygon or polyline is not applied.

---

### After Drawing

After you draw an object, you have the following two possibilities:

The object remains selected and you can change its properties

or

You can draw additional objects of the same type. Reset the mouse button by selecting "Selection."

You can set this behavior by means of the "Options" - "Settings..." menu in the "Options" tab. Select the "Always Reset Object Type Selection" in the "Object Tree".

### 3.1.6.2 Selecting an Object

#### How to Select an Object:

- Click on an object with the mouse.

#### How to Select Multiple Objects:

- Hold down the "Shift" key and click on each object with the mouse.

or

Hold down the mouse button and drag a frame ("lasso") around the objects you want to select.

---

#### Note:

If you used the "Options" - "Settings..." menu to choose the "Touching" option under "Object Selection" in the "Options" tab, you can mark the objects you want by simply touching them with the lasso.

---

With the "Surrounding" option, all of the objects to be marked must be completely enclosed by the lasso.

### 3.1.6.3 Changing Object Properties

#### How to Change Object Properties in Individual Objects:

1. Click on an object with the mouse.
2. Click the right mouse button to open the pop-up menu.
3. Click on "Properties..." to open the "Properties" dialog window.
4. Select the appropriate attribute to change the object property.

#### How to Change Object Properties in a Multiple Selection:

1. Hold down the "Shift" key and click on each object with the mouse.  
or  
Hold down the mouse button and drag a frame ("lasso") around the objects you want.
2. Click the right mouse button to open the pop-up menu.
3. Click on "Properties..." to open the "Properties" dialog window.
4. Select the appropriate attribute to change the object property for the selected objects.

---

#### Note:

All of the attributes of the selected objects are displayed. If there is no value in the static column, the objects have different attribute properties. You can make the attribute property for all of the selected objects the same by entering a value.

---

### Presetting the Object Properties

You can specify a presetting (default setting) for each object type. These presettings are used each time a new object is loaded.

#### How to Set the Defaults for Object Properties:

1. Select an object in the object palette.
2. Open the "Properties" dialog window and attach it to the screen with the Pin button. The appropriate default object is displayed in the "Properties" dialog window.
3. Change the object properties.

---

#### Note:

When the "Properties" dialog window is open, you can select additional objects in the object palette to display and change their defaults.

---

### 3.1.6.4 Moving an Object with the Mouse

#### How to Move an Object with the Mouse:

1. Click on an object and hold down the left mouse button.
2. Drag the object to the desired position.

---

#### Note:

If the "Snap to Grid" function is enabled, the object can only be moved according to the grid setting.

---

### 3.1.6.5 Sizing an Object with the Mouse

#### How to Change the Size of an Object with the Mouse:

1. Click the mouse on the object. The object is then surrounded by a rectangle with 8 handles.



for example

2. Click on one of these handles and hold down the left mouse button.
3. Drag the object to the desired size.

You can change the size of the object diagonally with one of the four corner handles. Change the size horizontally or vertically with one of the handles in the middle of the border.

### 3.1.6.6 Changing the Start Angle/End Angle with the Mouse

The "Change the Start and End Angle" function relates to the objects "Pie Segment", "Circular Arc", "Ellipse Segment" and "Ellipse Arc".

#### How to Change the Start/End Angle of an Object with the Mouse:

1. Click the mouse on the object. The object is then surrounded by a rectangle with 8 handles. The end points of the curved object are identified by somewhat larger handles.



2. Click on one of the larger handles and hold down the mouse button.
3. Drag the object to the desired size.

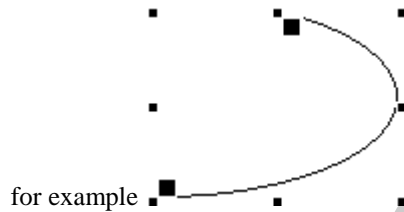

You can change the size of the object diagonally with one of the four corner handles. Change the size horizontally or vertically with one of the handles in the middle of the border.

### 3.1.7 Style Palette





Change the look of the selected object using the style palette. Depending on the object type, there are different types of styles available. For example:

- different Line Styles
- several Line Weights
- various Fill Patterns.

### 3.1.7.1 Changing the Line Style

The look of lines can be altered by changing the line properties. There are different styles available, like dot, dash, and solid. You can select the style of line from the style palette.

#### How to Change the Line Style Using the Style Palette:

1. Click on an object with the mouse.
2. Click on the  icon in the style palette.  
or  
Click on the  in front of your selection to open it.
3. Click on the line style you want to use from the selection available.

---

#### Note:

If you select the line style "dash", "dot", "dash dot", or "dash dot dot," a weight of approx. 1 pixel is displayed and a weight of 1 point is printed out regardless of the selected line weight (point does not equal pixel).



---

### 3.1.7.2 Changing the Line Weight

Lines can be represented in various weights (i.e. widths). You can select the weight of line from the style palette.

The values provided correspond to a weight measured in points (pt).

#### How to Change the Line Weight Using the Style Palette:

1. Click on an object with the mouse.
2. Double click on the  icon in the style palette.  
or  
Click on the  in front of your selection to open it.
3. Click on the weight you want to use from the selection available.

---

#### Note:



The weight can only be increased for the "solid" and "transparent" line styles. A line weight of 1 pixel is always displayed and a weight of 1 point is always printed out for all other line styles even if you select a larger line weight (point does not equal pixel).

---

### 3.1.7.3 Changing the Fill Pattern

The look of the background areas of objects can be altered by changing the object properties. There are different fill patterns available, like solid, striped, and transparent. You can select the fill pattern from the style palette.

#### How to Change the Fill Pattern Using the Style Palette:











1. Click on the area object.
2. Click on the  icon in the style palette.  
or  
Click on the  in front of your selection to open it.
3. Click on the fill pattern you want to use from the selection available.

### 3.1.8 Alignment Palette

With the alignment palette, you can perform any of the following actions:

- Change the absolute location of one or more objects.
- Change the location of the selected objects relative to each other.
- Unify the height and width of multiple objects.

The following alignment functions are available for the selected objects:

Symbol	Description
	Aligning objects with left side
	Aligning objects with right side
	Aligning objects with top
	Aligning objects with bottom
	Aligning objects centered horizontally
	Aligning objects centered vertically
	Unifying horizontal spacing between objects
	Unifying vertical spacing between objects
	Unifying width of objects
	Unifying height of objects
	Unifying width and height of objects

## Aligning Objects

### How to Align Objects:

1. Select the objects that you want to realign in the workspace.
2. Click on the appropriate icon in the alignment palette.  
The objects are realigned.

### How to Unify the Width/Height of Objects:

1. While holding down the "Shift" key, click on the objects you want to unify in your workspace.
2. Click on the appropriate icon in the alignment palette.  
The objects are all set to the width and/or height of the **largest** object.

## 3.1.9 Zoom Palette



The zoom palette lets you use the mouse in combination with the slider or the buttons to set the zoom factor of the active window. The current zoom factor is displayed below the slider.

You can also set Zoom step-by-step using the standard palette functions.

### How to Set the Zoom Factor:

1. Holding down the left mouse button, drag the slider to the desired zoom factor.
2. The zoom factor (in percent) and the page view are changed according to the movement of the mouse.

or

1. Click above or below the control. The zoom factor is changed by one zoom level according to the position of the mouse.

or

1. Click on one of the selectable buttons. The zoom factor is changed to the zoom level you select.



### 3.1.10 Menu Bar

All of the menu commands available in the Report Designer are divided into groups and assigned to different menus in the menu bar.

To execute a command, open the appropriate menu, click on the command and, if a dialog opens, enter the desired parameters.

Commands that cannot be activated are displayed light gray.

Menu	Menu Command	Shortcut
File	New Open... Close Save Save As... Save All Print... Print Preview Printer Setup... File List Exit	Ctrl + N Ctrl + O  Ctrl + S  Ctrl + P
Edit	Undo Redo Cut Copy Duplicate Paste Delete Select All	Ctrl + Z STRG + A Ctrl + X Ctrl + C  Ctrl + V DEL
View	Properties Toolbars... Grid... Zoom Static Part Dynamic Part Cover Sheet Contents of Report	
Paste		
Arrange Menu	Align	
Tools		
Window	New Window Cascade Tile Vertically Tile Horizontally Arrange Icons Close All Window List	
Help	Contents and Index Direct Help Using Help About Report Designer...	

---

**Note:**

The explanations presented below only refer to those menu commands that will not already be familiar to you from other Windows applications or whose functional scope goes beyond that familiar. Information about these menu commands can be found in the QuickTips for the individual editors.

---

### 3.1.11 File Menu

**Save All**

Save the current version of all open work windows under already existing names with the "Save All" command. If a window has not been named, the system automatically switches to the "Save As ..." dialog.

**Print...**

Print the layout of the open report or parts of it to the preset printer with the "Print..." command.

**Print Preview**

Use the "Print Preview" command to check the page layout in the print view before you print it out.

**Printer Setup...**

Set up the desired printer and its parameters with the "Printer Setup..." command.

### 3.1.12 Edit Menu

**Undo**

Take back the last command used in processing the layout (Undo). A maximum of the last 30 actions can be undone.

**Redo**

Repeats the action that was undone ("Undo") previously.

**Duplicate**

Create a copy of an object directly in the layout. Objects duplicated this way are not stored on the Clipboard.

**Select All**

Highlight all of the objects in the layout.

**Properties**

Transfer the properties of an object or an object group to another object using the "Properties" menu item under the "Edit" menu. You can select from two functions which can also be accessed using the standard palette icons:

- Copy Properties
- Assign Properties

### Copy Properties

Copies the static properties from an object in order to transfer them to another object.

### Assign Properties

After you take properties from one object with the "Properties" - "Copy" command, transfer them to a selected object with the "Properties" - "Assign" command.

## 3.1.13 View Menu

### Toolbars...

Turn the palettes and toolbars on and off depending on your need.

### Grid...

You can insert a grid into the workspace in order to make your work there more precise. If you also switch on the "Snap to Grid" function, all newly drawn objects are automatically aligned with the grid points.

### Zoom

Change the size of the layout shown on the screen with the "Zoom" command. The view can be changed from one-sixteenth (6.25%) to four times its original size (400%) in logarithmic steps.

### Zoom Area

With the "Zoom" - "Zoom Area" command, you can select a segment of the screen with a lasso and enlarge the segment. The maximum enlargement is four times the original (400%).

### Static Part

Use the "Static Part" command to make the static part of a layout active and make the dynamic part inactive. If the static part is already active, it remains active. The static part can be defined individually for the cover sheet, the inside pages, and the final page. The same static part is repeated on all of the inside pages.

### Dynamic Part

Use the "Dynamic Part" command to make the dynamic part of a layout active and make the static part inactive. If the dynamic part is already active, it remains active.

### Cover Sheet

Use the "Cover Sheet" command to make the cover sheet of the layout active and to make the other active section (contents of the layout or final page) inactive. If the cover sheet page type is already active, it remains active.

### Contents of Report

Use the "Contents of Report" command to make the contents of the layout active and to make the other active section (cover sheet or final page) inactive. If the contents of report page type is already active, it remains active.

## Final Page

Use the "Final Page" command to make the final page of the report active and to make the other active section (cover sheet or contents of report) inactive. If the final page type is already active, it remains active.

### 3.1.14 Insert Menu

#### Object

Use the "Object..." command to insert all of the available objects into your active page without using the object palette. The objects are inserted according to their type (static, dynamic, or system objects).

The objects are created and selected by holding down the left mouse button and dragging the mouse. They can be edited by using the mouse directly or by means of the properties dialog box.

### 3.1.15 Arrange Menu

#### Align

Determine the location of objects relative to each other. The functionality corresponds to the alignment palette.

---

#### Note:

More information about aligning objects can be found in the section entitled "Aligning Objects".

---

#### Layer

You can influence the location of an object with the "Layer" command. The following functions are available:

- Place On Top
- Place On Bottom
- Move Up One Layer
- Move Down One Layer

#### Place On Top

Move an object to the foreground within a layer using the "Layer" - "On Top" command.

#### Place On Bottom

Move an object to the background within a layer using the "Layer" - "On Bottom" command.

#### Move Up One Layer

Move an object one position forward by means of the "Layer" - "Up One" command.

#### Move Down One Layer

Move an object one position backward by means of the "Layer" - "Down One" command.

### 3.1.16 Options Menu

#### Settings...

Use the "Settings..." command to make the following settings:

- Grid...
- Options
- Units
- Menu/ Toolbars

#### "Grid" Tab

You can display a grid in the workspace in order to make your work there more precise. If you also switch on the "Snap to Grid" function, all newly drawn objects are automatically aligned with the grid points.

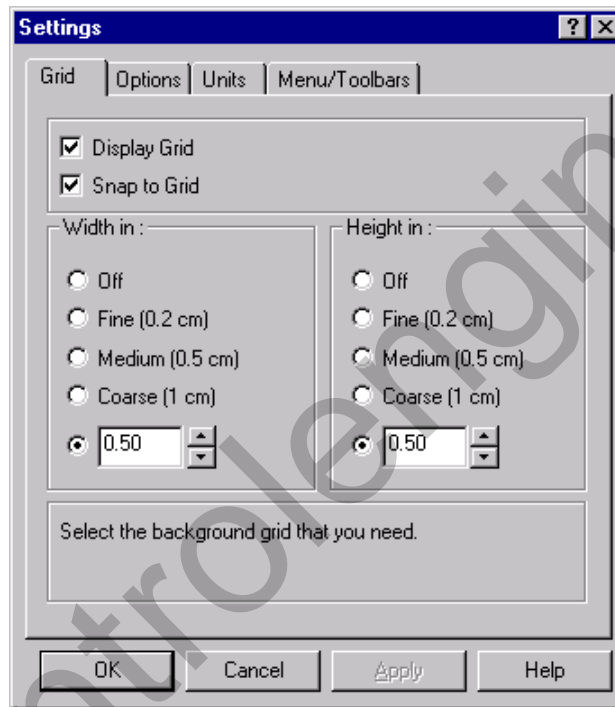

## "Options" Tab

Set the basic program settings by means of the "Options" tab.

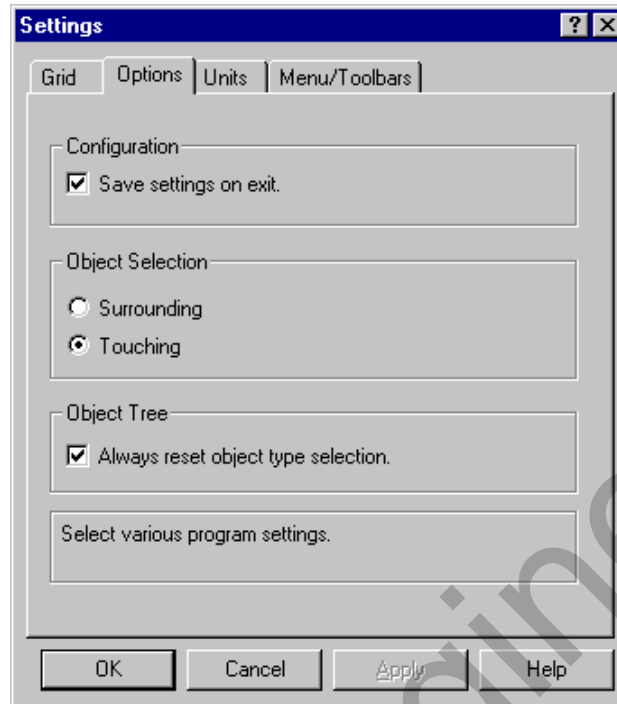

## "Units" Tab

The "Units" tab allows you to set the units inch, centimeter, and point (a special unit of the electronic data processing) for coordinates, text height, and line weight.

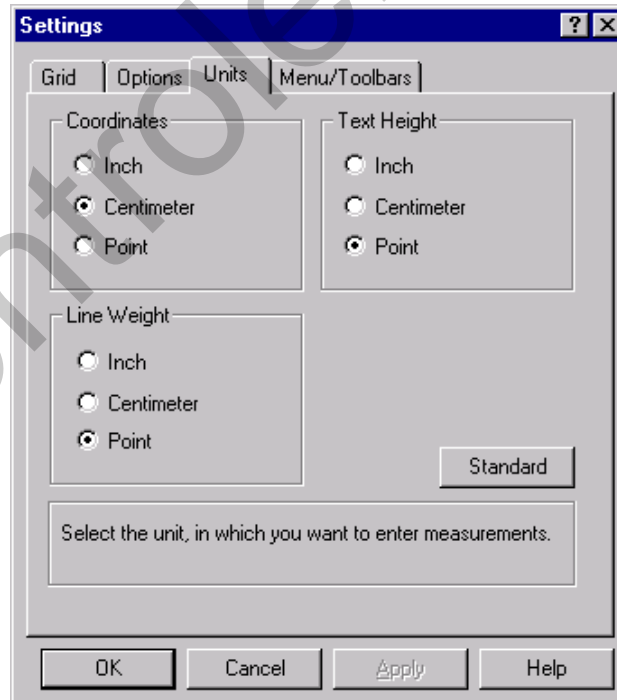

### "Menu/Toolbars" Tab

You use the "Menu/Toolbars" tab to set the appearance and properties of the menu bar and toolbars.



### 3.1.17 Window Menu

#### New Window

Use the "New Window" command to create a copy of the current layout in another window. This means you can display different segments of a layout at the same time.

























#### Arrange Icons

Arrange all of the layouts which are reduced to icons in the workspace in the left lower half of the picture.

### 3.1.18 Standard Palette

The standard palette contains buttons you can click on with the mouse in order to execute commands which you need often.





The following buttons are available:

Symbol	Description
	New file
	Open file
	Save File
	Cut
	Copy
	Paste
	Undo
	Redo
	Print
	Static Part
	Dynamic Part
	Cover Sheet
	Report Contents
	Final Page
	Place On Top
	Place On Bottom
	Grid On/Off
	Snap to Grid
	Zoom In
	Zoom Out
	Zoom Area
	Copy properties of selected object
	Assign Properties
	Display Object Properties
	Turn on Context Sensitive Help



### 3.1.19 Text Palette

Use the text palette to quickly change the most important text attributes of text objects as well as the line color of standard objects.

Symbol	Description
	Change Font
	Change Font Size
	Change Font Attribute
	Change Font Color
	Change Line Color

#### Changing the Font

The font that is set currently is displayed in the box.



#### Changing the Font Size

The font size that is set currently is displayed in points (pt) in the box.

#### Changing the Text Attributes

Use these three buttons to change the text attributes.

#### Changing the Font Color

Use this button to change the font color.

#### Changing the Line Color

The function affects the following colors:

- The color of the border in area objects
- The line color in line objects

### 3.1.20 Status Bar

In addition to general program information, the status bar displays the name of the selected object and its position coordinates.

### 3.1.21 Object Properties

The "Object Properties" dialog window displays the properties of a selected object, an object group, or the defaults for an object type. These properties can be changed or copied. You can also connect dynamic objects with applications here.

#### Structure

The "Properties" dialog window consists of the following items:

- Pin to fix the dialog window
- Pipettes to copy and transfer properties
- Object List
- "Properties" Tab
- "Making Connections"

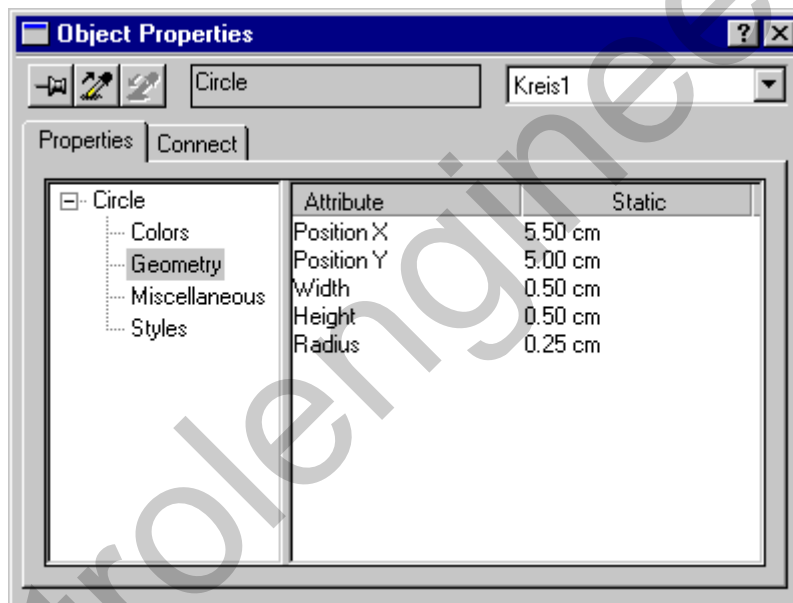



#### Pin

The pin gives you the opportunity to affix the "Properties" dialog window to a specific location on the screen. You can move the window to any desired position. The window remains open even when other objects are being edited. Its contents conform to each object selected.

## Pipettes for Transferring Object Properties

### How to Transfer Object Properties:

1. Double click on the object whose properties you want to transfer. This action opens the "Properties" dialog window.
2. Click on the pin to affix the "Properties" dialog window.
3. Click on the left pipette  icon.
4. In the object list or the workspace, select the object to which you want to transfer the copied properties.
5. Click on the right pipette  icon.

### Object List

In the object list, you can select additional objects in order to edit them without closing the "Properties" dialog window.

### "Properties" Tab

Define the properties of the selected object in the "Properties" tab.

The object properties are arranged in groups in a subject tree in the left half of the "Properties" tab. The right half of the window displays the respective attributes of each group together with their settings. Depending on the type of attribute, you can change the attributes by means of value entry, palettes, or pop-up menus.

The following groups can be selected depending on the object:

- Colors
- Geometry
- Font
- Miscellaneous
- Styles

### 3.1.21.1 Changing Attributes

Various procedures for changing attributes are described in more detail in the following:

#### How to Change an Attribute with Switchover:

1. Select the desired group in the left half of the properties window. The corresponding attributes are displayed in the right half of the window.
2. Double-click on the line with the corresponding attribute or the property set in the "Static" column - for example, Object: Static Text; Subject: Font; Attribute: Bold. Click on one of the options offered.



for example

or

Click the right mouse button on the property that is set in the "Static" column. The pop-up menu opens. Click on the "Edit" menu item, then click on the desired property of the attribute.

#### How to Change an Attribute by Selecting One of Multiple Options:

1. Select the desired group in the left half of the properties window. The corresponding attributes are displayed in the right half of the window.
2. Double-click on the line with the appropriate attribute or on the property set in the "Static" column, for example: page number; Subject: Font; Attribute: X Alignment. Click on one of the options offered.



for example

or

Click the right mouse button on the property that is set in the "Static" column. The pop-up menu opens. Select the "Edit" menu, then select the desired property for the attribute.

### How to Change the Value of an Attribute:

1. Select the desired group in the left half of the properties window. The corresponding attributes are displayed in the right half of the window.
2. Double-click on the line with the corresponding attribute or the property set in the "Static" column - for example, Object: Rectangle; Subject: Geometry; Attribute: Width. The input dialog box opens.

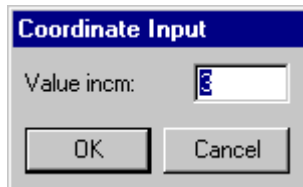

for example

or

Click the right mouse button on the value that is displayed in the "Static" column The pop-up menu opens. Select the "Edit" menu item to open the input dialog box.

3. Enter the new value for the attribute.

### How to Change the Text of an Attribute:

1. Select the desired group in the left half of the properties window. The corresponding attributes are displayed in the right half of the window.
2. Double-click on the line with the corresponding attribute or the property set in the "Static" column - for example, Object: Static Text; Subject: Object ID; Attribute: Object Name. The input dialog box opens.

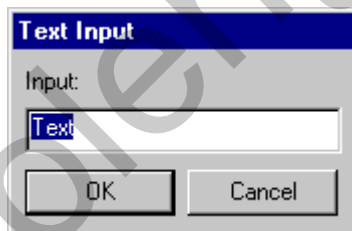

for example

or

Click the right mouse button on the text that is displayed in the "Static" column The pop-up menu opens. Select the "Edit" menu item to open the input dialog box.

3. Enter the new text for the attribute.

### How to Change an Attribute by Changing the Color:

1. Select the desired group in the left half of the properties window. The corresponding attributes are displayed in the right half of the window.
2. Double-click on the line with the corresponding attribute or the color displayed in the "Static" column - for example, Object: Ellipse Arc; Subject: Colors; Attribute: Line Color. The color palette opens.



for example

or

Click the right mouse button on the color that is displayed in the "Static" column The pop-up menu opens. Choose "Edit" from the menu to open the color palette.

3. Select the new color for the attribute.

or

Use the "Others..." menu item to access other colors for the attribute.

### How to Change the Pattern of an Attribute:

1. Select the desired group in the left half of the properties window. The corresponding attributes are displayed in the right half of the window.
2. Double-click on the line with the corresponding attribute or the pattern displayed in the "Static" column - for example, Object: Rectangle; Subject: Styles; Attribute: Fill Pattern. This opens the pattern palette.

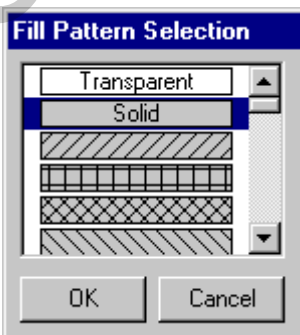

for example

or

Click the right mouse button on the pattern that is displayed in the "Static" column The pop-up menu opens. Choose "Edit" from the menu to open the pattern palette.

3. Select the new pattern for the attribute.

### How to Change the Line Style of an Attribute:

1. Select the desired group in the left half of the properties window. The corresponding attributes are displayed in the right half of the window.
2. Double-click on the line with the corresponding attribute or the line displayed in the "Static" column - for example, Object: Circle; Subject: Styles; Attribute: Line Style. The Line Style selection dialog box opens.

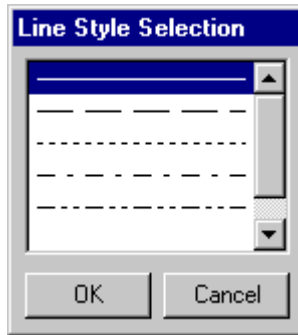

for example

or

Click the right mouse button on the line style that is displayed in the "Static" column. The pop-up menu opens. Choose "Edit" from the menu and the Lines selection dialog box opens.

3. Select the new line style for the attribute.

### How to Change the Line Weight of an Attribute:

1. Select the desired group in the left half of the properties window. The corresponding attributes are displayed in the right half of the window.
2. Double-click on the line with the corresponding attribute or the line displayed in the "Static" column - for example, Object: Circle; Subject: Styles; Attribute: Line Width. The Line Weight selection dialog box opens.



for example

or

Click the right mouse button on the line weight that is displayed in the "Static" column. The pop-up menu opens. Choose "Edit" from the menu and the Lines selection dialog box opens.

3. Select the new line weight for the attribute.

### How to Change the Font of an Attribute:

1. Select the desired group in the left half of the properties window. The corresponding attributes are displayed in the right half of the window.
2. Double-click on the line with the corresponding attribute or the font displayed in the "Static" column - for example, Object: Static Text; Subject: Font; Attribute: Character Set. The Fonts selection dialog box opens.

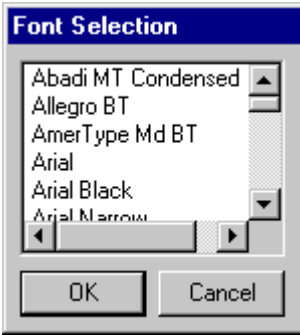

for example

or

Click the right mouse button on the font that is displayed in the "Static" column. The pop-up menu opens. Choose "Edit" from the menu and the Fonts selection dialog box opens.

3. Select the new font for the attribute.



### How to Change the Number of Columns in a Table:

**Attention:**

The number of columns is determined and entered automatically when you connect the table with the application. It is possible to change the values determined by the system but it is not necessary in most cases.

1. Select the "Geometry" subject in the subject tree. The corresponding attributes are displayed in the right half of the window.
2. Double click on the "Columns" attribute or on the number of columns displayed. This opens the input dialog for table columns.

or

Click the right mouse button on the displayed number of columns. The pop-up menu opens.

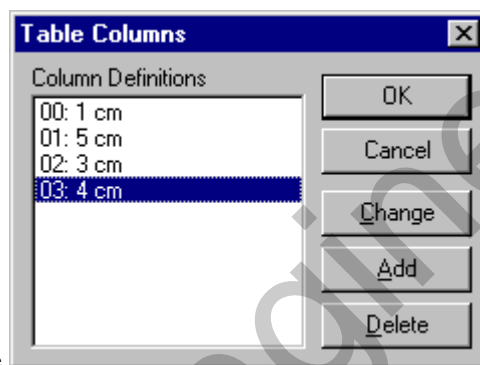

for example

3. Click on the "Add" button to add a column with a default width of 1 cm to the table.
- or
4. In the "Column Definition" window, click on the column to be deleted and then click the "Remove" button.

**Note:**

In the "Column Definition" window, the column numbers beginning with 00, 01, 02, etc., are to the left of the colon (:) and the corresponding column widths in centimeters are to the right of the colon.

## How to Change the Column Width of a Table:

### Attention:

The column width is determined automatically when you connect the table with the application and, with the addition (relative), entered in the place of centimeters. It is possible to change the values determined by the system but it is not necessary in most cases.

1. Select the "Geometry" subject in the subject tree. The corresponding attributes are displayed in the right half of the window.
2. Double click on the "Columns" attribute or on the number of columns displayed. This opens the input dialog for table columns.

or

Click the right mouse button on the displayed number of columns The pop-up menu opens.

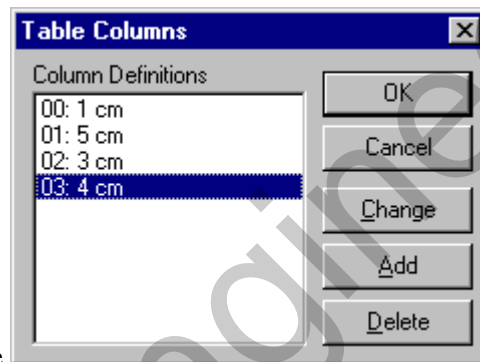

for example

3. In the "Column Definition" window, click the left mouse button on the column whose width you want to change. Select the "Change" button. The input dialog box opens.

or

Double click the left mouse button in the "Column Definition" window on the column whose width you want to change. The input dialog box opens.

4. Enter the column width in centimeters.

### Note:

In the "Column Definition" window, the column numbers beginning with 00, 01, 02, etc., are to the left of the colon (:) and the corresponding column widths in centimeters are to the right of the colon.

## "Connect" Tab

In the "Connect" tab, you can define the connection of the selected dynamic object.

- To connect a dynamic object to an application, first set the connection and then define the data types (selection and possibly specifying the format).
- The connected application provides connection elements.
- Only data types that are already loaded in each application are offered.

The left half of the "Connect" tab displays the connected application. The right half of the window contains the selection possibility in the "Name" column and, when available, the format possibilities.

If the icon is displayed with a red check mark (see Selection), settings were already carried out using the "Edit..." button.

With "Delete..." only the edited inputs (selection and format) are reset. The selection possibilities are retained. Press the "Connect..." button to start the "Connecting Dynamic Objects" dialog.

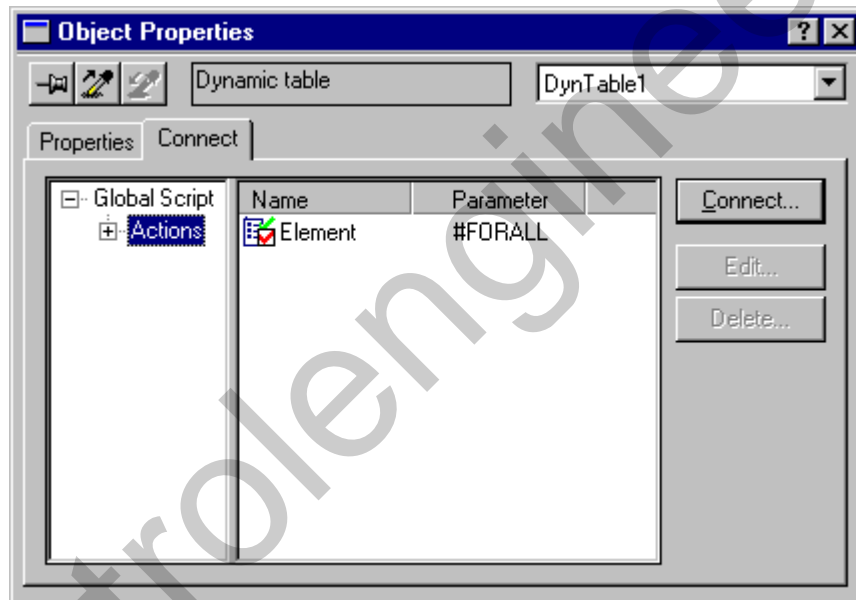

### Connecting dynamic objects

1. Enter a dynamic object into the dynamic part of the page layout.  
or  
Click on a dynamic object in the page layout.
2. Open the "Properties" dialog window.
3. Click on the "Making Connections" tab in the "Properties" dialog window and then click on the "Connect..." button to start the "Connect" dialog.



4. In the "Connect" dialog, select the corresponding type from the applications listed by double clicking on it or by clicking "OK."

---

#### Note:

All of the available types are listed but you can only connect the types that are appropriate (for example, dynamic metafile with trend).

If you installed the option packages, these are also offered for documentation. The tab display above then also contains those connections.

---

## 3.2 Editor for Line Layouts

The editor for line layout contains the following:

- Menu Bar
- Standard palettes for rapid operation
- Status Bar

### 3.2.1 Menu Bar

All of the menu commands available in the line printer layout editor are divided into groups and assigned to different menus in the menu bar.

To execute a command, open the appropriate menu, click on the command and, if a dialog opens, enter the desired parameters.









Commands that cannot be activated are displayed light gray.

Menu	Menu Command	Shortcut
File	New	Ctrl + N
	Open...	Ctrl + O
	Save	Ctrl + S
	Save...	
	Print...	Ctrl + P
	Print Preview	
	Printer Setup...	
	File List	
	Exit	
Edit	Cut	Ctrl + X
	Copy	Ctrl + C
	Paste	Ctrl + V
Help	Help Topics	
	Info about current application	

### 3.2.2 Standard Palette

The standard palette contains buttons you can click on with the mouse in order to execute commands which you need often.

The following buttons are available:

Symbol	Description
	New File
	File, Open Menu
	Save File
	Cut
	Properties
	Paste
	Print
	Turn on Context Sensitive Help

### 3.2.3 Status Bar

In addition to general program information, the status bar displays the name of the selected object and its position coordinates.

controlengineers.ir

## 4 Connecting Report Layouts with the Applications















In order to output the configured data (project documentation) and the on-line data from runtime (such as messages and measurement values), you must connect the dynamic objects of the report layout with the data from each application.

### 4.1 Selecting the Data for Project Documentation

#### 4.1.1 Selecting Message Data for the Report Output in the Alarm Logging Configuration System

In WinCC, the Report Designer is available for the project documentation of the configured data.

The Alarm Logging editor (configuration system) offers the following data for the project documentation.

-  **Alarm Logging CS**
-  Message Blocks
-  System Blocks
-  User Text Blocks
-  Process Value Blocks
-  Message Line Formats
-  Message Window Templates
-  Message Classes
-  Single Messages
-  Group Messages
-  Message Class
-  User-Defined
-  Archives
-  Reports

---

#### Note:

You can only select the data for project documentation for the "Single Messages" type. For all other message types, the data are output according to the configuration.

You can find more about the individual, documentable parameters in the description of the Alarm Logging editor.

---



#### 4.1.1.1 Selecting Single Messages in the Alarm Logging Configuration System

##### How to Set the Single Messages for the Output:

1. Select a "Dynamic Table", open the "Properties" dialog, and select the "Connection" tab.

If the object is already connected to a single message in the Alarm Logging configuration system (entry in the left half of the window), you can then set the single message.

If there is no connection to the single messages in the Alarm Logging configuration system, you must create the connection by means of the "Connect..." button.

2. Click on the Selection entry in the Name column. The "Edit..." button can be selected now.
3. Click the "Edit..." button to open the dialog in which you can select the single messages.

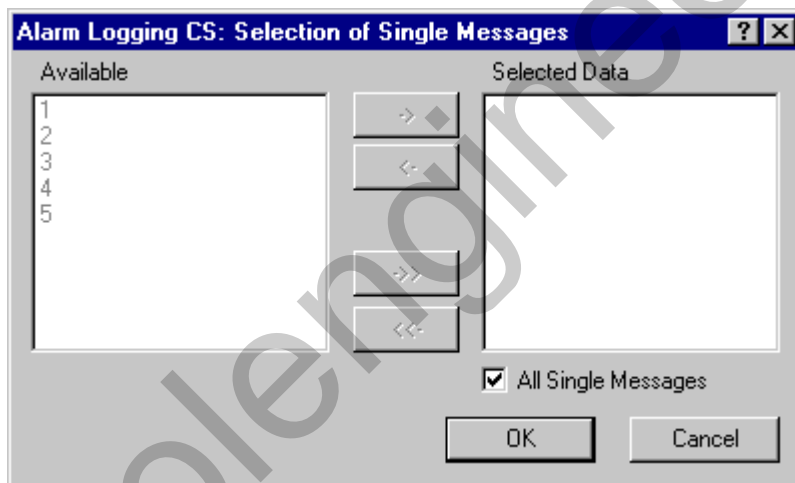

4. The selection "All Single Messages" is set as a default. This setting triggers the output of all of the configured single messages that are available when the report is output. If you want to select specific single messages, deactivate the "All Single Messages" selection to enable the buttons for selecting the single messages.
5. Select the desired messages from the list of available messages and transfer them individually or in groups to the list of selected messages using the appropriate buttons in the dialog.  
Messages that were configured after the page layout was created are not included in the report.

## 4.1.2 Selecting Data for the Report Output in the WinCC Explorer

In WinCC, the Report Designer is available for the project documentation of the configured data.

The WinCC Explorer offers the following data for the project documentation.

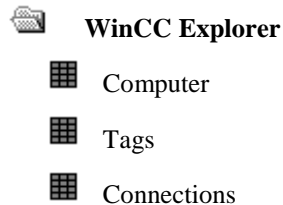

---

### Note:

You can find more about the individual, documentable parameters in the description of the WinCC Explorer.

---

### 4.1.2.1 Selecting a Computer in the WinCC Explorer

#### How to Select a Computer:

1. Select a "Dynamic Table", open the "Properties" dialog, and select the "Connection" tab.

If the object is already connected to a computer in the WinCC Explorer (entry in the left half of the window), you can then set the computer name.

If there is no connection to the computer in the WinCC Explorer, you must create the connection by means of the "Connect..." button.

2. Click on the "Computer Name Selection" entry in the "Name" column. The "Edit..." button can be selected now.
3. Click the "Edit..." button to open the dialog in which you can select the computer name.

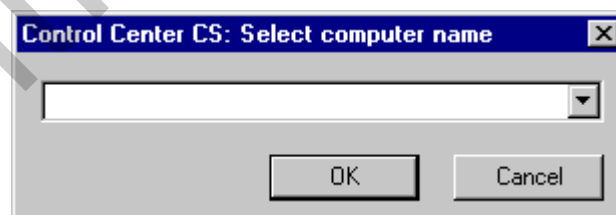

4. From the list of available computers, select the computer you want and confirm the selection by clicking "OK."

---

### Note:

You can find more about the individual, documentable data in the description of the WinCC Explorer.

---

### 4.1.2.2 Selecting Tags in the WinCC Explorer

#### How to Create the Connection to the Tags:

1. Select a "Dynamic Table", open the "Properties" dialog, and select the "Connection" tab.

If the object is already connected to the tags in the WinCC Explorer (entry in the left half of the window), you can then carry out the selection of the tags.

If there is no connection to the tags in the WinCC Explorer, you must create the connection by means of the "Connect..." button.

2. Click on the entries for "Selection" in the "Name" column. The "Edit..." button can be selected now. You can select the tag parameters, the tag groups, and the tags, as well as determine their format.

#### How to Select the Tag Parameters:

1. Ensure that the connection to the tags is already established.
2. Click on the "Tag Parameter Selection" entry in the "Name" column. The "Edit..." button can be selected now.
3. Click the "Edit..." button to open the dialog in which you can select the data.

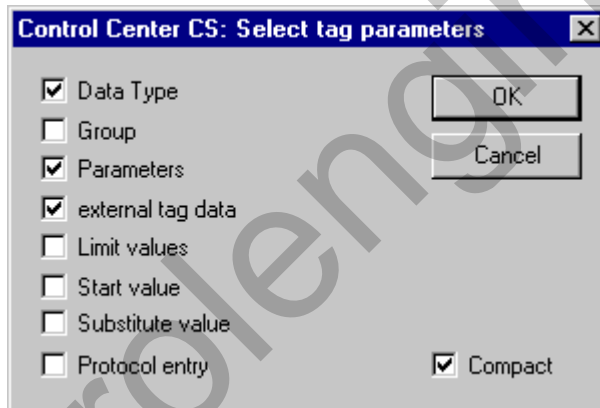

4. Use the selection boxes to select the data you want to output in the report. All of the data boxes marked with check marks are output.
5. Select the check-box "Compact" to display the report in a more compact form. In the compacted display, one tag will be displayed per line. Otherwise every attribute requires a line.

---

#### Note:

You can find more about the individual, documentable parameters in the description of the WinCC Explorer.

---

### How to Select the Tag Groups:

1. Ensure that the connection to the tags is already established.
2. Click on the "Tag Groups Selection" entry in the name column. The "Edit..." button can be selected now.
3. Click the "Edit..." button to open the dialog in which you can select the data.

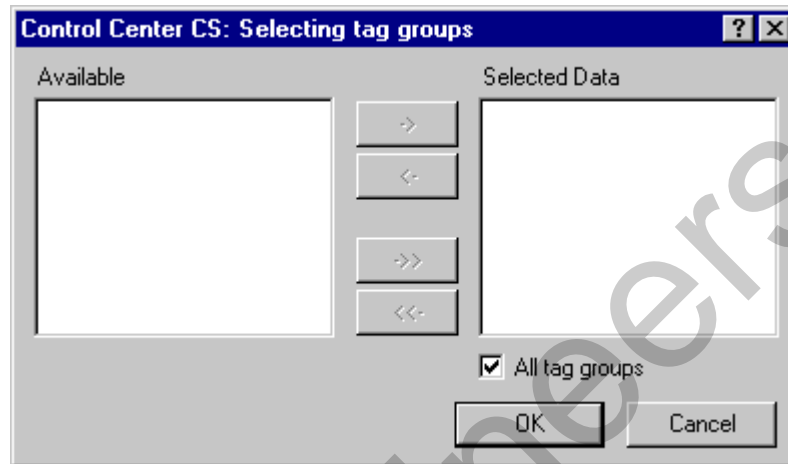

4. The selection "All Tag Groups" is set as a default. This setting triggers the output of all of the configured tag groups that are available when the report is output. If you want to select specific tag groups, deactivate the "All Tag Groups" selection to enable the buttons for selecting the tag groups.
5. Select the desired tag groups from the list of available tag groups and transfer them individually or in groups to the Column Sequence of the Report window using the appropriate buttons in the dialog.  
Tag groups that were configured after the page layout was created are not included in the report.

---

#### Note:

You can find more about the individual, documentable parameters in the description of the WinCC Explorer.

---

**How to Select the Tags:**

1. Ensure that the connection to the tags is already established.
2. Click on the "Tag Parameter Selection" entry in the "Name" column. The "Edit..." button can be selected now.
3. Click the "Edit..." button to open the dialog in which you can select the data.

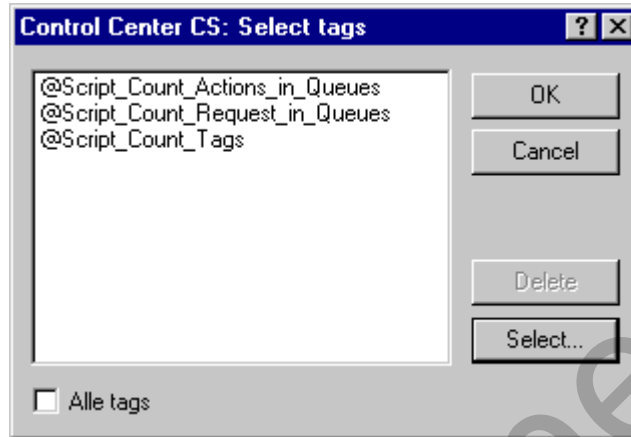

4. The selection "All Tag Groups" is set as a default. This setting triggers the output of all of the configured tags that are available when the report is output. If you want to select specific tags, deactivate the "All Tags" selection to enable the buttons for selecting the tags.
5. Click on the "Select..." button to open the dialog in which you can select the tags.

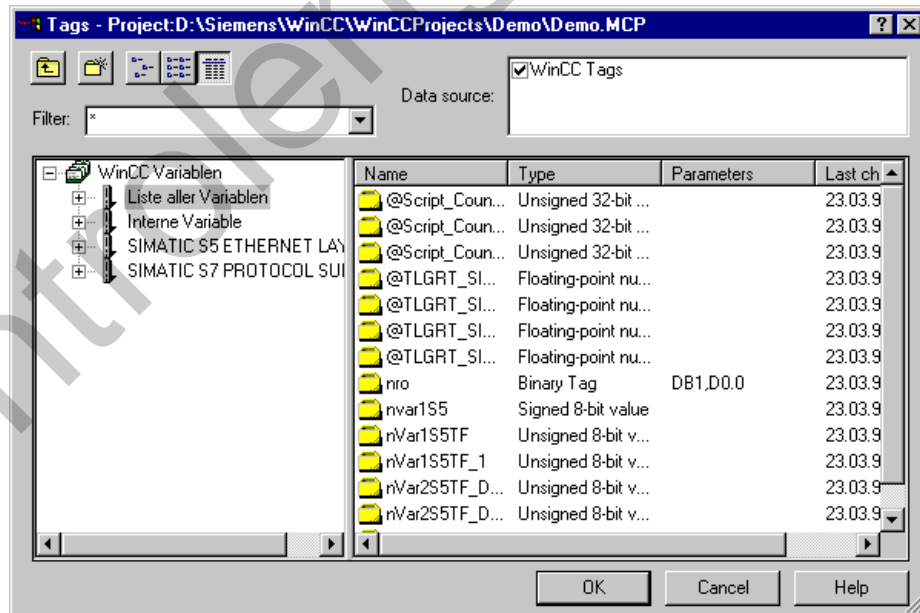

6. Select one or more tags and click "OK" to accept them.

**Note:**

You can find more about the individual, documentable parameters in the description of the WinCC Explorer.

### How to Format the Tag List:

1. Ensure that the connection to the tags is already established.
2. Click on the "Format" entry in the "Name" column. The "Edit..." button can be selected now.
3. Click the "Edit..." button to open the dialog in which you can select the data.



4. The selection "Use short type name" is set as a default. You can deactivate this default setting.

### 4.1.3 Selecting Data for the Report Output in Global Scripts

In WinCC, the Report Designer is available for the project documentation of the configured data.

The Global Scripts editor offers the following data for the project documentation.

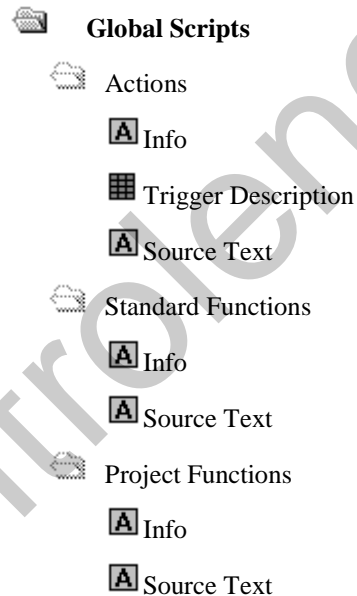

---

#### Note:

You can find more about the individual, documentable parameters in the description of Global Scripts.

---

### 4.1.3.1 Selecting Actions and Functions

#### How to Select the Elements for the Output:

1. Select a "Dynamic Text" or a "Dynamic Table", open the "Properties" dialog, and select the "Connection" tab.

If the object is already connected to Global Scripts (entry in the left half of the window), you can then set the elements.

If there is no connection to Global Scripts, you must create the connection by means of the "Connect..." button.

2. In the "Connection" tab, click on actions, standard functions, or project functions (depending on the connection) in the left half of the window.
3. In the right half of the window, click on the "Group Element" entry in the "Name" column. The "Edit..." button can be selected now.
4. Click the "Edit..." button. to open the dialog in which you can select the elements.

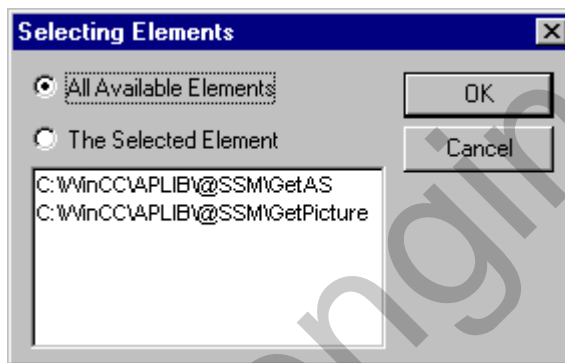

5. The selection "All Available Elements" is set as a default. This setting triggers the output of all of configured elements that are available when the report is output.

or

Click on the "All Available Elements" entry and select an element from the list.

---

#### Note:

In the "Properties" dialog and "Connection" tab, the #FORALL entry in the "Parameters" column for the group element means that all available elements were output.















You can find more about the individual, documentable data in the description of Global Scripts.

---

#### 4.1.4 Selecting Archive Data for the Report Output in Graphics Designer

In WinCC, the Report Designer is available for the project documentation of the configured data.

The Graphics Designer editor offers the following data for the project documentation.

-  **Graphics Designer**
-  **Picture**
  -  General Display
  -  Picture Statistics
  -  Attributes
  -  Embedded Objects
  -  Scripts
  -  Triggers
  -  Direct Connections
-  **Object**
  -  Object Statistics
  -  Attributes
  -  Scripts
  -  Triggers
  -  Direct Connections

---

#### Note:

You can make a selection of the elements for all of the information in a picture and in an object. As a default, all of the elements of the connected type are selected.

With the exception of the general display, embedded objects, and direct connections, you can make additional selections of the data.

---



#### 4.1.4.1 Selecting Picture Data and Objekt Data in the Graphics Designer

##### How to Select the Elements for the Output:

1. Select a "Dynamic Text", a "Dynamic Table", or a "Dynamic Metafile", open the "Properties" dialog, and select the "Connection" tab.

If the object is already connected with Graphics Designer, (entry in the left half of the window), you can then set the elements of the connected data type.

If there is no connection to Graphics Designer, you must create the connection by means of the "Connect..." button.

2. In the "Connection" tab, click on an entry of the connected data type in the left half of the window. If the "Group Element" entry appears in the right half of the window in the "Name" column, you can select the elements for this type.
3. In the right half of the window, click on the "Group Element" entry in the "Name" column. The "Edit..." button can be selected now.
4. Click the "Edit..." button to open the dialog in which you can select the elements.

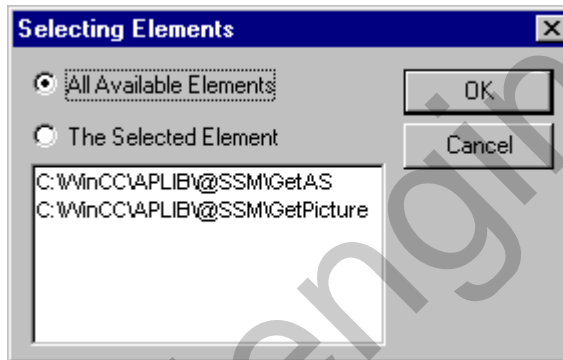

5. The selection "All Available Elements" is set as a default. This setting triggers the output of all of configured elements that are available when the report is output.  
or  
Click on the "All Available Elements" entry and select an element from the list.

---

##### Note:

In the "Properties" dialog and "Connection" tab, the #FORALL entry in the "Parameters" column for the group element means that all available elements were output.

You can find more about the individual documentable data in the description of Graphics Designer.

---

#### 4.1.4.2 Selecting Statistical Data on the Picture in the Graphics Designer

##### How to Select the Statistical Data on the Picture for the Output:

1. Select a "Dynamic Table", open the "Properties" dialog, and select the "Connection" tab.

If the object is already connected with picture statistics in the Graphics Designer (entry in the left half of the window), you can then set the elements and the picture statistics.

If there is no connection to the picture statistics in the Graphics Designer, you must create the connection by means of the "Connect..." button.

2. In the "Connection" tab, click on an entry of the picture statistics in the left half of the window.
3. In the right half of the window, click on the "Statistical Data on the Picture" entry in the "Name" column. The "Edit..." button can be selected now.
4. Click the "Edit..." button to open the dialog in which you can select the elements.

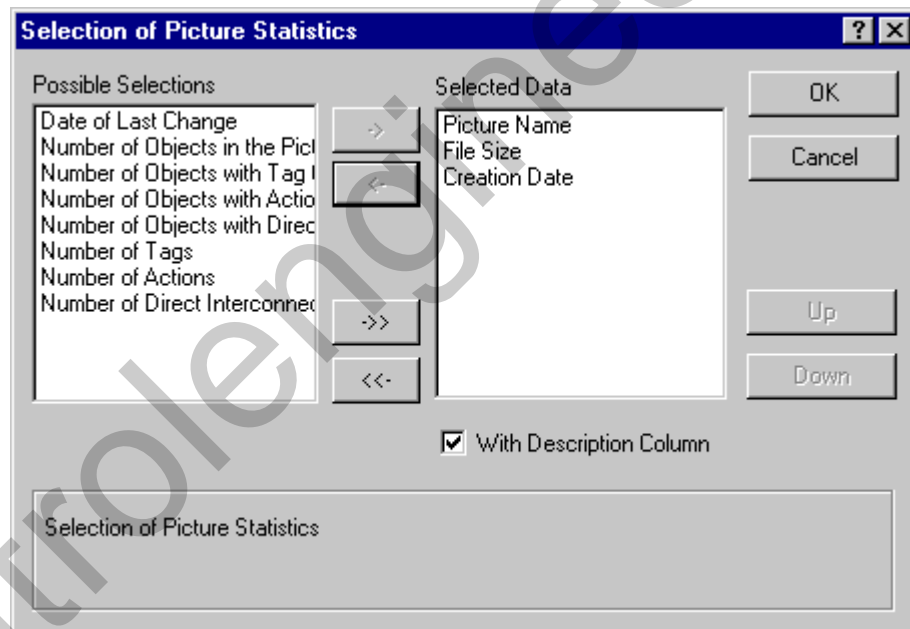

5. Select the desired data from the list of available selection possibilities and transfer them individually or in groups to the list of selected data using the appropriate buttons in the dialog.
6. The selection "with description column" is set as a default. You can deselect it if you need to.

---

##### Note:

You can find more about the individual documentable data in the description of Graphics Designer.

---

#### 4.1.4.3 Selecting attributes of a picture in the Graphics Designer

##### How to Select the Table Data for the Output:

1. Select a "Dynamic Table", open the "Properties" dialog, and select the "Connection" tab.

If the object is already connected with attributes of the picture or object in the Graphics Designer (entry in the left half of the window), you can then set the elements and the table data.

If there is no connection to the attributes of the picture or object in the Graphics Designer, you must create the connection by means of the "Connect..." button.

2. In the "Connection" tab, click on the "Attributes" entry in the left half of the window.
3. In the right half of the window, click on the "Table Data" entry in the "Name" column. The "Edit..." button can be selected now.
4. Click the "Edit..." button to open the dialog in which you can select the table data.

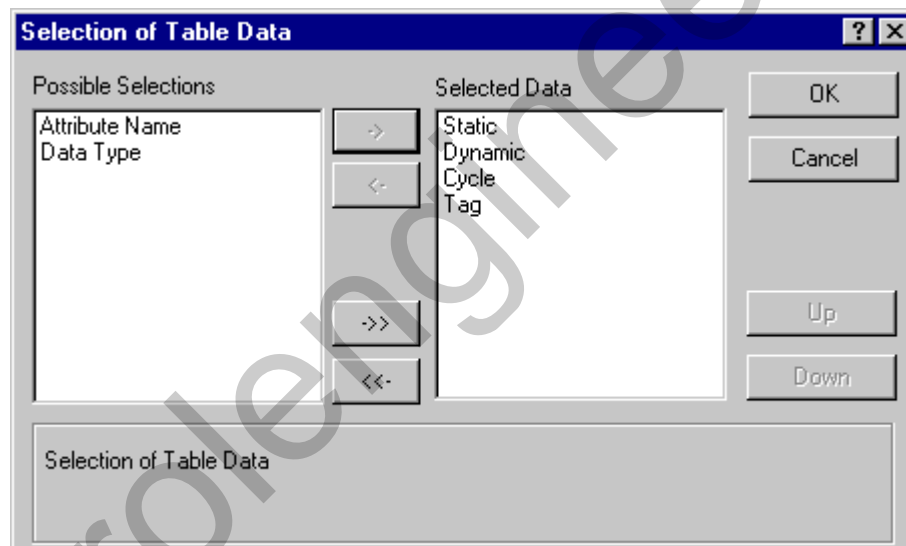

5. Select the desired data from the list of available selection possibilities and transfer them individually or in groups to the list of selected data using the appropriate buttons in the dialog.

---

##### Note:

You can find more about the individual documentable data in the description of Graphics Designer.

---

#### 4.1.4.4 Selecting Scripts for the Output in Graphics Designer

##### How to Select Scripts for the Output:

1. Select a "Dynamic Table", open the "Properties" dialog, and select the "Connection" tab.

If the object is already connected with scripts of the picture or object in the Graphics Designer (entry in the left half of the window), you can then set the elements and the script types.

If there is no connection to the scripts of the picture or object in the Graphics Designer, you must create the connection by means of the "Connect..." button.

2. In the "Connection" tab, click on the "Scripts" entry in the left half of the window.
3. In the right half of the window, click on the "Selecting Scripts" entry in the "Name" column. The "Edit..." button can be selected now.
4. Click the "Edit..." button to open the dialog in which you can select the script types.

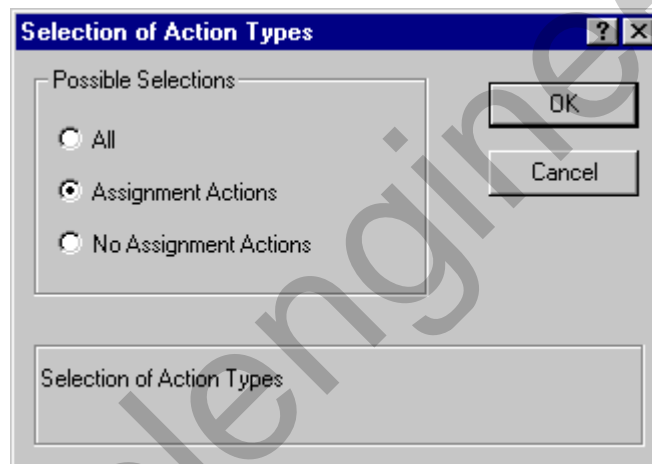

5. The checkbox "All" is checked by default. This setting triggers the output of all of the configured scripts that are available when the report is output.

or

Click on one of the alternative entries.

---

##### Note:









You can find more about the individual, documentable data in the description of Graphics Designer.

---

### 4.1.5 Selecting Archive Data for the Report Output in the Tag Logging Configuration System

In WinCC, the Report Designer is available for the project documentation of the configured data.

The Tag Logging editor offers the following data for the project documentation:

-  **Tag Logging CS**
-  TimersTimers
-  Archives
  -  Process Value Archive
  -  User Archive
  -  Compressed Archive
  -  Process Value Archive Tag
  -  Compressed Archive Tag

---

**Note:**

In the project documentation of the timers, all of the configured timers are output. You cannot make any additional selection.

In the project documentation of the archives, you can select the archives individually. As a default, all of the configured archives of the selected type (process value, user, or compressed archive) are output.

In the project documentation of the archive tags, you can select the tags individually. As a default, all of the configured tags of the selected type (process value or user archive tags) are output.

You can find more about the individual, documentable parameters in the description of the Tag Logging editor.

---

### 4.1.5.1 Selecting Archives for the Report Output in the Tag Logging Configuration System

#### How To Set the Archives:

1. Select a "Dynamic Table", open the "Properties" dialog, and select the "Connection" tab.

If the object is already connected to an archive in the Tag Logging configuration system (entry in the left half of the window), you can then select the archives.

If there is no connection to an archive in the Tag Logging configuration system, you must create the connection by means of the "Connect..." button.

2. Click on the "Archive Name" entry in the "Name" column. The "Edit..." button can be selected now.
3. Click the "Edit..." button to open the dialog in which you can select the archives.

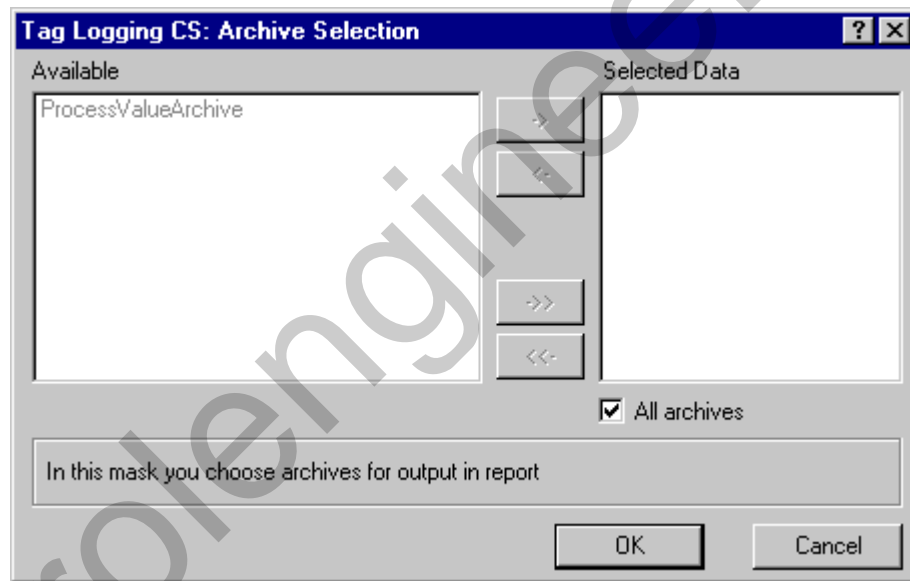

4. The selection "All Archives" is set as a default. This setting triggers the output of all of the configured archives that are available when the report is output. If you want to select specific archives, deactivate the "All Archives" selection to enable the buttons for selecting the archives.
5. Select the desired archives from the list of available archives and transfer them individually or in groups to the list of selected archives using the appropriate buttons in the dialog. Archives that were configured after the page layout was created are not included in the report.

**How to select the process value archive data:**

1. Ensure that the connection to the process value archive is already established.
2. Click on the "Process Value Archive Data" entry in the "Name" column. The "Edit..." button can be selected now.
3. Click the "Edit..." button to open the dialog in which you can select the data.

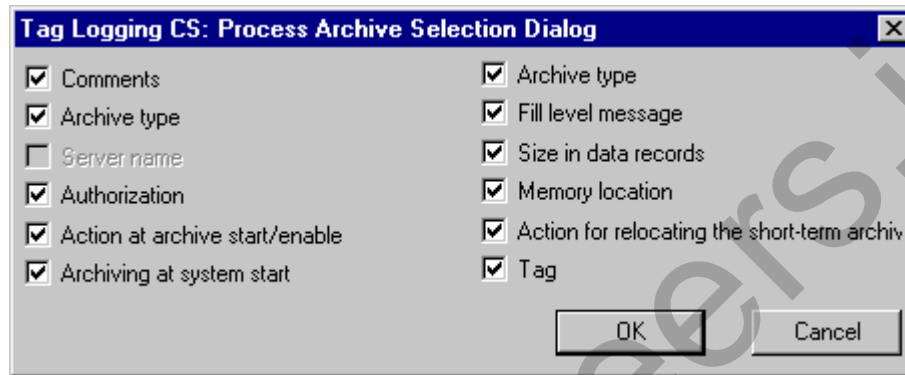

4. Use the selection boxes to select the data you want to output in the report. All of the data boxes marked with check marks are output.

**Note:**

You can find more about the individual, documentable parameters in the description of Tag Logging.

**How to Select the User Archive Data:**

1. Ensure that the connection to the user archive is already established.
2. Click on the "User Archive Data" entry in the "Name" column. The "Edit..." button can be selected now.
3. Click the "Edit..." button to open the dialog in which you can select the data.

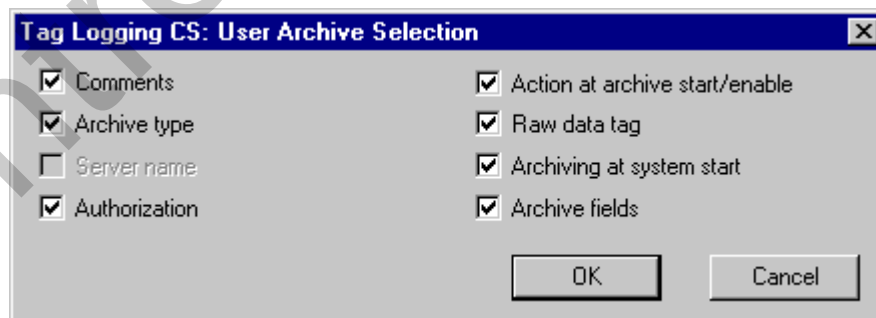

4. Use the selection boxes to select the data you want to output in the report. All of the data boxes marked with check marks are output.

**Note:**

You can find more about the individual, documentable parameters in the description of Tag Logging.

### How to Select the Compressed Archive Data:

1. Ensure that the connection to the compressed archive is already established.
2. Click on the "Compressed Archive Data" entry in the "Name" column. The "Edit..." button can be selected now.
3. Click the "Edit..." button to open the dialog in which you can select the data.

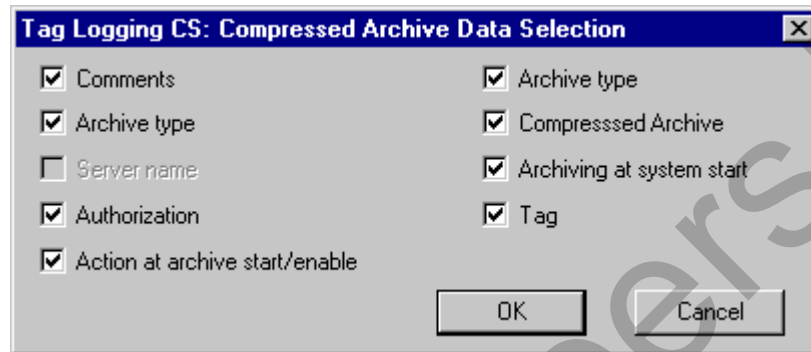

4. Use the selection boxes to select the data you want to output in the report. All of the data boxes marked with check marks are output.

---

#### Note:

You can find more about the individual, documentable parameters in the description of Tag Logging.

---



#### 4.1.5.2 Setting Archive Tags for the Report Output in the Tag Logging Configuration System

##### How to Set the Archive Tags:

1. Select a "Dynamic Table", open the "Properties" dialog, and select the "Connection" tab.

If the object is already connected to an archive tag in the Tag Logging configuration system (entry in the left half of the window), you can then select the archives.

If there is no connection to an archive tag in the Tag Logging configuration system, you must create the connection by means of the "Connect..." button.

2. Click on the "Tag" entry in the "Name" column. The "Edit..." button can be selected now.
3. Click the "Edit..." button to open the dialog in which you can select the archive tags.

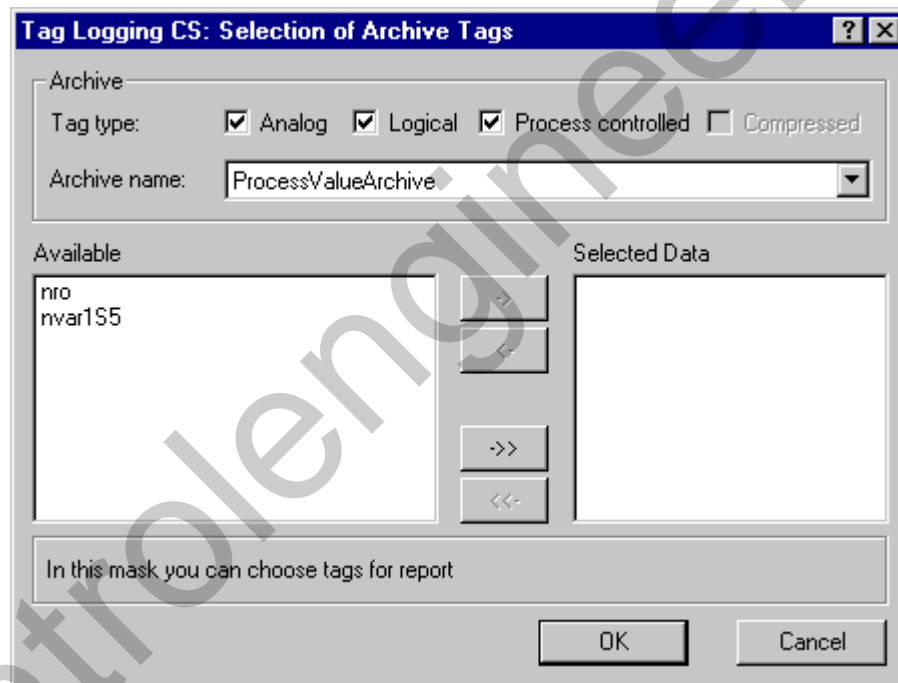

4. Select the tag type and the archive name. The available archive tags are displayed.
5. Select the desired tags from the list of available tags and transfer them individually or in groups to the list of selected tags using the appropriate buttons in the dialog.

### How to Select the Tag Data :

1. Ensure that the connection to the archive tags (process or compressed value) is already established.
2. Click on the "Tags" entry in the "Name" column. The "Edit..." button can be selected now.
3. Click the "Edit..." button to open the dialog in which you can select the data.

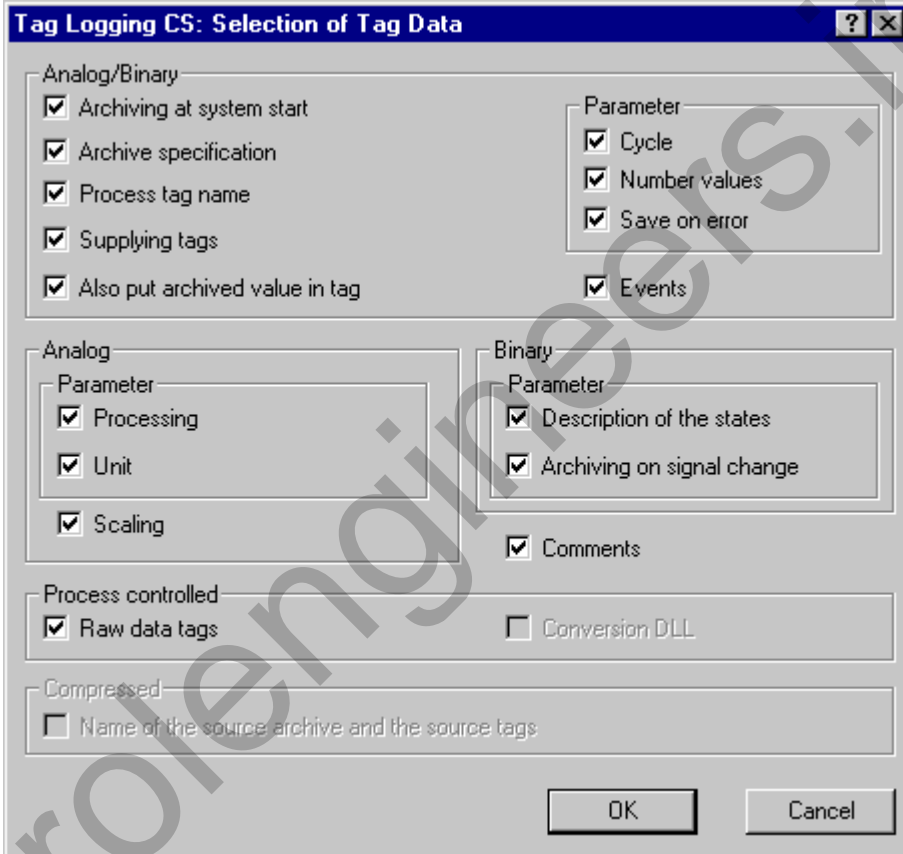

**Tag Logging CS: Selection of Tag Data**

**Analog/Binary**

- Archiving at system start
- Archive specification
- Process tag name
- Supplying tags
- Also put archived value in tag

**Parameter**

- Cycle
- Number values
- Save on error
- Events

**Analog**

**Parameter**

- Processing
- Unit
- Scaling

**Binary**

**Parameter**

- Description of the states
- Archiving on signal change
- Comments

**Process controlled**

- Raw data tags
- Conversion DLL

**Compressed**

- Name of the source archive and the source tags

OK Cancel

4. Use the selection boxes to select the data you want to output in the report. All of the data boxes marked with check marks are output.



#### Note:

You can find more about the individual, documentable parameters in the description of Tag Logging.

## 4.1.6 Selecting the Text Library Data for the Report Generation

In WinCC, the Report Designer is available for the project documentation of the configured data.

The Text Library editor offers the following data for project documentation.

-  **Text Library**
-  Text Library - General Data
-  Text Library - String Table

---

### Note

You can only select the data for project documentation for the "String Table" "Project documentation:String table" type. General data is output according to their configuration.

---

### 4.1.6.1 Selecting the Text Library Languages

#### Determining the output languages:

1. Select the "String Table" object and open its "Properties" dialog. Select the "Making Connections" tab.

If the object is already linked to the language selection (entry in the left dialog), the output languages can be set.

If there is no link to the language selection, it must be established via the "Connect..." button.

2. Click on the Selection entry in the Name column. The "Edit..." button can be selected now.

- Click the "Edit..." button. The language selection dialog will open.

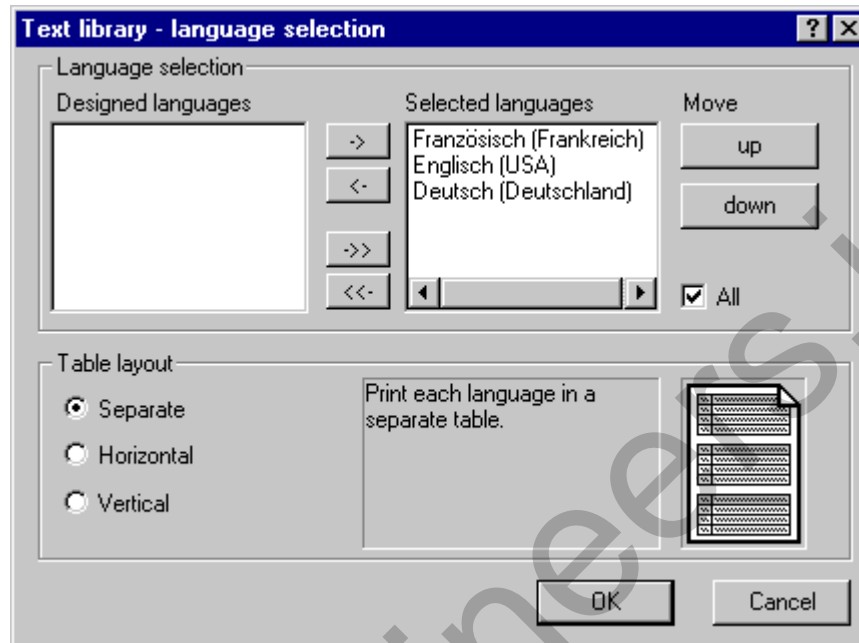

- The check box "All" is checked by default. All the configured languages, that were available at the time of the report output, will be displayed.
- Select the desired language(s) from the list of designed (i.e. configured) languages and transfer them individually or in groups to the list of selected languages using the appropriate buttons in the dialog.

---

**Note:**

Selecting "All" only makes sense if the table layout "Separate" or "Vertical" is selected.

If "All" is selected, the output sequence of the languages is determined by the sequence used in the text library. The sequence can not be influenced by the "Move" buttons.





---

- The sequence, in which the languages are output in the report, corresponds to the sequence of the "Selected Language" list. You can use the "up" and "down" buttons to alter the sequence of the languages.
- Via the "Options" buttons, the layout of the table format can be edited. The effects of the changes are displayed in the "Preview Window".  
Through the "Separate" setting, a separate table will be displayed, for each language, in a report.  
Through the "Horizontal" setting, text belonging to a Text-ID, of a selected language, will be displayed in a single line.  
Through the "Vertical" setting, text belonging to a Text-ID, of a selected language, will be displayed in separate lines.

### 4.1.7 Defining Objects for the Project Document in Alarm Logging Runtime

In WinCC, the services of the Report Designer are available to you for creating message reports.

Alarm Logging runtime offers the following data for the report output:

-  **Alarm Logging Runtime**
  -  Message Sequence Report
  -  Short-Term Archive Report
  -  Sequence Archive Report

#### How to set the Message Blocks for the Output:

1. Select a "Dynamic Table", open the "Properties" dialog, and select the "Connection" tab.

If the object is already connected to Alarm Logging runtime (entry in the left half of the window), you can then set the message blocks.

If there is no connection to Alarm Logging runtime, you must create this connection by means of the "Connect..." button.

2. Click on the Selection entry in the Name column. The "Edit..." button can be selected now.

- Click the "Edit..." button to open the dialog in which you can select message blocks.

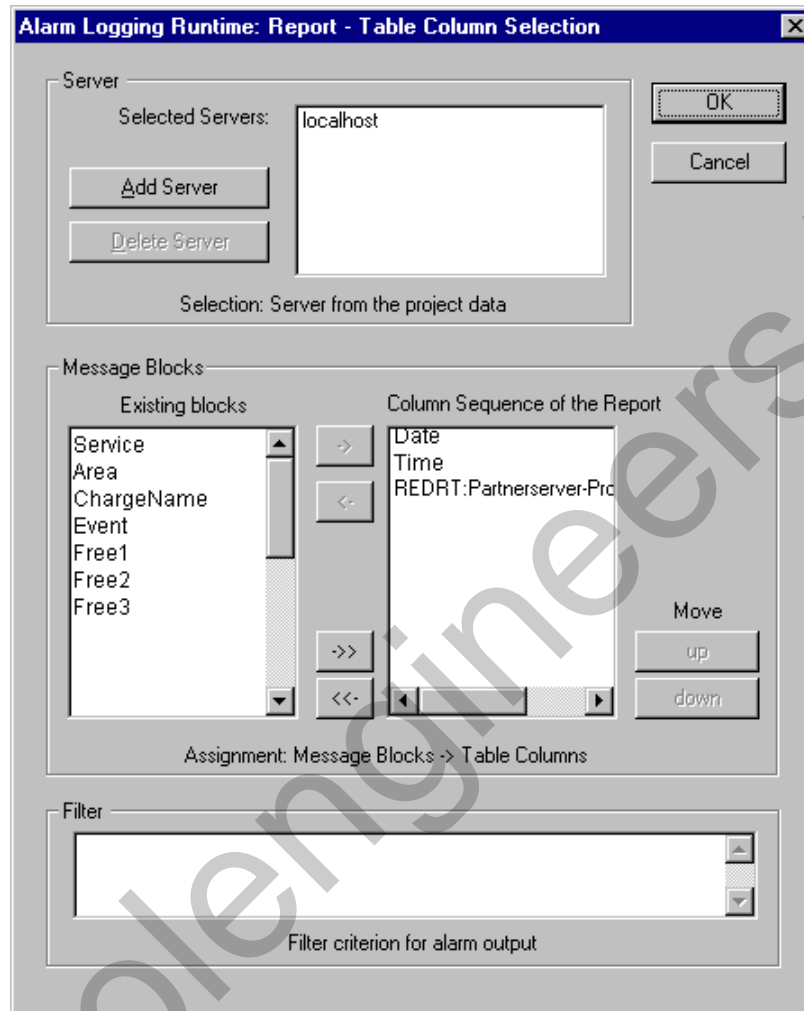

- If you created a client-server or multi-client project, the "Add Server" dialog box will show you a list of all servers, to which a connection has been established. For a single-user system, this dialog box is not required.
- Select the desired message blocks from the list of available message blocks and transfer them individually or in groups to the Column Sequence of the Report window using the appropriate buttons in the dialog.
- In the "Filter" area, filter criteria for the alarm output can be defined. The structure of the filter conditions is server-specific. For WinCC, the following conditions apply:
  - Filter conditions are always linked with the "AND" operand.
  - The structure is as follows: Field, Operand, Value – where the individual parameters are separated by a blank space.  
Example: Date > '17.05.99' AND NR > 100 (all messages after 17.05.99 with a message number greater than 100)
  - Strings, date and time must be enclosed by single quotation marks.

Permitted Arguments:

Name	Type	Data	Example
DATE	Date	'DD:MM:YYYY'	Date >= '20.01.1999' Outputs messages since 20.01.1999
DATE-TIME	Date	'DD:MM:YYYY hh:mm:ss.msmsms'	DATETIME = '03.05.1999 16:00:00' Outputs messages from 03.05.1999 16:00 (24h format)
NR	Integer	Message Number	NR = 10 Outputs message with message number 10
CLASS	Integer	Message Class ID 1-16	CLASS = 12 Outputs messages of the message class 12
TYPE	Integer	Message Type ID 1-256	TYPE >= 50 Outputs messages of the message types 50 to 256
STATE	Integer	Value of ALARM_STATE_xxx Only the operands "=" and "IN(...)" are valid  ALARM_STATE_1 ALARM_STATE_2 ALARM_STATE_3 ALARM_STATE_4 ALARM_STATE_5 ALARM_STATE_6 ALARM_STATE_7 ALARM_STATE_16 ALARM_STATE_17	STATE IN(1,2,3) Outputs all active, cleared and acknowledged messages  Possible Values: 1 = Came in Messages 2 = Went out Messages 3 = Acknowledged Messages 4 = Locked Messages 5 = Enabled Messages 6 = Came in, Acknowledged Messages 7 = Came in, Cleared Messages 16 = Mess. Acknowledged by System 17 = Emergency Acknowledged Messages
AGNR	Integer	PLC Number	AGNR = 2 Outputs messages with the PLC number 2
AGSUBNR	Integer	PLC Sub Number	AGSUBNR = 5 Outputs messages with the PLC sub number 2.
TEXTxx	Text	Search Text for 'Text01'-'Text10'	TEXT02 = Error Outputs the messages whose Text02 is "Error"
PVALUExx	Double or Text	Search Text for PVALUE01- PVALUE10	PVALUE03 Outputs the process value 03
COUNTER	Integer	Message Counter	COUNTER >= 500 Outputs all messages with a counter number of 500 or greater

The following operands are permitted:

>= , <= , = , > , < ,

**IN(...)** multiple values as an array separated by commas, e.g. CLASS IN(1,3,5,7)

**LIKE** Text must only contain the string, e.g. TEXT01 LIKE 'Error' outputs the message whose Text01 contains the search text "Error"

**INLIKE** Combination of IN and LIKE, e.g. INLIKE('Motor','Pump') outputs all messages that contain the string "Motor" or "Pump" (Motor 1, Drives Motor, Heat Pump, etc.)

The operands LIKE and INLIKE are only valid for TEXT arguments.

Arguments and operands other than listed above are not permitted.

---

**Note:**

Use the "Selection" tab in the "Print Jobs" editor to set the time range of the data for the report output.

If you open a layout in the Graphics Designer that has been created with WinCC V4.0 - V4.02, the selection dialog box of WinCC V4 will be displayed. This dialog box is functionally identical to the dialog box displayed above, except that the server selection and filter criteria functions are not offered.

---



### 4.1.8 Defining Objects for the Project Document in Tag Logging Runtime

In WinCC, the services of the Report Designer are available to you for on-line reporting of process and user archives.

Tag Logging runtime offers the following data for the report output:

- Tag Logging Runtime**
  - Tag Table**  
from data in process value and compressed archives
  - Tag Trends**  
from data in process value and compressed archives
  - Fields Table**  
from data in user archives

Tags in process value and compressed archives can be read out in tabular form or as trends. Fields in user archives can only be read out in tabular form.

#### How to Set the Tags and Boxes for Output in Tables:

1. Select a "Dynamic Table", open the "Properties" dialog, and select the "Connection" tab.

If the object is already connected to Tag Logging runtime (entry in the left half of the window), you can then set the tag or box names.

If there is no connection to Tag Logging runtime, a connection must be established via the "Connect..." button.

2. Click on the "Archive Data Selection" entry in the "Name" column. The "Edit..." button can be selected now.
3. Click the "Edit..." button to open the dialog in which you can select the tags or boxes.

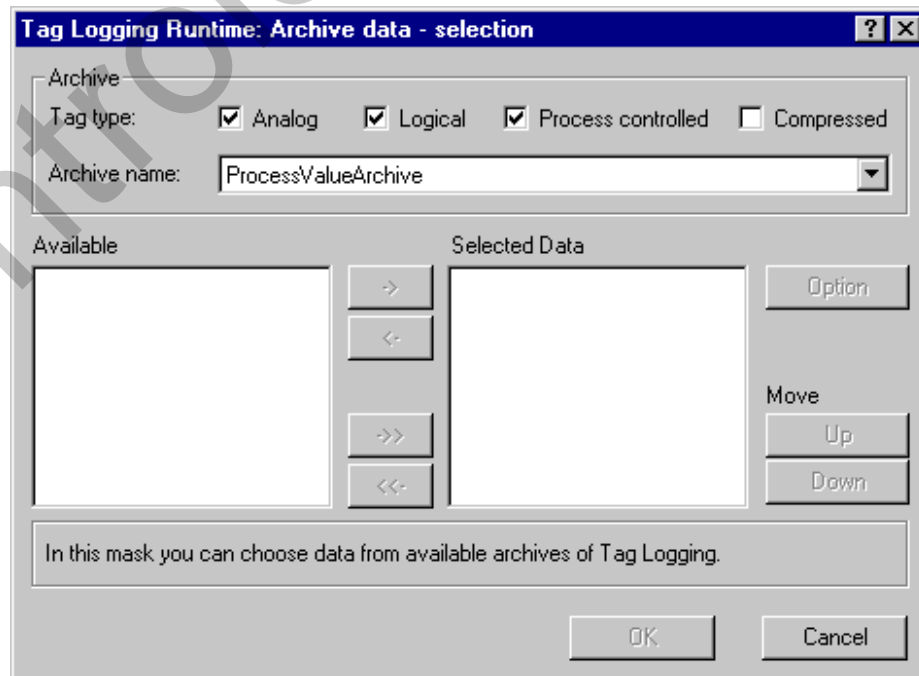

4. Select one or more "Tag Types".
5. Select an "Archive Name" from the list of available archives. The archive data is displayed in the list of available data. For tags, "Time" and "Date" are also available choices, for boxes, "Number" is available as a choice.
6. Select the desired tags from the list of available tags and transfer them individually or in groups to the list of selected tags using the appropriate buttons in the dialog.

---

**Note:**

The number of columns in the layout is adjusted automatically. When you print out the report, it is possible for the contents of the column to be cut off partially!

Use the "Selection" tab in the "Print Jobs" editor to set the time range of the data for the report output.

In Process Value and Compressed Archives, "Date" and "Time" are assigned to the first tag in the list. All additional tags are assigned to this time window. If there are no entries present for additional tags at this time stamp, this column remains empty in the print out.

The display of tags with different acquisition times in a table with a shared time column is problematic, since the tag values might not correspond to the indicated archived times of the time column.

You can select tags in connection with date, with time, or with both. You cannot output time and/or date without a tag.

With user archives, the "Number" box is offered for the output. The number corresponds to the record number of the archive and is valid for all of the boxes of the selected archive.

You can select tags in connection with the number. You cannot output the number without a tag.

---

### How to Set the Tags for the Output in Trends:

1. Select a "Dynamic Table", open the "Properties" dialog, and click on the "Connection" tab.

If the object is already connected to Tag Logging runtime (entry in the left half of the window), you can then set the archive tags.

If there is no connection to Tag Logging runtime, a connection must be established via the "Connect..." button.

2. Click on the "Archive Data Selection" entry in the "Name" column. The "Edit..." button can be selected now.
3. Click the "Edit..." button to open the dialog in which you can select the archive tags.

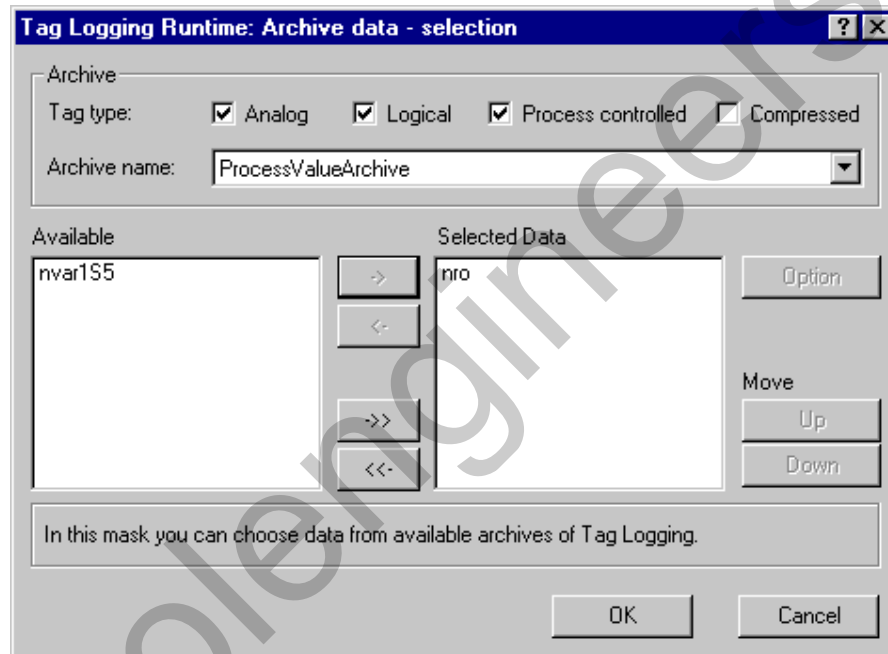

4. Select one or more "Tag Types".
5. Select an "Archive Name" from the list of available archives. The archive tags are displayed in the list of available tags.
6. Select the desired tags from the list of available tags and transfer them individually or in groups to the list of selected tags using the appropriate buttons in the dialog.
7. In the right half of the window (selected), select the appropriate tag and then click the on "Properties" button to determine the display of the trend.

---

#### Note:

The selection time range is also displayed with trends in the trend title.

Use the "Selection" tab in the "Print Jobs" editor to set the time range of the data for the report output.

---

### How to Set the Time Range of the Tags:

1. Ensure that the connection to the archive (process value archive or compressed archive) has been established.
2. In the "Properties" dialog, click on the "Time Selection" entry in the "Name" column. The "Edit..." button can be selected now.
3. Click the "Edit..." button to open the dialog in which you can set the time range.

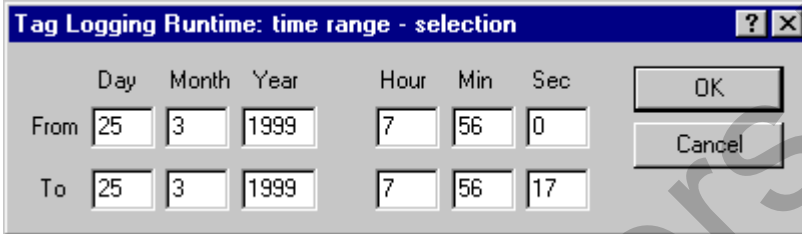

	Day	Month	Year	Hour	Min	Sec	
From	25	3	1999	7	56	0	OK Cancel
To	25	3	1999	7	56	17	

4. In the top line, enter the start date, and in the bottom line, enter the end date for the data output.

---

#### Note:

The editor recommends the current time in the "Time Range" dialog. However, the "From" line is always preset with zero seconds when displaying the current time.

---

### How to Set the Value Range of the Tags:

1. Ensure that the connection to the user archive has been established.
2. In the "Properties" dialog, click on the "Data Selection" entry in the "Name" column. The "Edit..." button can be selected now.
3. Click the "Edit..." button to open the dialog in which you can set the value range.

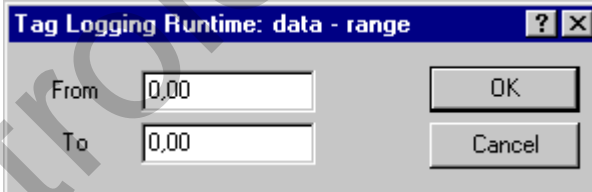

From	0,00	OK Cancel
To	0,00	

4. In the top line, enter the start value, and in the bottom line, enter the end value for the data output.

### How to Set the Trend Display

1. Ensure that the dialog for selecting the tags is selected.
2. Select the appropriate entry in the right half of the window (selected). You can make multiple selections. Then click on the "Properties" button. The dialog in which you can set the trend display opens.

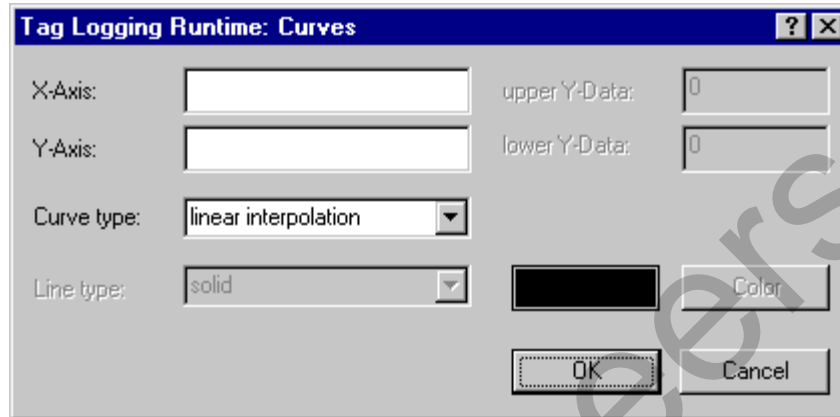

3. Enter the axis labels for the X axis and Y axis.
4. From the list of trend shapes, select one of the following: Linear interpolation, points only or stepped trend

### How to Set the Trend Format:

1. Ensure that the connection to a "Dynamic Table" has been established for the trend display of a user archive.
2. In the "Properties" dialog, click on the "Format" selection in the "Name" column.
3. Click the "Edit..." button to open the dialog in which you can set the trend format.

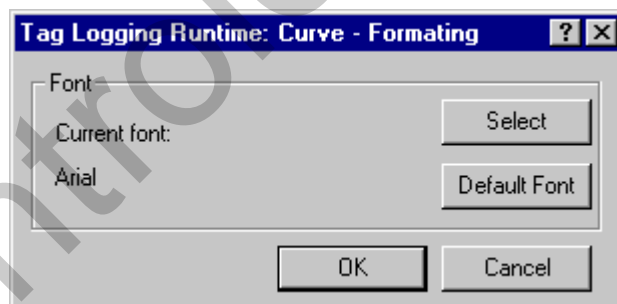

4. By clicking on the "Select" button, you can select a new font. All Windows fonts are available,  
or  
Click on the "Default Font" button to load the default font.

### Tag Logging Runtime - Multiple Outputs of a Tag in a Report

With the help of the Report Designer, you can output values of a tag with different time windows in a WinCC report.

#### Application Examples:

You can output a reference trend and the current values in a report. The output can occur for one or more measurement points.

You can compare a measurement point with different acquisition timers in a report.

#### How to Configure a Tag Multiple Times in a Report:

1. Ensure that you have already connected a dynamic object with Tag Logging runtime, and have determined the output range for the selected tag.
2. In the page layout, select this dynamic object and copy or duplicate the object, and place it in the layout.  
The connected tags with their time ranges will also copied.
3. For tags, change the time window of the copied object,

	Day	Month	Year	Hour	Min	Sec	
From	25	3	1999	7	56	0	OK Cancel
To	25	3	1999	7	56	17	

or

For boxes, change the value range of the copied object.

From	0.00	OK Cancel
To	0.00	

## 4.2 Object Types and Their Properties

For a complete description of the object types and their properties, please consult the Online Help of the Report Designer.

controlengineers.ir

## Index

### A

Alarm Logging 4-1, 4-22  
 Align 3-17  
 Alignment of Objects 3-12  
 Alignment Palette 3-12  
 Archive Logging 4-15  
 Attribute  
   Change table 3-25  
   Changing 3-25  
   Setting Character Set 3-25  
   Setting color 3-25  
   Setting Fill Pattern 3-25  
   Setting Line Type 3-25  
   Setting Line Weight 3-25  
   Setting text 3-25  
   Setting value 3-25

### B

Body of the Page 2-6

### C

Character Set 3-25  
 Color Palette 3-2  
 Colors  
   Default color 3-3  
   User-defined colors 3-3  
 Computer Logging 4-3  
 Connect 3-25  
 Connect Dynamic Objects 3-25  
 Contents of Report 2-4, 3-16  
 Cover Sheet 2-3, 3-16

### D

Default Color 3-3  
 Duplicate 3-15  
 Dynamic Objects 3-5  
 Dynamic Part 3-16  
 Dynamic part of the report 2-7

### E

Enlarge Section 3-16

### F

Fill Pattern 3-25  
 Final Page 2-4, 3-16  
 Font Palette 3-22  
 Footer  
   Line layout 2-11  
 Formatting Tag List 4-4

### G

Global Script 4-7  
 Graphics Designer 4-9  
 Grid 3-16  
   Aligning on grid 3-18  
   Display 3-18  
   Setting 3-18

### H

Header  
   Line layout 2-10

### L

Layer 3-17  
 Layout  
   Create 2-13  
   Delete 2-14  
   Open 2-13  
   Rename 2-14  
   System layout 2-24  
   System layouts 2-26  
 Line Layout 2-1, 2-8  
   Create layout 2-13  
   Delete layout 2-14  
   footer 2-11  
   Header 2-10  
   Open layout 2-13  
   Print 2-12  
   Print To... 2-8  
   Rename layout 2-14  
   System layout 2-26  
 Line Layouts 3-34  
   Editing line layouts 3-34  
   Editor 3-34  
 Line Type 3-25  
 Line Weight 3-25



Linie 4-32  
 Logging Actions 4-13  
 Logging Archive Tags 4-18  
 Logging compressed archive 4-15  
 Logging Languages 4-20  
 Logging Process Value Archive 4-15  
 Logging Tag Groups 4-4  
 Logging Tag Parameters 4-4  
 Logging Times 4-14  
 Logging User Archive 4-15

## M

Matrix Printer 2-8  
 Menu Bar  
   Set representation 3-18  
 Menu Commands 3-14, 3-34  
 Message Sequence Report 2-8  
 Move an Object 3-9  
 Move Down One Layer 3-17  
 Move Up One Layer 3-17  
 Multiple Selection 3-7  
   of objects 3-8

## O

Object 3-17  
   Changing ending angle 3-10  
   Changing starting angle 3-10  
   Connect 3-25  
   Connect dynamic objects 3-25  
   Move 3-9  
   Move Down One Layer 3-17  
   Move Up One Layer 3-17  
   Place On Bottom 3-17  
   Place On Top 3-17  
   Presetting 3-8  
   Properties 3-23  
   Selecting 3-7  
   Selecting multiple objects 3-7, 3-8  
   Set size 3-9  
 Object List 3-23  
 Object Palette 3-3  
 Object Properties 3-23, 4-32  
 Object Selection 3-18  
 Object Tree Selection 3-18  
 Objects 4-32  
   Aligning 3-12  
   Drawing 3-6  
   Dynamic objects 3-5  
   Presetting 3-6  
   Selection 3-18  
   Static objects 3-4

System objects 3-6  
 Unify sizes 3-12  
 Online Reporting 2-1

## P

Page Layout 2-1, 2-2  
   Body of the page 2-6  
   Contents of report 2-4  
   Cover sheet 2-3  
   Create layout 2-13  
   Delete layout 2-14  
   Dynamic part of the report 2-7  
   Editing 3-1  
   Editor 3-1  
   Final page 2-4  
   Open layout 2-13  
   Print 2-12  
   Printable area 2-5  
   Rename layout 2-14  
   Static part of the report 2-6  
   System layout 2-25, 2-26  
 Page Layouts 3-1  
 Pin 3-23  
 Pipettes 3-23  
 Place On Bottom 3-17  
 Place On Top 3-17  
 Polygon  
   Drawing 3-6  
 Polyline  
   Drawing 3-6  
 Presetting  
   Object 3-8  
   Objects 3-6  
 Print 3-15  
   Print job 2-16, 2-19  
   Print jobs 2-12  
 Print Job 2-19  
   Create 2-16  
   Data selection 2-19, 2-20  
   Delete 2-19, 2-23  
   Preview 2-16  
   Print 2-17  
   Properties 2-18  
   Selecting printer 2-19  
   System print job 2-24, 2-26  
   System print jobs 2-26  
 Print Jobs 2-16  
 Printable Area 2-5  
 Printer  
   Print To... 2-8  
 Process Value  
   Set time range 4-26  
   Set trend format 4-26

- Set trend representation 4-26
- Setting range of values 4-26
- Process Value Logging 4-26
- Project Documentation 2-1, 4-1
  - Actions 4-8, 4-13
  - Archive 4-15
  - Archive tags 4-18
  - Compressed archive 4-15
  - Computer 4-3
  - Functions 4-8
  - Global Script 4-7
  - Graphics Designer 4-9
  - Languages 4-20
  - Logging 4-1
  - Object data 4-10
  - Picture data 4-10
  - Picture properties 4-12
  - Picture statistics 4-11
  - Process value archive 4-15
  - Single messages 4-2
  - Tag groups 4-4
  - Tag logging 4-14
  - Tag parameters 4-4
  - Tags 4-4
  - Text library 4-20
  - Times 4-14
  - User archive 4-15
  - WinCC Explorer 4-3
- Properties 3-15
- Property
  - Assign property 3-15
  - Copy property 3-15

## R

- Redo 3-15
- Report
  - in line layout 2-8
- Report Designer 1-1
- Report Layouts 4-1
- Reports 2-1
  - in page layout 2-2
- Output 2-16, 2-19
- Print 2-12
- Runtime Log
  - Alarm logging 4-22
  - Compressed archive 4-26
  - Message blocks 4-22
  - Process value 4-26
  - Process value log 4-26
  - Sequence archive log 4-22
  - Short-term archive log 4-22
  - Tag 4-26
  - Tag logging 4-26

- User archive 4-26

## S

- Save All 3-15
- Select All 3-15
- Selecting an Object 3-7
- Selection
  - Multiple objects 3-7
- Set Message Blocks 4-22
- Set Size 3-9
- Set Units 3-18
- Set Units of Measure 3-18
- Setting Ending Angle 3-10
- Setting Fill Pattern 3-12
- Setting Line Type 3-11
- Setting Line Weight 3-11
- Setting Starting Angle 3-10
- Settings 3-18
- Single Messages Protocol 4-2
- Static Objects 3-4
- Static Part 3-16
- Static part of the report 2-6
- Status Bar 3-22, 3-35
- Style Palette 3-10
- System Layouts 2-25, 2-26
- System Objects 3-6
- System Print Jobs 2-25

## T

- Table
  - Changing the column width 3-25
  - Changing the number of columns 3-25
- Tag Logging 4-4, 4-14, 4-26
- Text Library 4-20
- Toolbar 3-20, 3-35
  - Set representation 3-18
- Toolbars 3-16

## U

- Undo 3-15
- Unifying Sizes 3-12
- User-Defined Color 3-3

## W

- WinCC Explorer 4-3

## Z

Zoom 3-16

Zoom Factor 3-13

Zoom Palette 3-13

controlengineers.ir

## SIMATIC HMI

## WinCC

Manual  
Volume 1 / 2

### Volume 1

Preface	1
System Overview	2
Authorization	3
WinCC Explorer	4
Channels	5
Report Designer	6
User Administrator	7

### Volume 2

Graphics Designer	8
Alarm Logging	9
Tag Logging	10
Text Library	11
Global Script	12
Cross Reference	13

This manual is part of the documentation package with the order number: 6AV6392-1XA05-0AB0

Edition August 1999

WinCC®, SIMATIC®, SIMATIC NET®, SINEC® and STEP® are Siemens registered trademarks.

All other product and system names in this manual are (registered) trademarks of their respective owners and must be treated accordingly.

(The reproduction, transmission or use of this document or its contents is not permitted without express written authority. Offenders will be liable for damages. All rights, including rights created by patent grant or registration of a utility model or design, are reserved.)

(We have checked the contents of this manual for agreement with the hardware and software described. Since deviations cannot be precluded entirely, we cannot guarantee full agreement. However, the data in this manual are reviewed regularly and any necessary corrections included in subsequent editions. Suggestions for improvement are welcomed.)

© Siemens AG 1994 - 1999 All rights reserved

Technical data subject to change

C79000-G8276-C159

Printed in the Federal Republic of Germany

Siemens Aktiengesellschaft

# Table of Contents

<b>1</b>	<b>Functional Principle of the User Administrator .....</b>	<b>1-1</b>
1.1	User Administrator Configuration System .....	1-1
1.2	User Administrator Runtime System .....	1-1
1.3	Tasks of the User Administrator .....	1-1
<b>2</b>	<b>Structure of the User Administrator configuration system.....</b>	<b>2-1</b>
2.1	The Project Window .....	2-2
2.1.1	Navigation Window.....	2-2
2.1.2	Table Window.....	2-2
2.2	The Menu Bar.....	2-3
2.2.1	"File" Menu .....	2-3
2.2.2	"User" Menu .....	2-4
2.2.3	"Table" Menu .....	2-7
2.2.4	"Chipcard" Menu.....	2-7
2.2.5	"AddOns" Menu .....	2-8
2.3	Toolbar .....	2-11
2.4	Status Bar .....	2-11
2.5	Procedures .....	2-11
2.5.1	Structure of a Password Manager.....	2-11
2.5.2	Selecting an Authorization.....	2-12
2.5.3	Operating in the Runtime System .....	2-12
2.6	Appendix User Administrator.....	2-13
2.7	WinCC Options for the User Administrator .....	2-16
2.7.1	Menu Addition.....	2-17
2.7.1.1	Chip Card .....	2-17
2.7.2	Chip Card Reader in Runtime .....	2-18

controlengineers.ir

# 1 Functional Principle of the User Administrator

The User Administrator editor is used to assign and monitor user access authorization to the individual editors of the configuration and runtime systems. To this end, access authorization to WinCC functions is granted when configuring the users and is assigned to the each user individually. Up to 999 different authorizations can be assigned. User authorizations can be assigned during run time.

When a user logs on to the system, the User Administrator checks to see if the user is registered. If the user is not registered, he/she has no rights in the system. This means that the user is able to call up or view any data, nor control any process.

If a registered user calls up a function, the User Administrator checks whether the user has authorization. If not, the User Administrator refuses access to the desired function.

The User Administrator also incorporates the configuration functions for the "Variable Login" function, which a user can use, for example, to log on to the workstation by means of a key switch.

The User Administrator is divided into two components for assigning user authorizations.

## 1.1 User Administrator Configuration System

The User Administrator configuration system manages the users. When new users are entered, the system assigns passwords and records the user authorizations in a table.

## 1.2 User Administrator Runtime System

The main task of the User Administrator runtime system is to monitor the system logons and access authorizations. This applies on the configuration level as well as the runtime level.

## 1.3 Tasks of the User Administrator

The User Administrator carries out the following tasks:

- Creating and changing users (max. 128) and groups (max. 10)
- Assigning and managing access authorizations
- Setting up access protection
- Selective protection from unauthorized access to individual system functions
- Logging off a user after a certain length of time, in order to prevent unauthorized access.
- Configuring the "Variable Login" function.





controlengineers.ir

## 2 Structure of the User Administrator configuration system

The user interface of the "User Administrator" editor consists of a:

- Menu Bar
- Toolbar
- three-section Project Window
- Status Bar.

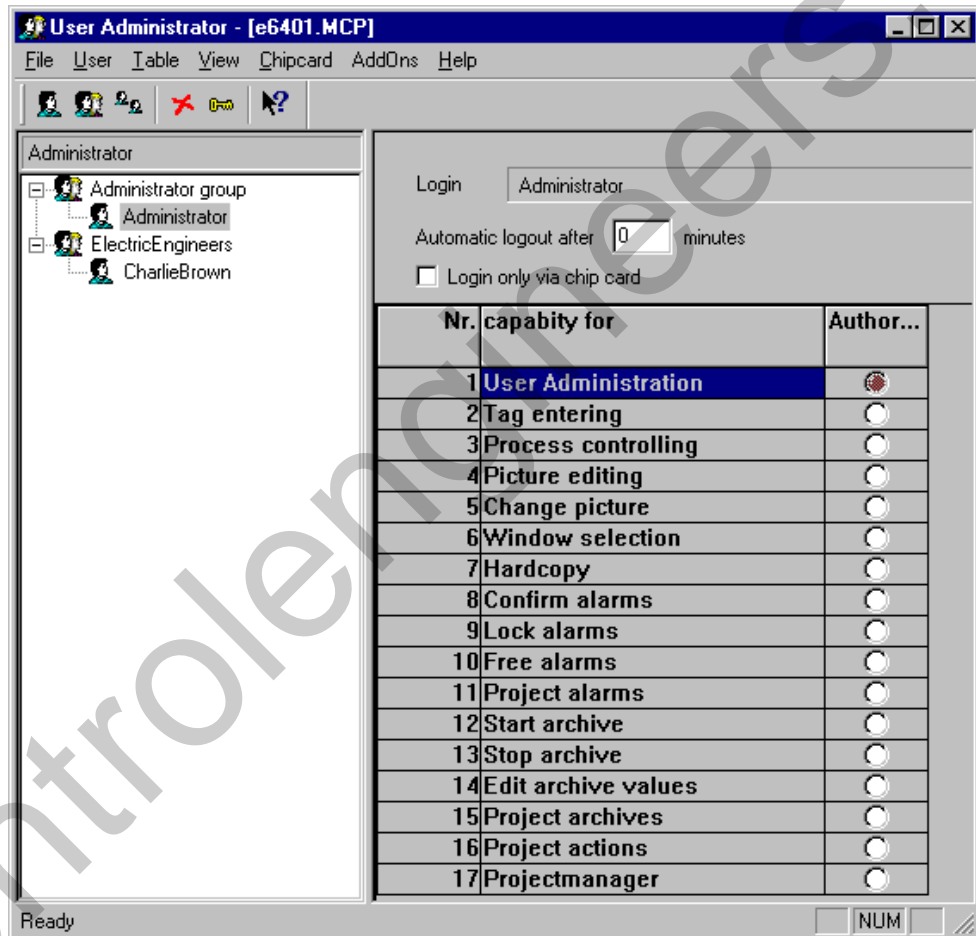

## 2.1 The Project Window

The project window consists of:

- the Navigation Window on the left
- and the two-section Table Window on the right.

### 2.1.1 Navigation Window

The navigation window contains a tree structure view of the groups that have been set up and the corresponding, registered users. Your user name is entered in the box with the gray background at the top of the navigation window. Click the right mouse button on the selected user or selected user group to open the pop-up menu for the user.

### 2.1.2 Table Window

The top of the table window contains the login name or the user identifier. The settings displayed in the table window all relate to this particular user.

Directly beneath the name, there is a box for setting an automatic logout. This way, you can block unlimited access to the system by external users after you have made a change. If you enter "0," the access is not closed until after the system is turned off.

---

**Note:**

The time configured for automatic logout starts running from the moment the user logs in, irrespective of whether the user uses the program or not. After automatic logout of a user, a new or the previous user is still able to log on in the runtime system.

---

If a user is to be permitted to log in only by means of his/her chipcard, you can set this by selecting "Login only via chip card". The check box is beneath "Automatic logout after" .

---

**Note:**

The "Login only via chipcard" check box is displayed if you have installed the "Chipcard" option. A chipcard reader does not necessarily have to be connected to your configuration computer. This has been set up in this way so that you can set up the function and use it on other WinCC computers without there being a card reader installed during configuration.

---

The bottom area of the table window displays a list of the authorizations that are set up. Each line represents an authorization. The number of authorizations displayed depends on the options installed, e.g. Split Screen Wizard ("Basic Process Control" option).

In the "Authorization" column, you assign the respective authorization to the selected user by double-clicking in the desired line.

Authorization level 1 "User Administration" is preset as the default for the users in the "Administrator" group. You cannot edit this box.

You must assign authorizations individually. Multiple authorizations can only be transferred optionally according to the group assignment when you create a new user in a group. A maximum of 999 authorizations can be assigned to the table by means of the "Table" menu option.

## 2.2 The Menu Bar



All of the commands available in the User Administrator configuration system are divided logically into groups and assigned to different menus in the Menu Bar. To execute a command, open the appropriate menu, click on the command and, if necessary, set the required parameters.

---

### Note:

The explanations presented below only refer to those menu commands that will not already be familiar to you from other Windows applications or whose functional scope goes beyond that familiar. Information about these menu commands can be found in the QuickTips for the individual editors.

---

### 2.2.1 "File" Menu

#### Print Project Documentation Project Documentation View Printer Setup

Use the command "Print Project Documentation" to print the message system to the set printer. The template for the printout is the page layout "@ALGCS.RPL", which can be changed with the "Report Designer". The project documentation provides information about the configured single and group messages, the used message blocks, message classes and message types as well as about the configured archives.

The command "Project Documentation View" is used to obtain a preview of the project documentation.

Use the command "Printer Setup" to specify the printer to be used and the page layout.

---

### Note

Additional information on printing project documentation can be found in Chapter Project Documentation in the System Overview.

---

## 2.2.2 "User" Menu

The "User" menu contains all of the menu items needed to set up new users or groups. You can group users that have or will receive the same authorizations. Those users will then receive the same authorizations as the group. This way, you can avoid having to assign the same authorizations within a group manually.

### Adding a Group

Use the "Add Group" option in the "User" menu to add a new group. There are no subgroups.

#### How to Add a New Group:

1. Select the "Add Group" option from the "User" menu or from the appropriate pop-up menu.

A new group will be set up in the project navigation window. A text box with a cursor is then displayed next to the group icon.

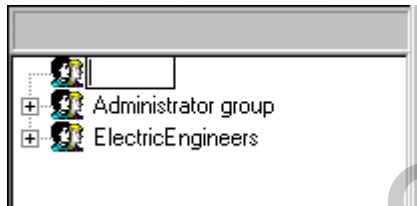

2. Enter the name for the new group.
3. Assign the desired authorizations.

---

#### Note:

A group name can only be assigned once. You can set up a maximum of 10 groups.

---

### Adding a User

Use the "Add user..." menu option in the "User" menu to add a new user to the selected group.

Enter the required parameters in the "Establish new user" dialog window.

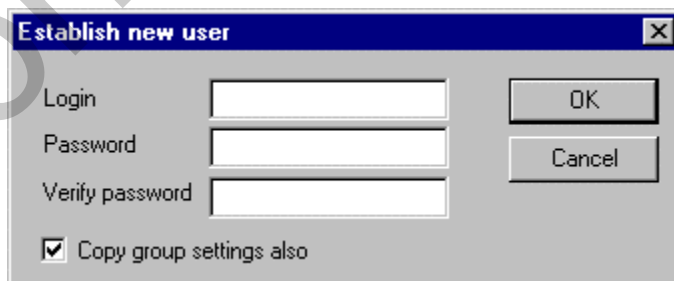

Name	Description
LoginLogin	Identification of the user with a length of 4 to 24 characters. It appears as a user name in the tree in the navigation window.
Password	User password. It must be between 6 and 24 characters long.
Verify password	Additional entry of the password to check it. Reenter the password.
Copy group settings also	If this check box is selected, all of the group settings are copied.

**Note:**

A user name can only be assigned once. You can set up a maximum of 128 users.

**Copying a User**

Use the "Copy user..." menu option in the "User" menu to copy the selected user with all associated settings.

Enter the required parameters in the "Copy user ..." dialog box.

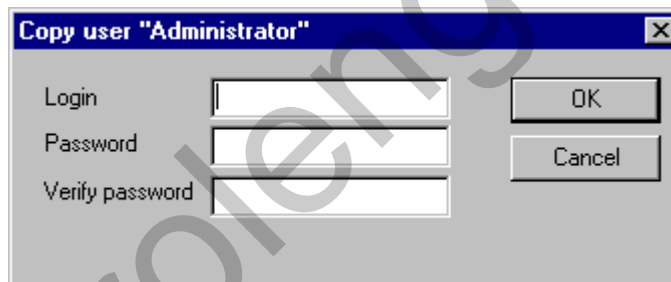

Name	Description
LoginLogin	
Password	User password. It must be between 6 and 24 characters long.
Retype Password	Additional entry of the password to check it. Reenter the password.

**Note:**

A login user name can only be assigned once. It appears in the tree view in the project navigation window.

### Deleting a User/Group

Use the "Delete user/group" menu option to delete the selected user or group.

The selected object is removed.

### Changing the Password

Use the "Change password" menu option in the "User" menu to assign a new password to the selected user.

Enter the required parameters in the "Copy user ..." dialog box.

Name	Description
Login	Identification of the user with a length of 4 to 24 characters. It appears as a user name in the tree in the navigation window.
Password	Old user password. It must be between 6 and 24 characters long.
New password	New user password. It must be between 6 and 24 characters long.
Verify password	Additional entry of the password to check it. Reenter the password.

---

**Note:**

The login name of the user is abbreviated in the dialog (max. 22 characters).

---

### Changing a Name

You can change the name of a user or a group. Changing a name does not affect the password of this user.

---

**Note:**

A user name can only be assigned once. It appears in the tree view in the project navigation window.

---

### 2.2.3 "Table" Menu

Use the "Table" menu to change or expand the user authorizations in the table window. Only the user administration function cannot be deleted. It is permanently set for members of the "Administrator" group.

#### Inserting an Authorization

Use the "Insert authorization" command to add a new line to the table in the table window.

---

**Note:**

New authorizations can only be set up in the configuration system.

---

#### Deleting an Authorization

Use this command to delete a line from the table of authorizations.

The selected object is removed.

---

**Note:**

The system does not allow you to delete a number of specific authorizations. If you delete an authorization, it is deleted for all of the entered users. Authorizations can only be deleted in the configuration system.

---

### 2.2.4 "Chipcard" Menu

You can activate this menu only when the "Chipcard" option is installed. You can get additional information from the manual for this option package.



## 2.2.5 "AddOns" Menu

This menu contains additional functions.

### Variable Login

The "Variable Login" function is used to assign a value of a tag to a specific user. This enables this user to log on to a workstation during runtime by setting the tag value, e.g. by means of a key switch.

You configure this function by means of the following steps:

1. Assign an operator station to a configured tag (Computer assignment)
2. Specify a minimum and a maximum value for a tag to be used for the variable login function (Configuration)
3. Assign a specific tag value to a specific user (User assignment)

By setting the tag value to logout value, the user is able to log out again after completing his work.

As long as a user is logged on in the system by means of "Variable Login", it is not possible to log on to the same computer via the user dialog.

### Assigning a Computer to a Tag

The "Computer assignment..." menu option opens a dialog that is used to assign a computer to a specific, configured tag.

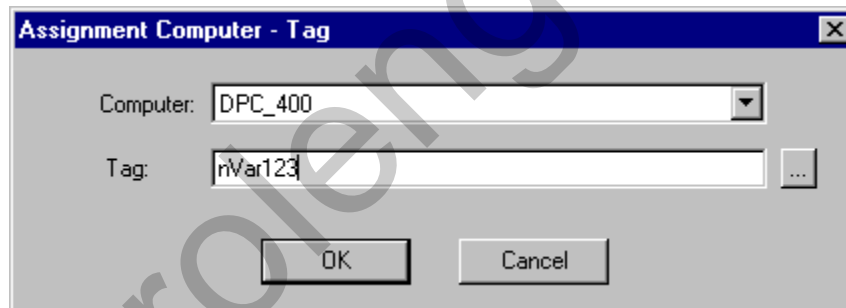

Name	Description
Computer	Is used to select a computer. All the clients and multi-clients of the project are displayed.
Tag	In this box, you can enter a tag name directly or select one via the "Select Tag" dialog. You can use all types of tags.

#### Note:

The tag used can indeed be of any type, but only the type "Integer" makes sense for an application with a key switch, since the switch outputs values from 0 to 10.

### Configuration

The "Configuration..." menu option opens a dialog used for specifying the minimum and maximum values of a variable that is used by the "Variable Login" function.

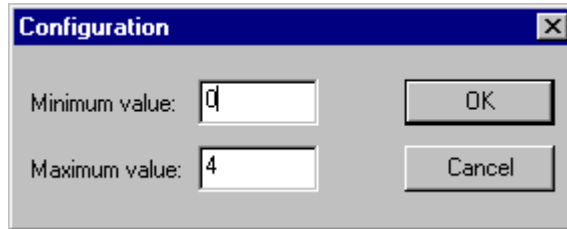

Name	Description
Minimum value	This is where you specify the minimum value of the tag. Value range: 0 - 32767
Maximum value	Specifies the maximum value of the tag. The value entered must be greater than the minimum value. Value range: 1 - 32767

### Assigning a User Value

The "User assignment..." menu option opens a dialog that is used to assign a variable value to a specific user.

If a user has already been selected in the User Administrator before the start of this dialog, an existing assignment is displayed directly in the dialog.

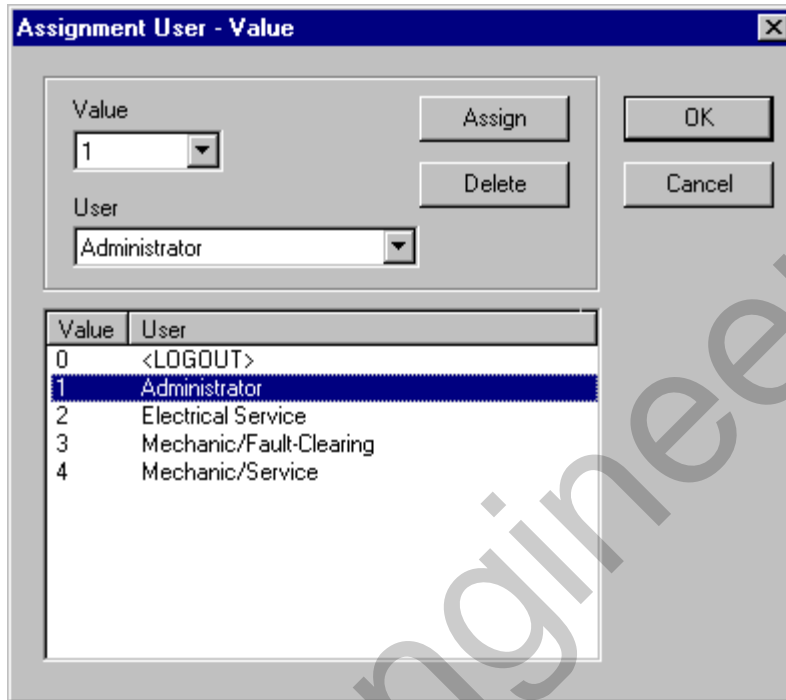

Name	Description
"Value" box	Is used to select a value from the table. Which values can be selected is defined by the setting in the "Configuration" dialog.
"User" box	Use this box to select a user created in the User Administrator.
"Assign" button	Once you have made a selection in the "Value" and "User" boxes, use button to specify the assignment and display it in the table.
"Delete" button	Use this button to delete an assignment selected in the table.
"Value - User" table	This table displays the variable values that can be selected ("Configuration" dialog) and the existing assignments to a user.

**Note:**







Each tag value can be assigned to only one user.

A "user" in the User Administrator can also be set up to represent a user group or a function, e.g. the user "Service" or "Fault-Clearing".

## 2.3 Toolbar



These icons allow you to execute actions more rapidly. You do not have to make several selections through the menus until you reach the required function.

Icon	Description
	"User" "New user"
	"Group" "New group"
	"User" "Copy user"
	"User" "Delete user/group"
	"User" "Change password"
	"Help"

## 2.4 Status Bar

On the left side of the status bar you see general informations about the program. You can find out about the meaning of the boxes on the right side of the bar from the "WinCC Explorer" section of the user manual.

## 2.5 Procedures

The User Administrator provides for splitting up the users into two levels. You can assign each of your colleagues with a password to exactly one group. It is logical to assign users to a group based on the authorizations that the users are granted.

### 2.5.1 Structure of a Password Manager

#### How to Construct Your Password Manager:

1. Create the necessary groups.
2. Select the appropriate authorizations for each group.
3. Create the users. Copy the group properties in the process. Assign the appropriate login names and passwords.
4. Select the specific authorizations for each user. If you want, you can set a time here after which the system will automatically log out the user in order to protect the system against unauthorized inputs. You can also specify here whether or not the user will be able to log on only by means of his or her chipcard.

The data are applied without storing them.

## 2.5.2 Selecting an Authorization

If you want to assign authorizations from another editor, the following dialog appears.

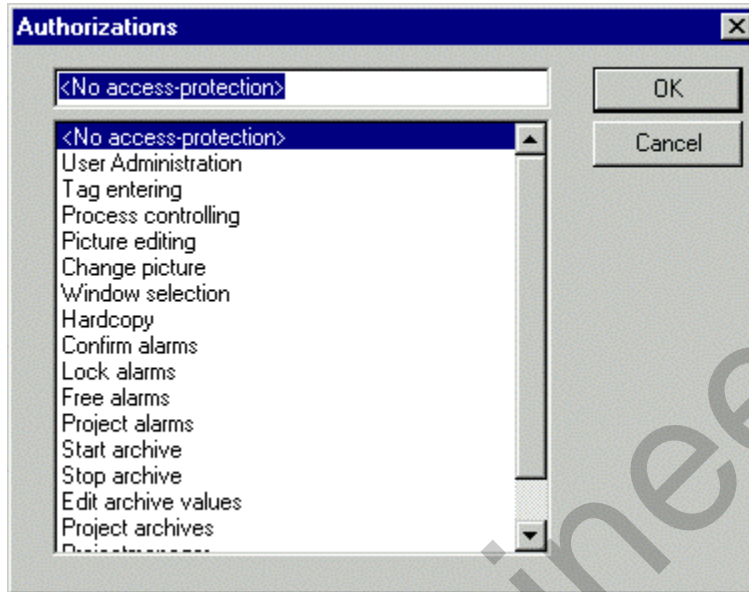

It contains the authorizations in accordance with the numbering sequence. If you select an authorization here, only users that have the appropriate authorization can execute the function or operate in runtime.

1. You can open the dialog in a number of ways, e.g. by means of the "Authorization" attribute of the properties of an option group in the Graphics Designer.
2. Select the desired authorization.
3. Exit the dialog box.

## 2.5.3 Operating in the Runtime System

Start the runtime system. Use the key combination set in the WinCC Explorer (by means of Project Properties, Hotkeys tab) to open the password dialog box.

Enter your login name and your password.

The system checks the authorizations assigned to you with the authorizations of the editors and the components created and enables these authorizations for use if they match up.

You can find out how to set key combinations in the "Hotkeys Tab" area of the WinCC Explorer manual.

## 2.6 Appendix User Administrator

### Standard User Authorizations

When you enter the "User Administrator" editor, the table window is preset with specific authorizations.

With the exception of "User Administration", you can delete or change any of the authorizations in the table.

A member of the "Administrator Group" always receives access to User Administration. The authorizations are assigned in the configuration system but affect the runtime system exclusively. They can prevent a user who is logged on to the run-time system from having access to all of the system sections.

---

#### Note:

The names of the authorizations show the area of influence for the corresponding authorization but do not show how you use them.

---

The authorizations are preset by WinCC as follows:

#### User Administration

This authorization is used by WinCC in this context.

If this item is active, you can call up the User Administrator and make changes.

#### Tag entering

When active, you can manually enter values, e.g. for actual or setpoint values for I/O fields.

#### Process controlling

You can use this option to get the user to perform operating functions, e.g. manual/auto switchover.

#### Picture editing

Can be used to assign the user authorization to use the Graphics Designer.

#### Change picture

If this option is active, it enables the user to trigger a change of picture in runtime and thus to open a different configured picture.

#### Window selection

This option enables the user to change the application windows in Windows.

#### Hardcopy

Enables the user to make copies of the screen.

#### Confirm alarms

Enables the user to confirm alarms.

#### Lock alarms

Enables the user to lock alarms.

#### Free alarms

Enables the user to free (enable) alarms.

**Project (i.e. configure) alarms**

Grants the user authorization to configure or change alarms in the Alarm Logging editor.

**Start archive**

Grants the user authorization to configure the start of an archiving process.

**Stop archive**

This item enables the user to configure the end of an archiving process.

**Edit archive values**

Grants the user authorization to configure (project) values of archive tags.

**Project archive values**

If active, this option enables the user to configure (project) Tag Logging.

**Project actions**

Grants the user authorization to configure the Global Scripts.

**Project manager**

Enables the user to access the WinCC Explorer.



### User Hierarchies PCS7)

User Authorizations after activating the "Split Screen Wizard" (Basic Process Control Option).

Authorizations can be added, deleted or their names changed in the configuration system. The following preset authorizations cannot be deleted, but their names can be changed.

#### User Administration

This authorization is used by WinCC in this context.

If this item is active, you can call up the User Administrator and make changes.

#### Plant picture change

This authorization is used by WinCC in this context.

If this option is active, the user is able to trigger a picture change during runtime and in this way to call up a different configured picture.

#### Systemchange

This option can be used e.g. to grant authorization to change server.

#### Monitoring

Grants the user authorization to monitor the process only during runtime, but not operate it.

#### Processcontrolling

When active, this level has the user carry out operations during runtime.

#### Higher Processcontrolling

This authorization is used by WinCC in this context.

This option can be used to grant authorization for drastic process operations.

#### Reportsystem

Grants the user authorization to use the Report Designer to start or change reports.

#### Archive controlling

If this option is active, the user may well be able to start and stop the archiving of tags and editing of values.



## 2.7 WinCC Options for the User Administrator

If WinCC is installed with the options, the functionality of the User Administrator is expanded.

For example, the Split Screen Wizard ("Basic Process Control" option) changes the number of authorizations displayed in the table window.

The "chip card reader" option adds the menu "Chipcard" to the menu bar together with its associated functions and the "Login only via chip card" check box in the table window can also be activated.

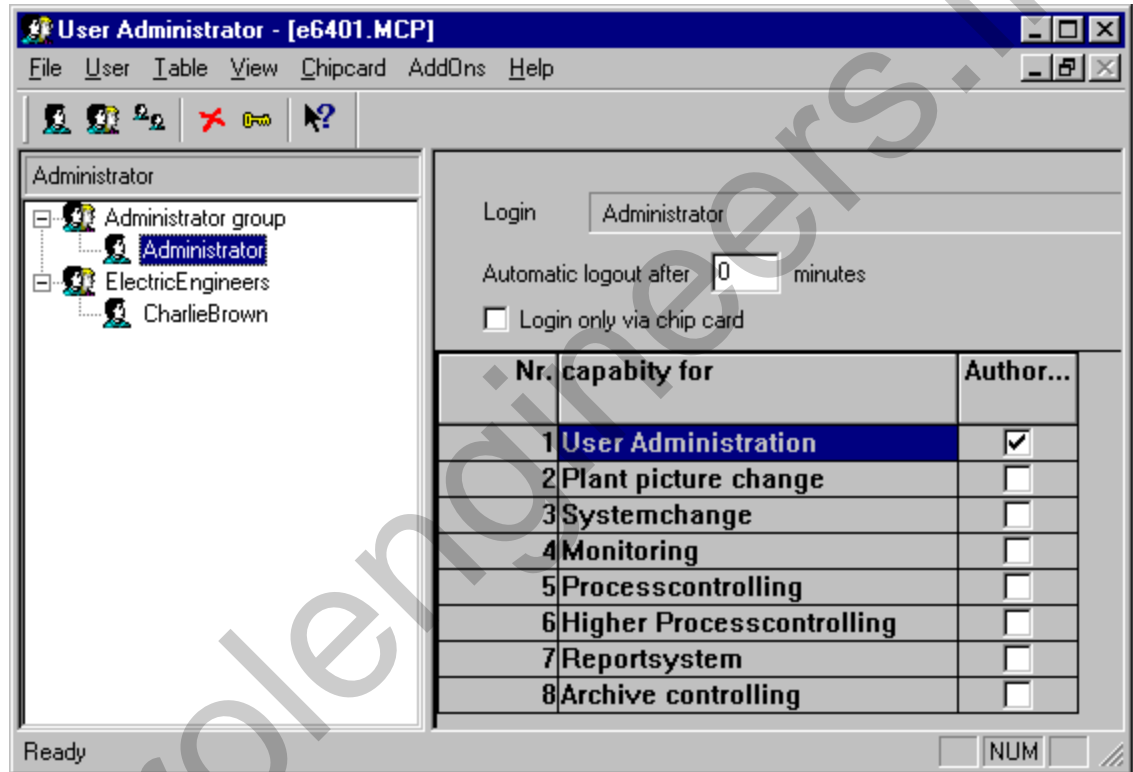

## 2.7.1 Menu Addition

### 2.7.1.1 Chip Card

The User Administrator provides functions to control a chip card reader/writer. You can write and check chip cards in the configuration system.

---

**Note:**

This menu can only be activated, if WinCC has been installed with the "Chipcard" option and an interface (COM1 or COM2) has been assigned via the "WinCC Chipcard Terminal" dialog in the Windows Control Panel.

---

To activate the menu in the User Administrator, install the WinCC "Chip Card" option and then carry out the following steps:

1. Open the "WinCC Chipcard Terminal" option in the Windows Control Panel.
2. In the "WinCC Chipcard Terminal Configuration" dialog that is opened, activate the option button "Terminal active".
3. Under "Connection", select the desired interface and close the dialog by clicking the "OK" button.

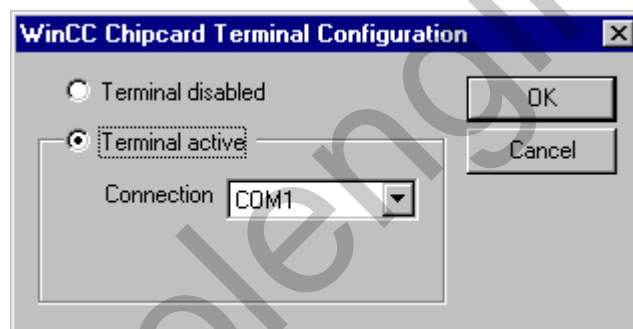

When you then open the User Administrator, the "Chipcard" option will be displayed in the menu bar.

If you activate the "Terminal disabled" option button in the "WinCC Chipcard Terminal Configuration" (Control Panel) dialog, the "Chipcard" option in the menu bar will be hidden again after you have restarted the User Administrator.

### Write To Chip Card

When you write to a chip card, all of the data on the card are deleted. The user (login name) and the password are stored on the chip card.

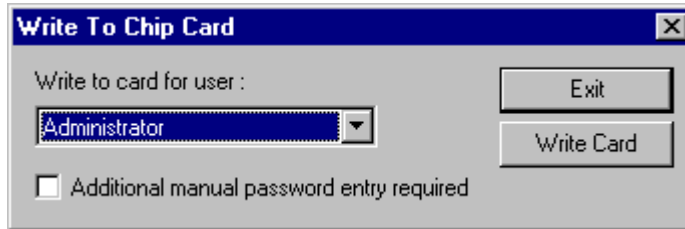

---

#### Note:

You can only activate this menu if WinCC has been installed with the "Chip Card" option.

---

### Check Chip Card

To check whether the data was entered correctly, you can read from the chip card.



The login identification for the card user is entered after "Name" and the text "Card is valid" also appears. If there is an error when reading the chip card, it is noted in this dialog. No user name is provided.

---

#### Note:

You can only activate this menu if WinCC has been installed with the "Chip Card" option.

---

## 2.7.2 Chip Card Reader in Runtime

When you log on to Graphics Designer run time, insert your chip card in the reader and the necessary data are read. When the card is inserted, you cannot log on to the system manually. You remain logged on the system until you remove your card from the reader. The time switch does not log you out when you are working with a chip card.

---

#### Note:

To drive a chip card reader, WinCC must be installed with the "Chip Card" option.

---

## Index

### A

Action Configuration 2-13  
 Add Group 2-4  
 Archive  
   Start 2-13  
   Stop 2-13  
 Archive Configuration 2-13  
 Assign Computer 2-8  
 Authorization 2-2  
   Assigning 2-12  
   Default authorization 2-13  
   Delete 2-7  
   Insert 2-7  
   Selecting 2-12  
 Automatic Logout 2-2

### C

Changing Password 2-6  
 Chip Card 2-17  
   Checking 2-18  
   Operation at Runtime 2-18  
   Writing 2-17  
 Configuration 2-8, 2-9

### E

Edit Archive Values 2-13  
 Entering Values 2-13  
 Exchange Pictures in the Plant 2-13

### G

Group Delete 2-5

### H

High-Order Process Controlling 2-13

### K

Key-Operated Switch 2-8

### L

Login  
   at Runtime 2-12  
   only with chip card 2-2

### M

Menu Bar 2-3  
 Message  
   Acknowledge 2-13  
   Lock 2-13  
   Release 2-13  
 Message Configuration 2-13  
 Monitoring 2-13

### N

Navigation Window 2-2

### O

Operating an Archive 2-13

### P

Password Administration 2-11  
 Picture Configuration 2-13  
 Picture Exchange 2-13  
 Print 2-3  
 Print Screen 2-13  
 Printer Setup 2-3  
 Process Controlling 2-13  
 Project Documentation  
   Preview 2-3  
   Print 2-3  
 Project Manager 2-13

### R

Report System 2-13  
 Runtime  
   Login at Runtime 2-12

## S

Status Bar 2-11  
System Change 2-13

## T

Table Window 2-2  
Tag Login 2-8  
    Assign a computer 2-8  
    Assign a user 2-9  
    Configuration 2-8, 2-9  
Toolbar 2-11

## U

User  
    Add 2-5  
    Assign 2-9  
    Delete 2-5  
    Delete group 2-5  
User Administration 2-11, 2-13

## W

WinCC Chip Card Terminal 2-17  
Window Selection 2-13